

Flat, Sticks, Top

VIBIA

VIBIA

New Collections

Flat
6

Sticks
44

Top
74

Flat

Design by Ichiro Iwasaki.

Flat's distinctive, disc-shaped diffusers form horizontal planes of light that integrate with the surrounding architecture. A study in geometry, the collection creates layers of light that infuse a space with a soothing, Zen sensibility.

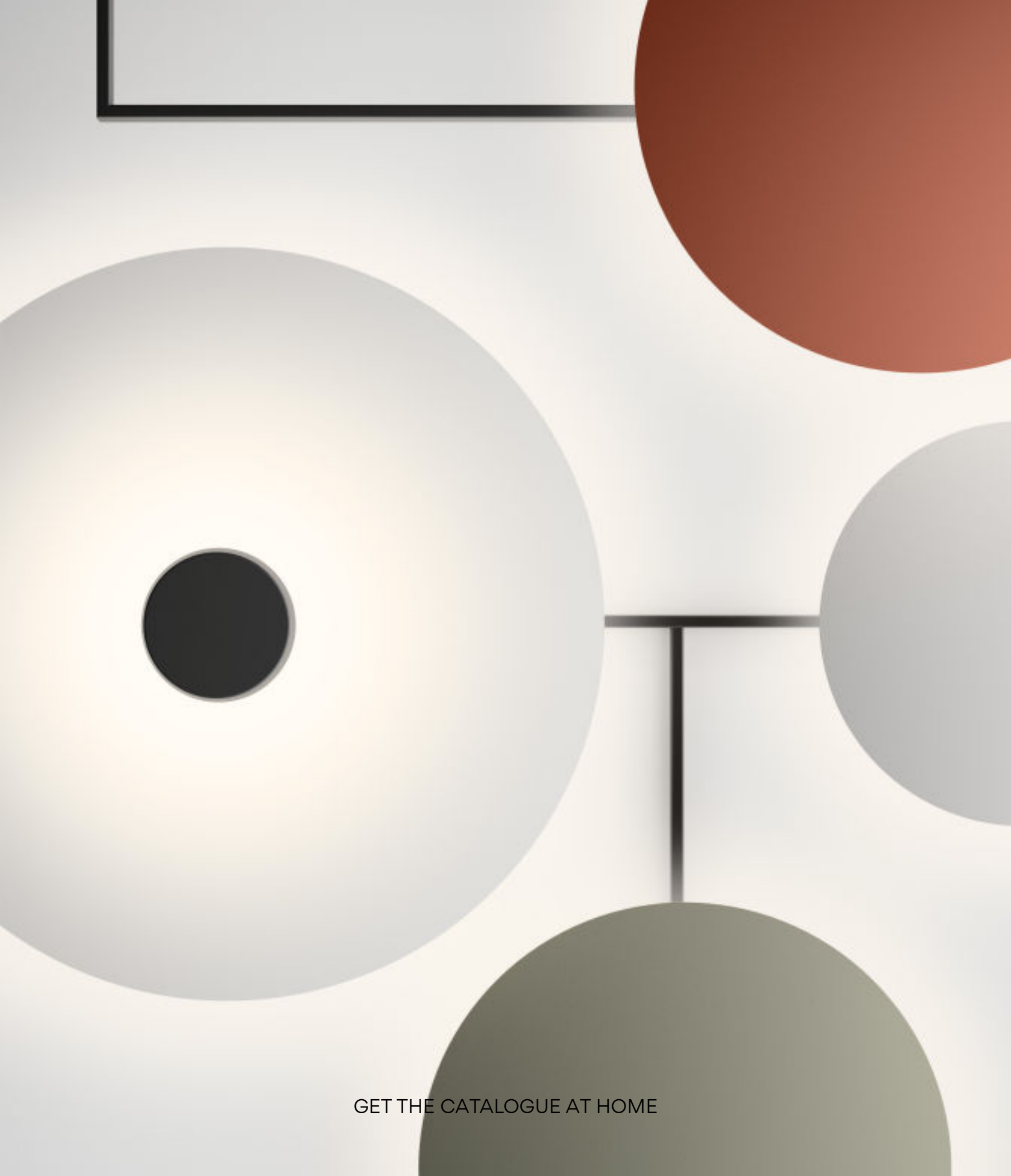

GET THE CATALOGUE AT HOME









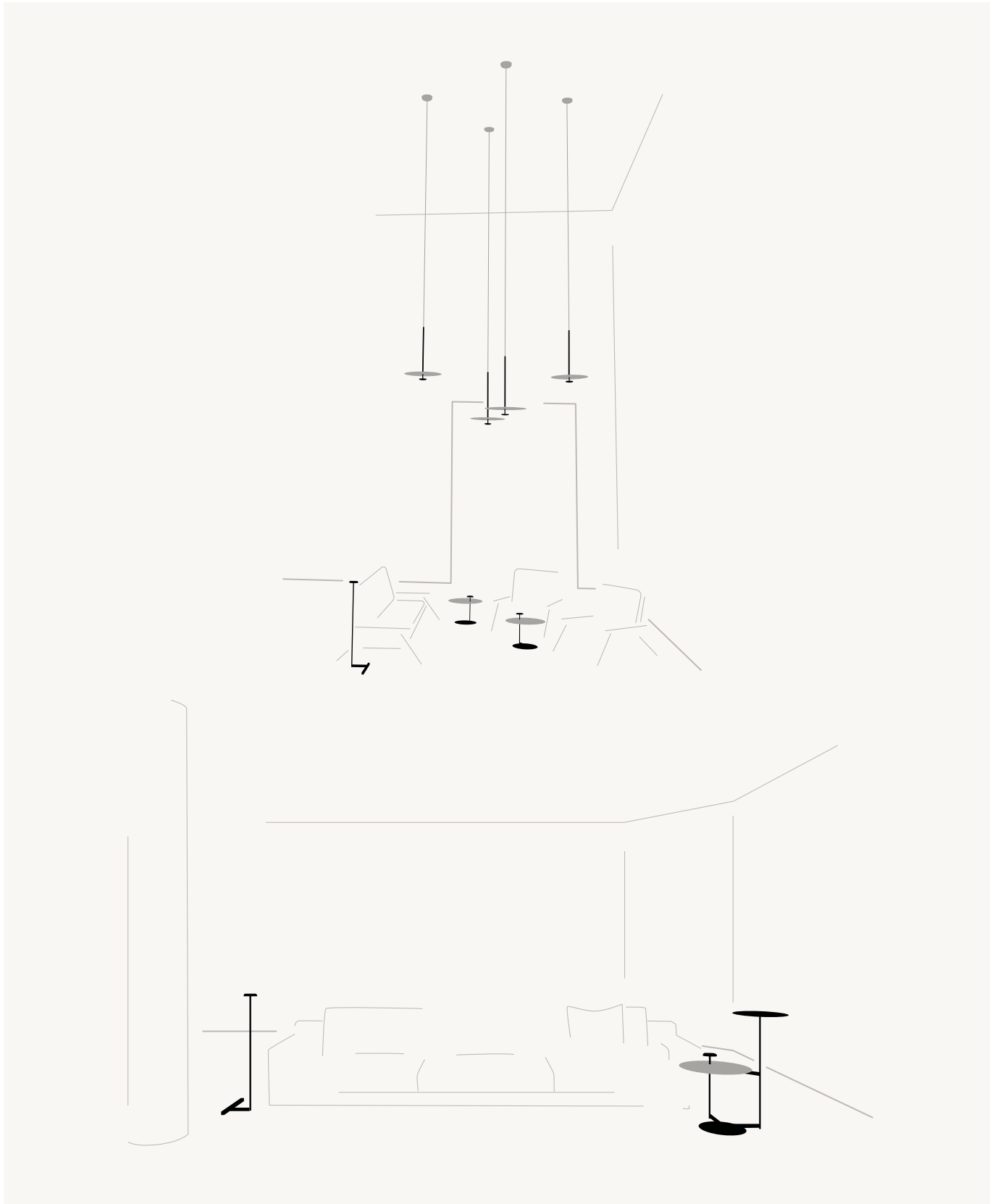



Ref. 5945
One general on/off and dimming
switch for both discs.



FLOOR

15



GET THE CATALOGUE AT HOME







The LED-powered collection features flat metal plates reflecting light off their surface, casting an enveloping, wraparound glow that appears illuminated from within. The floor lamp comes in small and large sizes, with a single or double plate - either a compact disc or a shelf-like plate that doubles as furniture. When deployed in pairs, the smaller, complementary disc captures and reflects light back at the larger plate, creating pockets of soft, pooled indirect light that illuminate both the space and the surface itself.

Ref. 5945, 5957.

- 13 Grey L1 (NCS S 1000-N)
- 47 Green L1 (NCS S 4005-G80Y)

Ref. 5950.

- 10 White (NCS S 0300-N)

Ref. 5955.

- 11 Black (NCS S 8500-N)
- 37 Terra Red (NCS S 4040-Y70R)
- 47 Green L1 (NCS S 4005-G80Y)

Shade: Aluminum.
 Diffuser: Polycarbonate.
 Structures: Steel.

LED 2700 K. CRI>90
 Dimming: Push.

Ref. 5945
 One general on/off and dimming switch for both discs.

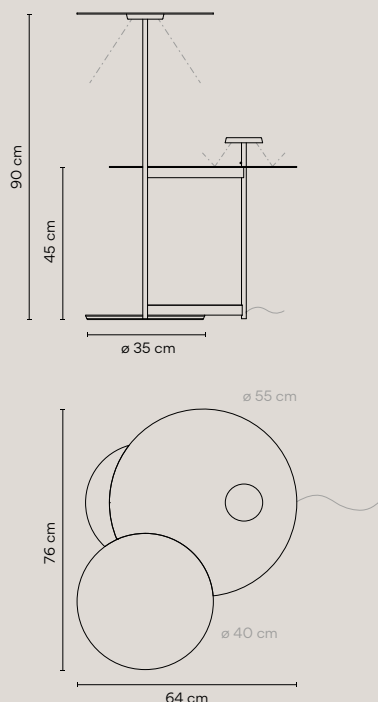

5945

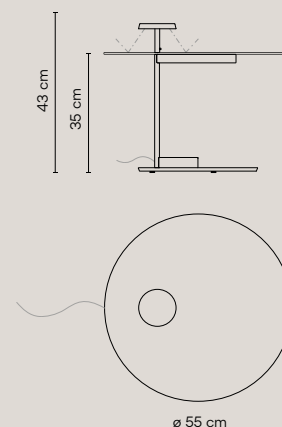

5950

Personalization options available
 - LED 4000 K
 Request more information.

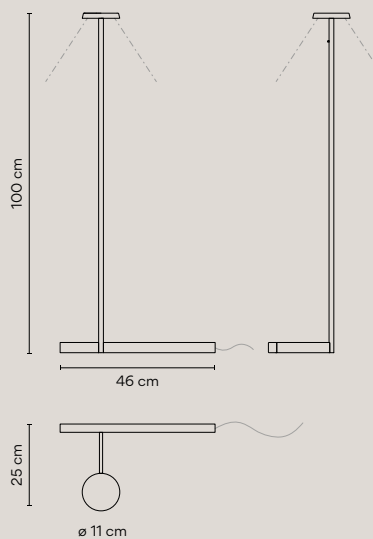

5955

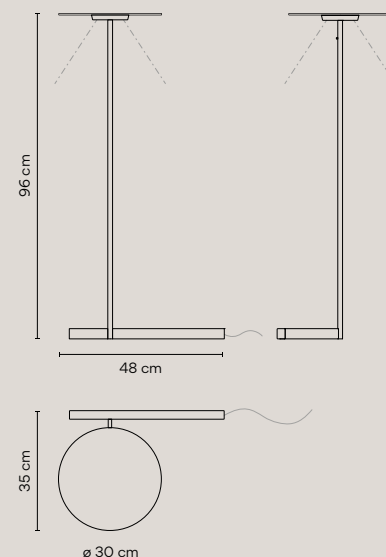

5957



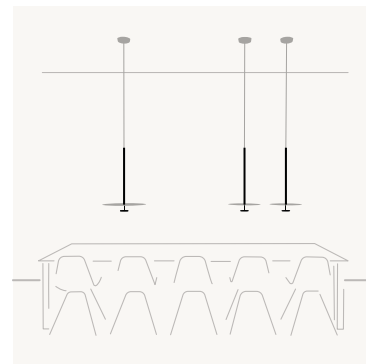
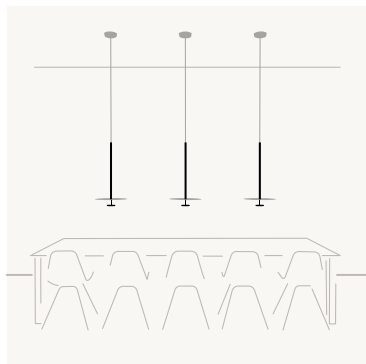
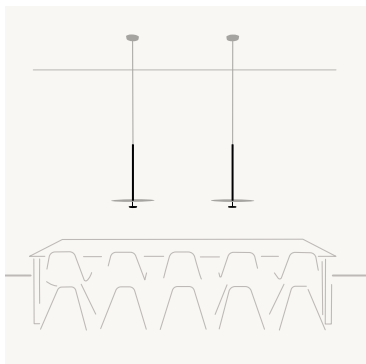

FLAT





GET THE CATALOGUE AT HOME







5935 with remote driver - trimless

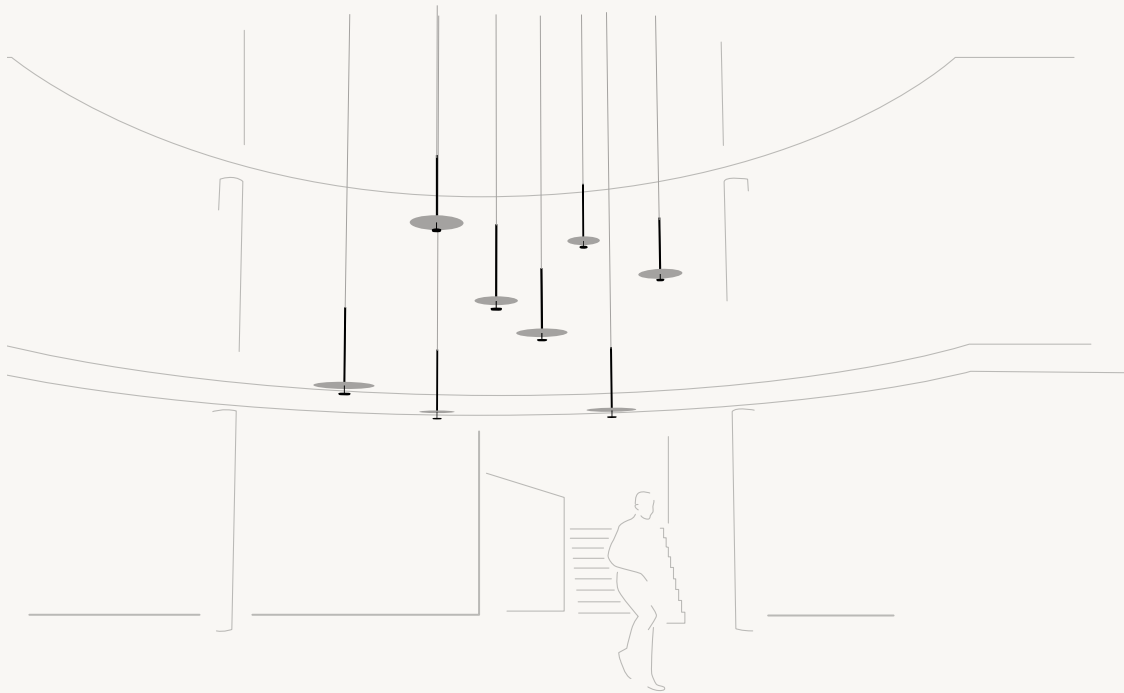
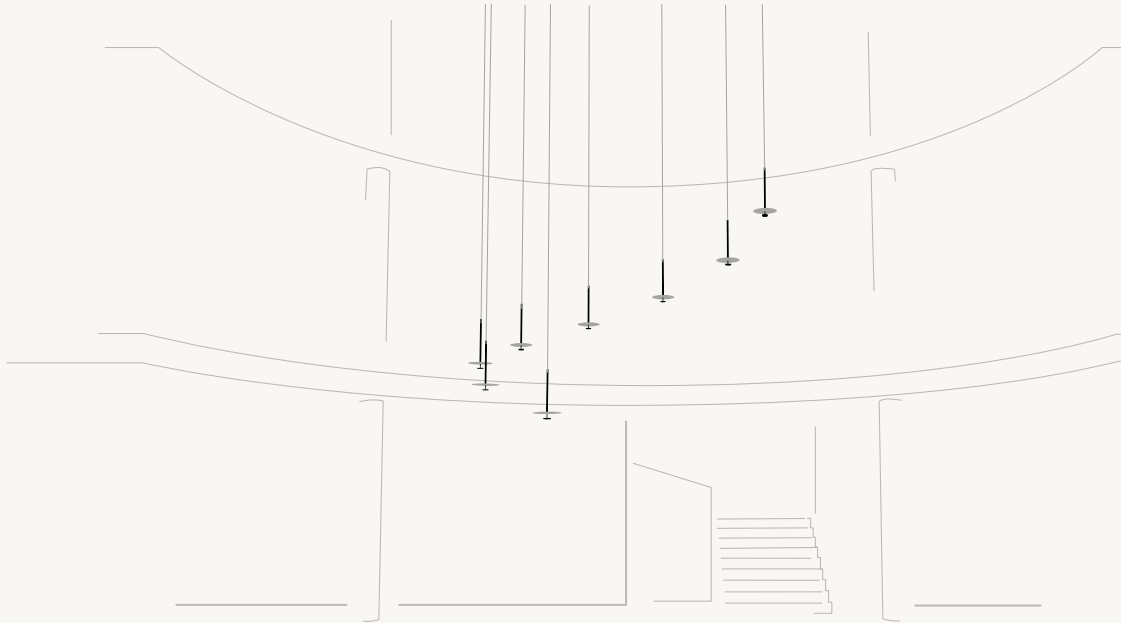



The collection features flat metal plates positioned at different heights. They reflect light from their surface, casting an enveloping, wraparound glow that appears illuminated from within. Suspended by a cable from the ceiling, the pendants are at once delicate and graphic, seeming to float overhead. A large, commercial size pendant with an arm to adjust the height is also available. The small disc reflects light back at the larger disc, creating a pocket of soft, pooled indirect light.

- 13 Grey L1 (NCS S 1000-N)
- 37 Terra Red (NCS S 4040-Y70R)
- 47 Green L1 (NCS S 4005-G80Y)

Shade: Aliminum.
 Diffuser: Polycarbonate.
 Structures: Steel.
 Canopy: Aluminum.

LED 2700 K. CRI>90
 Dimming: DALI, 1-10V, Push.

Personalization options available
 - LED 4000 K
 - Extra cable length
 Ref. 5930.
 - Dimming: Casambi
 Request more information.

Upper side of the disc available in:
 Grey L1, Terra Red y Green L1.

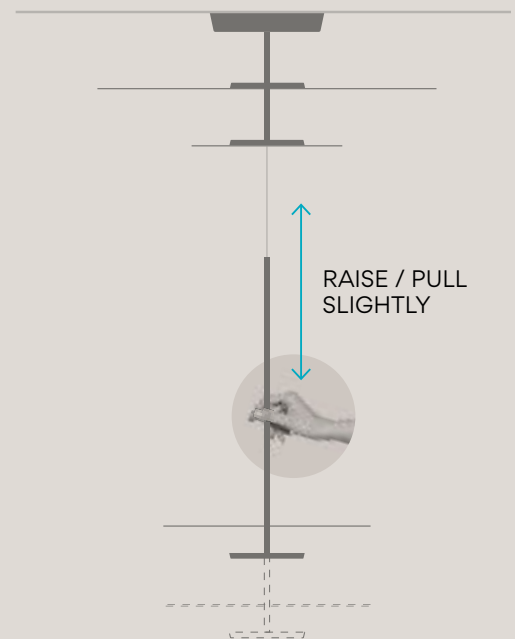
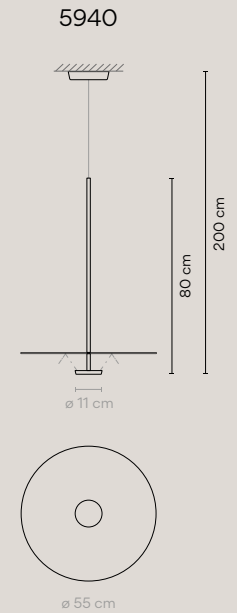
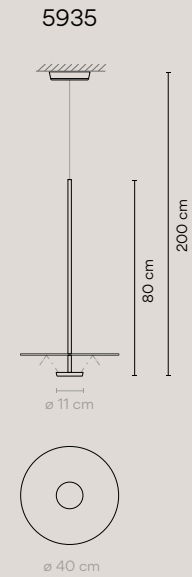
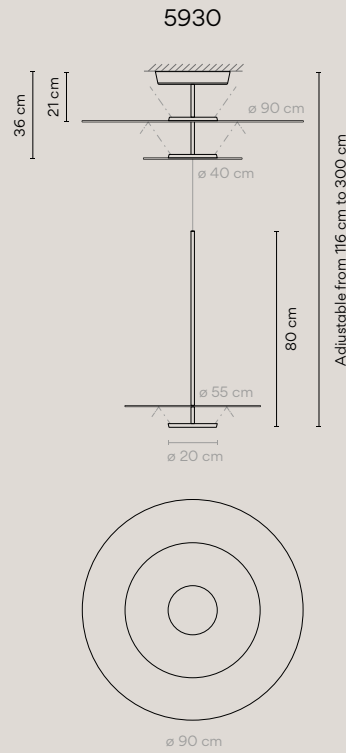
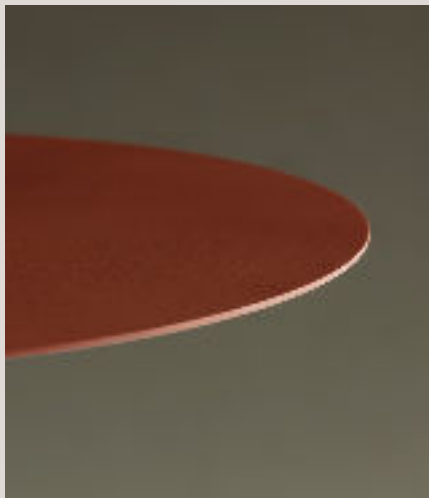





GET THE CATALOGUE AT HOME



The LED-powered collection consists of flat metal plates reflecting light from their surface, casting an enveloping, wraparound glow that appears illuminated from within. The tabletop lamp is available with a compact disc or a shelf-like plate that doubles as furniture, its diminutive proportions lending it an intimate, human sensibility. The light reflects downward, creating a soft luminescence upon the surface on which it rests. A study in geometry, its crisp lines and smooth curves exude sculptural elegance.

Ref. 5965.

- 13 Grey L1 (NCS S 1000-N)
- 47 Green L1 (NCS S 4005-G80Y)

Ref. 5970.

- 11 Black (NCS S 8500-N)
- 37 Terra Red (NCS S 4040-Y70R)
- 47 Green L1 (NCS S 4005-G80Y)

Shade: Aliminum.
Diffuser: Polycarbonate.
Structures: Steel.



LED 2700 K. CRI>90
Dimming: Push.

Personalization options available
- LED 4000 K
Request more information.

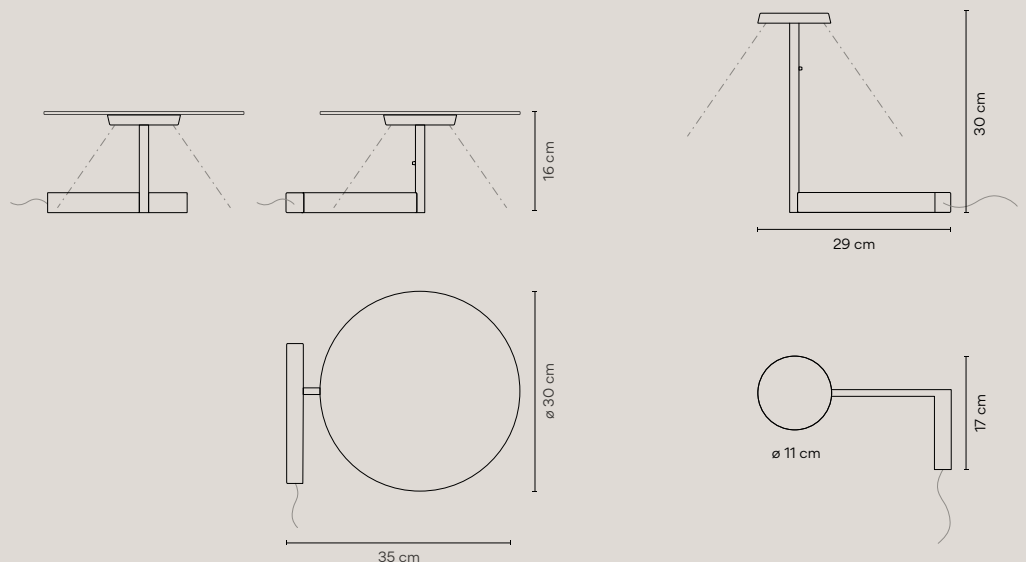

5965

5970



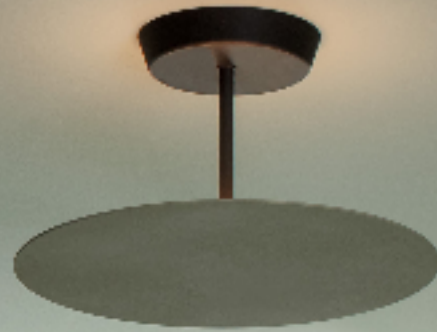





GET THE CATALOGUE AT HOME

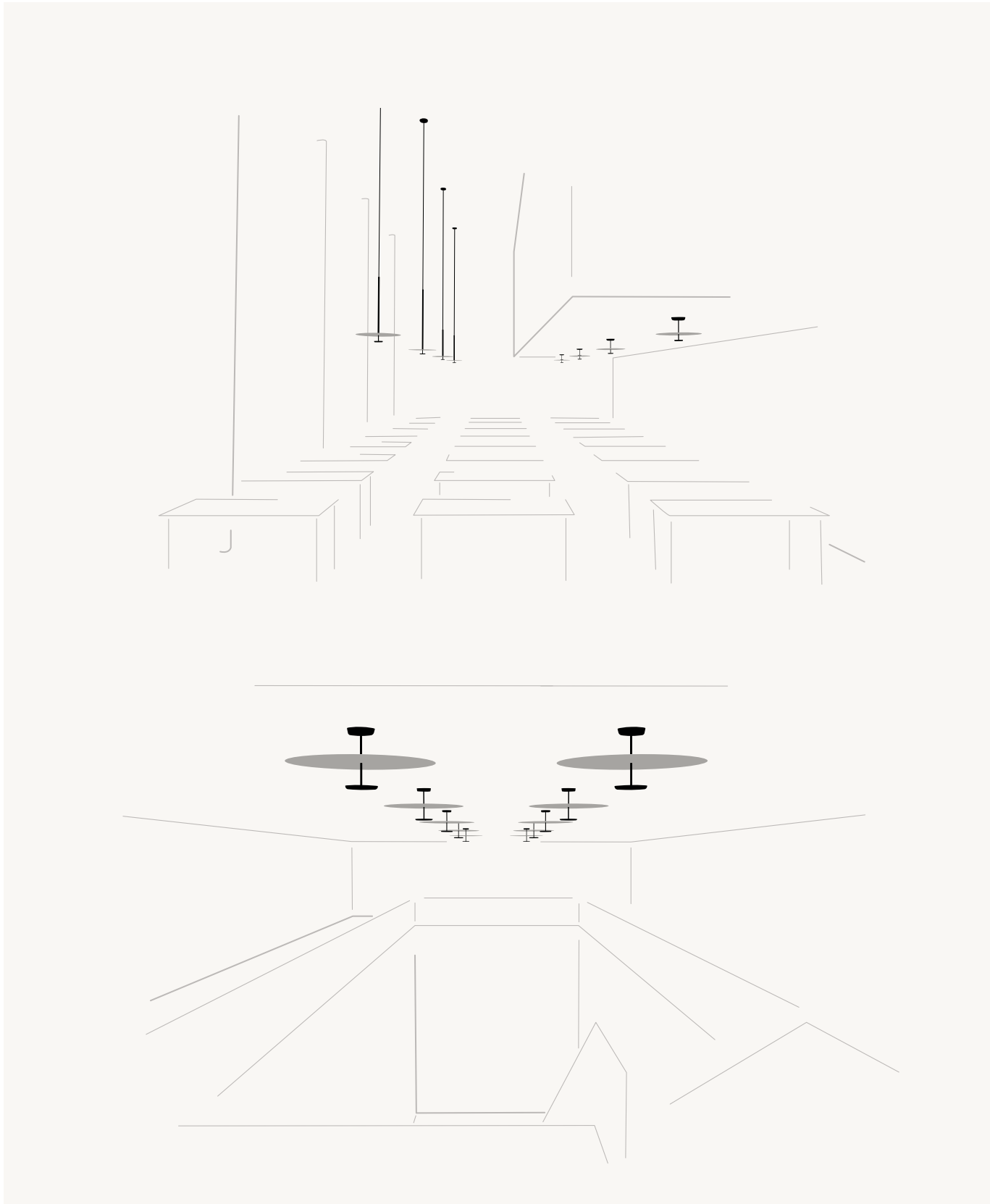







The LED-powered collection is composed of flat metal plates positioned at different heights. The plate surfaces reflect light, casting an enveloping, wraparound glow that appears illuminated from within. At once delicate and graphic, the ceiling light seems to float overhead. It comes in small or large sizes with a single or double disc. The single-disc style reflects indirect light up towards the ceiling, while the double disc's smaller, complementary plate captures and reflects light back at the larger disc, creating a pocket of soft, pooled indirect light. A triple-disc version is available for commercial use.

Ref. 5905, 5922.

10 White (NCS S 0300-N)



71 White, Green L1, Grey L1
(NCS S 0300-N, NCS S 4005-G80Y,
NCS S 1000-N)

Ref. 5910, Ref. 5924.

10 White (NCS S 0300-N)



72 White, Green L1
(NCS S 0300-N, NCS S 4005-G80Y)

73 White, Grey L1
(NCS S 0300-N, NCS S 1000-N)

Ref. 5926, 5915.

10 White (NCS S 0300-N)

Ref. 5920.

10 White (NCS S 0300-N)

13 Grey L1 (NCS S 1000-N)

47 Green L1 (NCS S 4005-G80Y)

Shade: Aliminum.
Diffuser: Polycarbonate.
Structures: Steel.
Canopy: Aluminum.

LED 2700 K. CRI>90
Dimming: DALI, 1-10V, Push.

* Electrical connection point.

Personalization options available

- LED 4000 K

Ref. 5922, 5924.

- Dimming: Casambi

Request more information.

5905

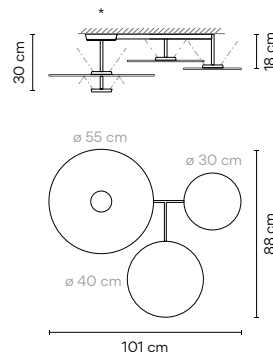

5910

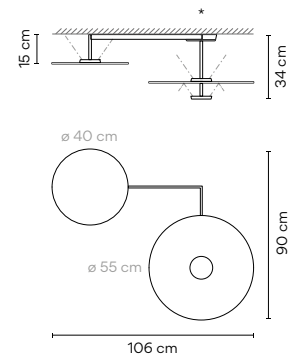

5922

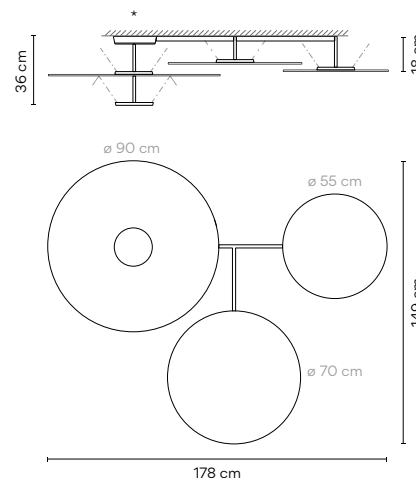

5924

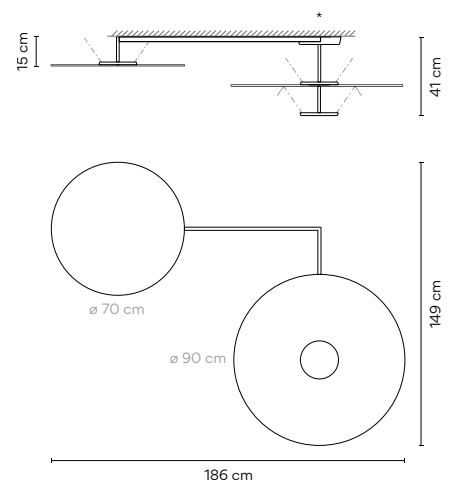

5926

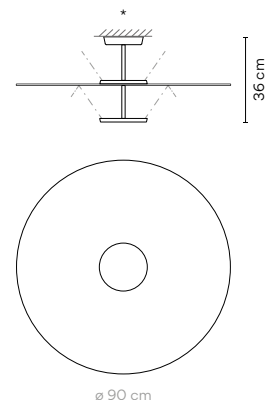

5915

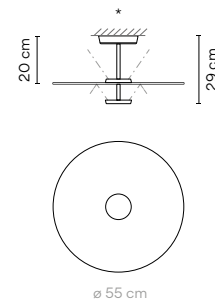

5920

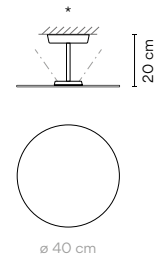

CEILING



“A reflector lamp collection that connects a floating light source with a linear structure. Minimal reflector discs and linear structure provide simple and powerful universality like alphabets and musical scores”.

Ichiro Iwasaki

GET THE CATALOGUE AT HOME

Sticks

Design by Arik Levy.

Fusing technology, space, and architecture, Sticks offers a creative toolkit for integrating light elements in an interior. Pure and graphic, the minimalist aluminum rods transform linear light into floating sculpture.

GET THE CATALOGUE AT HOME













GET THE CATALOGUE AT HOME

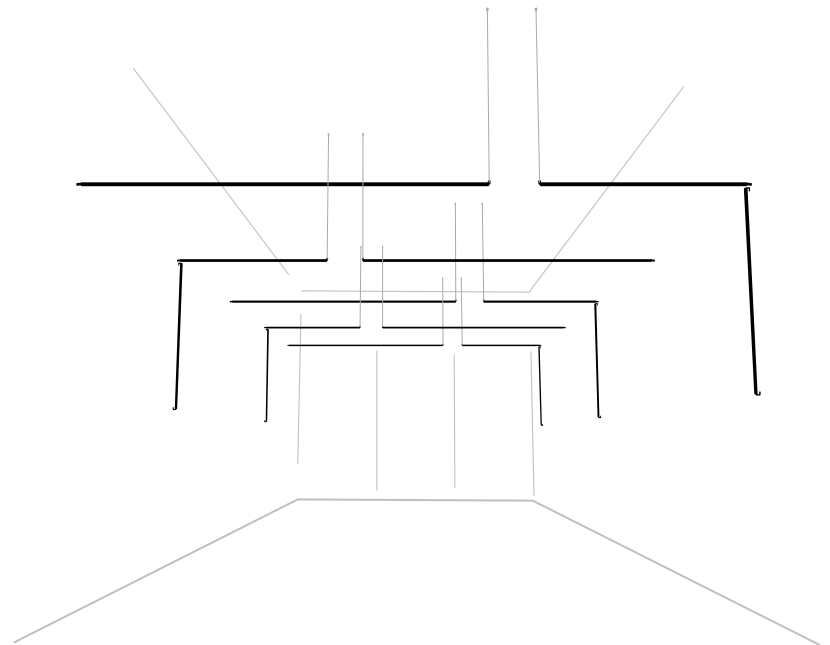



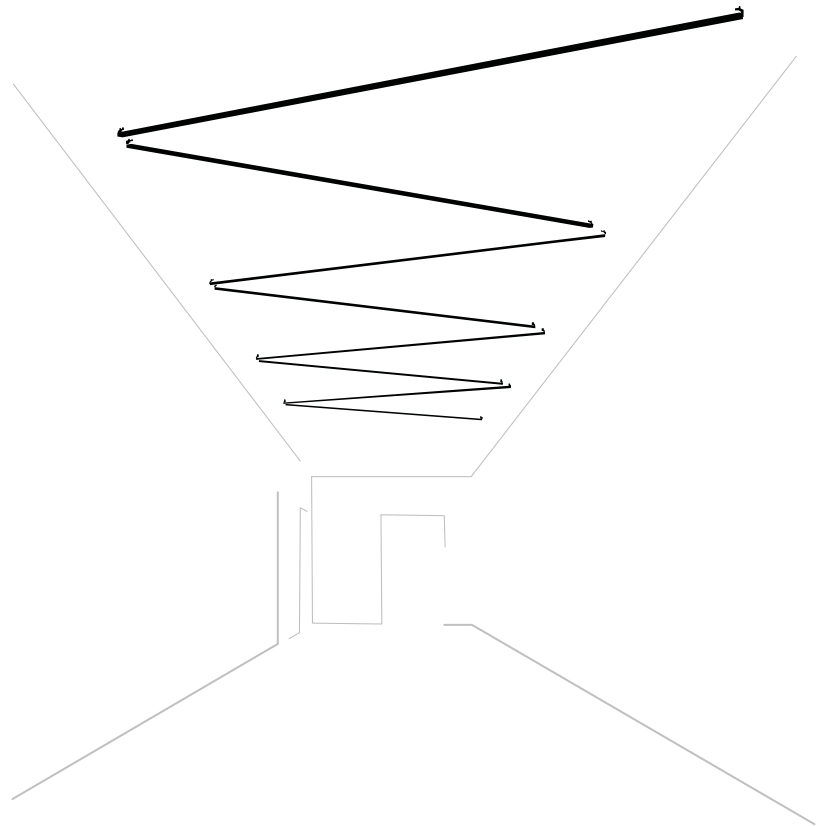



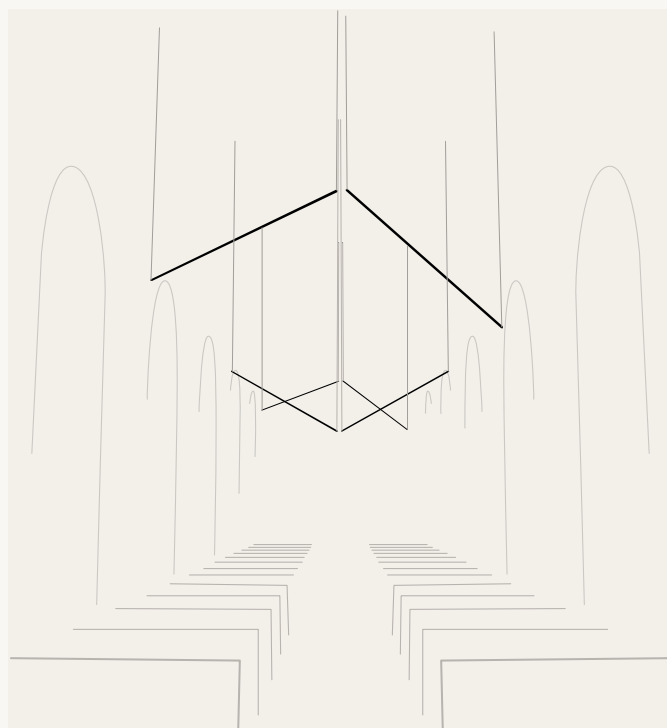
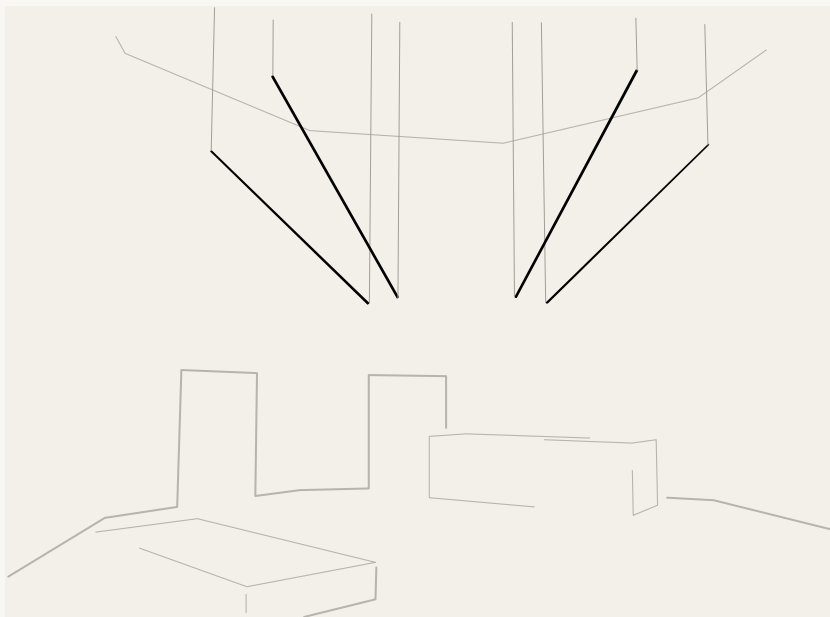



GET THE CATALOGUE AT HOME









Horizontal pendant version
with a UGR index <19 available

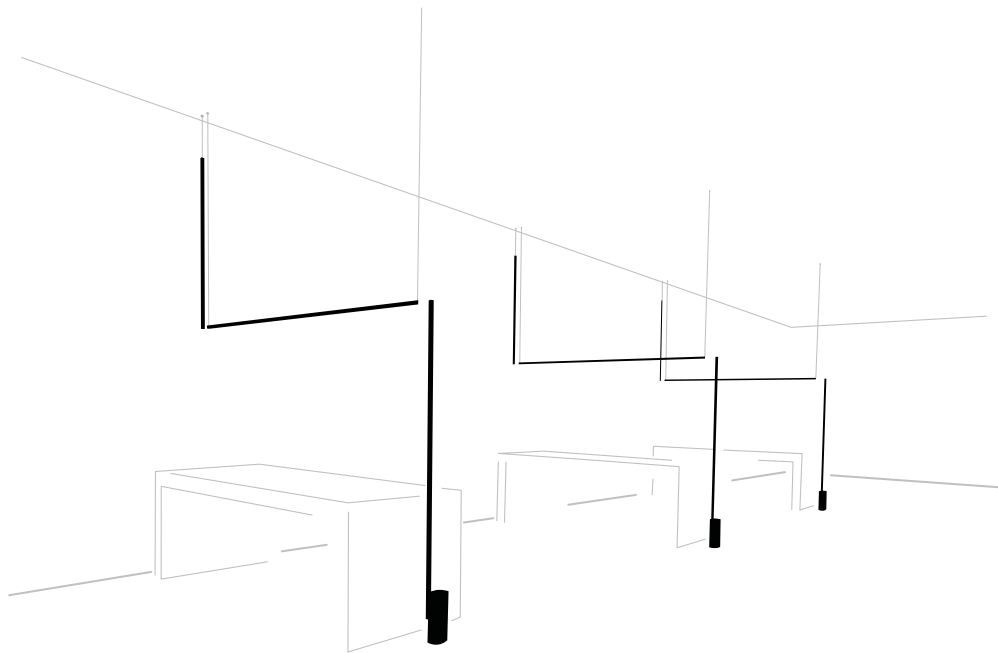

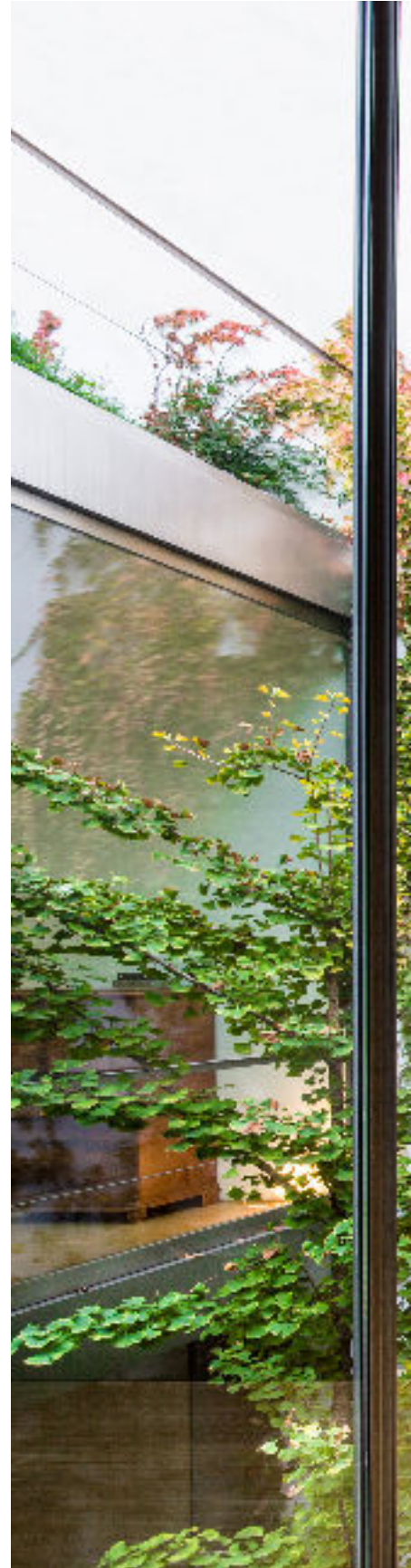
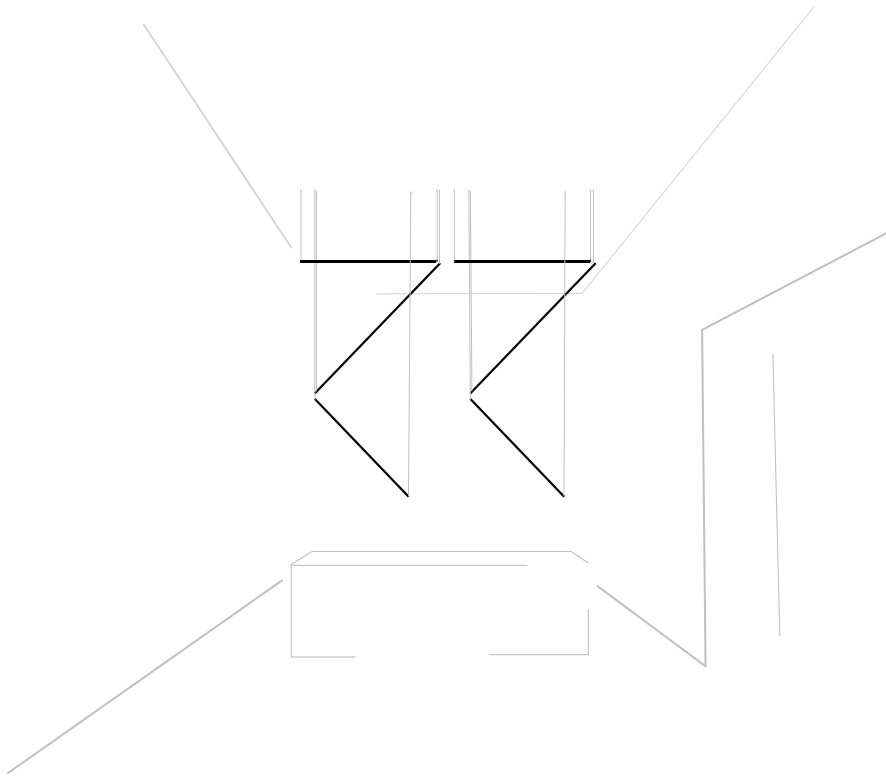



GET THE CATALOGUE AT HOME





“The professionals see the space differently from others. Sticks become their **Lighting Toolkit** to create whatever they think is correct because they know the space they are working on”.

Arik Levy

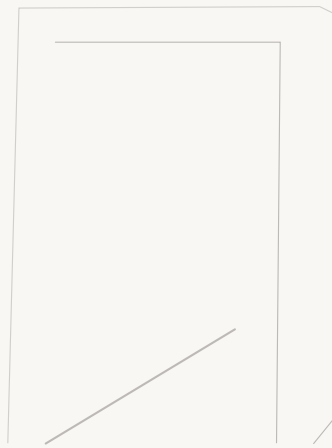
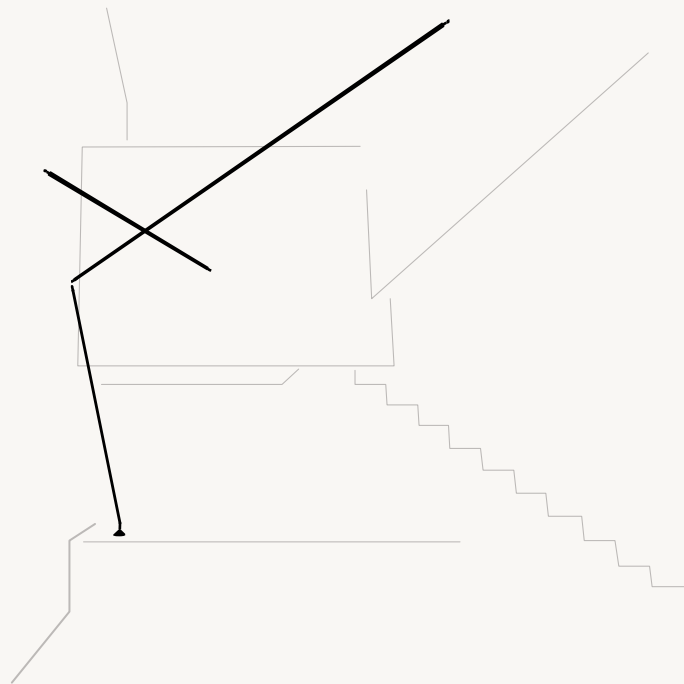
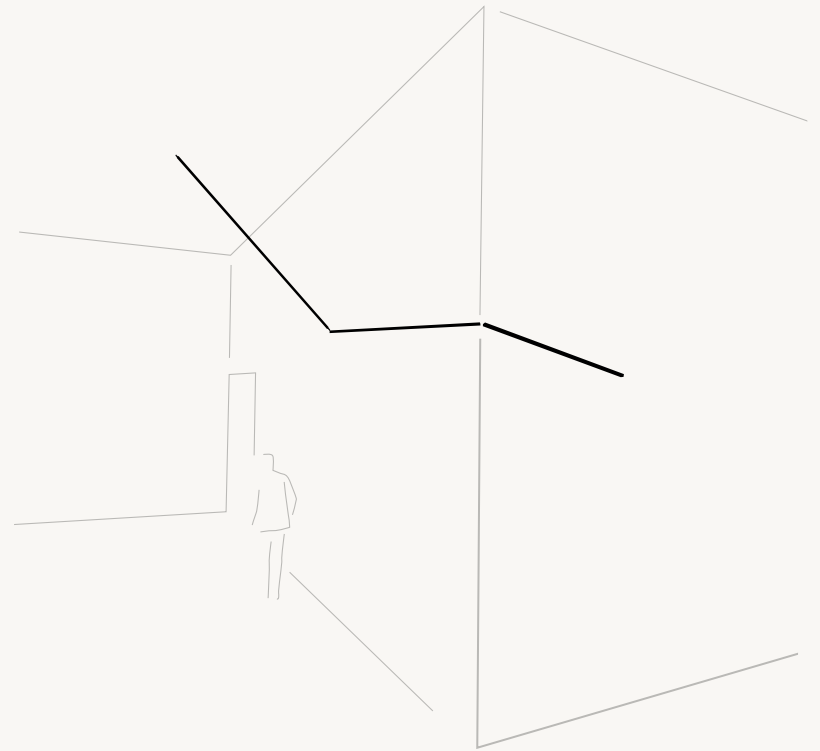

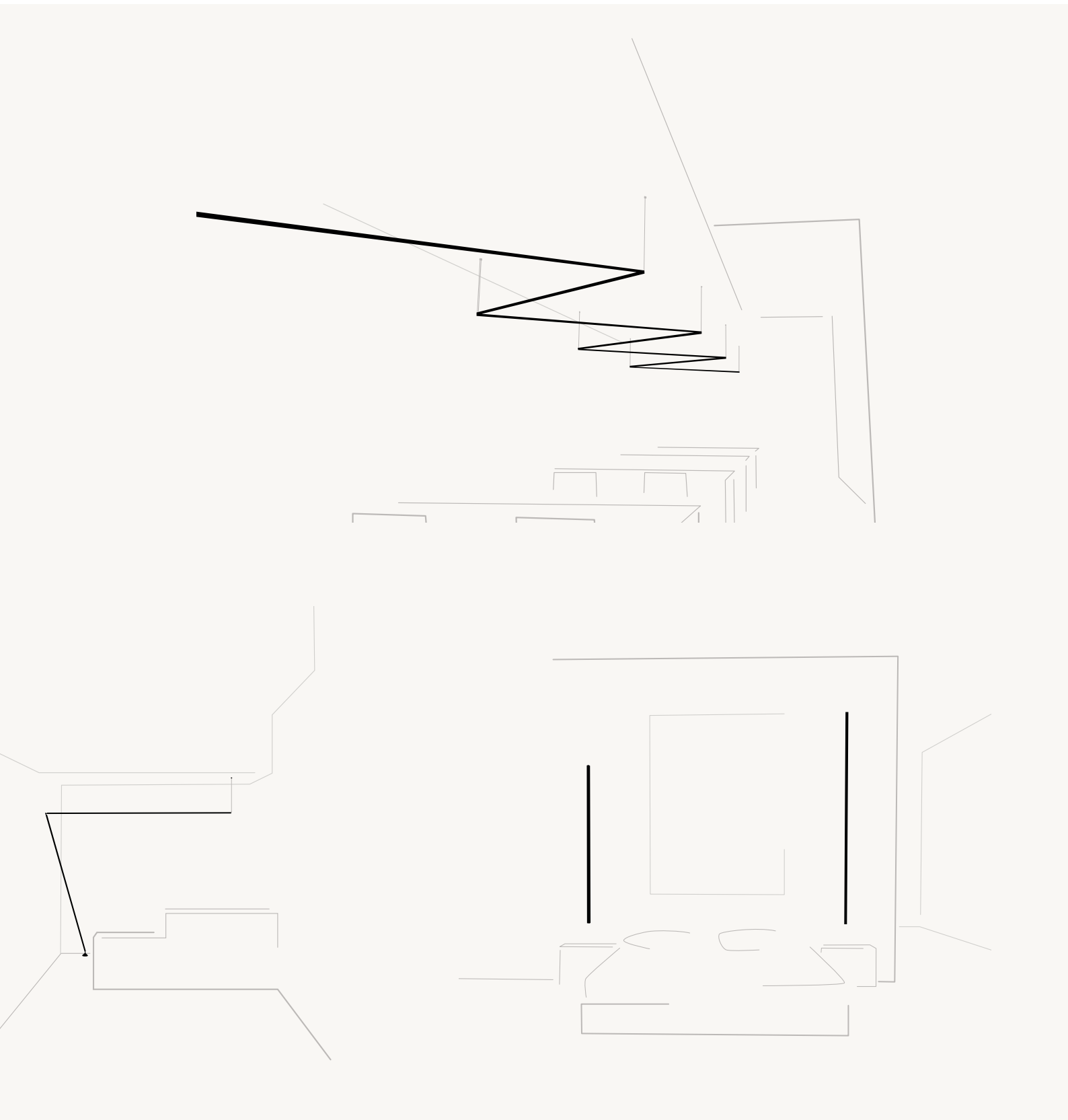





GET THE CATALOGUE AT HOME

One solution for every space

You can create your own layout adding connectable sticks or stand-alone model to your composition.

● 11 Black (NCS S 8500-N)

Sticks: Aluminum.
Diffuser: Polycarbonate.

LED 2700 K / 4000 K. CRI>90

Dimming:
Floor base & plug: Push.
Surface canopy,
Built-in: 1-10V.

Ref. 7338, 7339 and 7348
Dimming: Push.

Personalization options available

- Configuration layout at vibia.com
 - LED 3000 K
 - Dimming: DALI, Casambi.
Surface canopy, Built-in.
 - Extra cable length: Pendant sticks
- Request more information.

Stand-alone
Floor

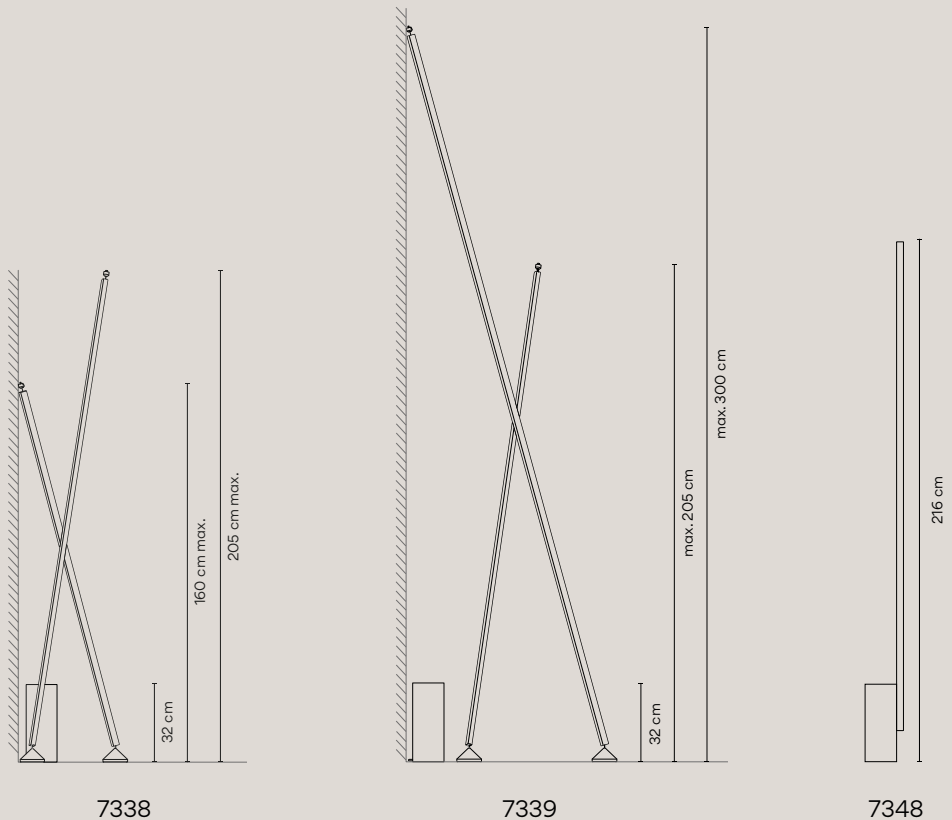

Connecting space application

Custom configurations include ceiling-to-ceiling, wall-to-wall, floor-to-wall, wall-to-ceiling, or suspended from the ceiling into open space. Through their physical form and the light they cast, they create and disrupt architectural planes.

Connectable

The Sticks collection has three sizes: 1.5 m, 2 m, or 3 m, and they can be connected one to each other to a total maximum length of 6.5 meters per electrical connection.

1.5 m

2 m

3 m

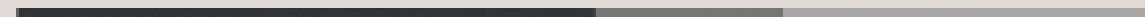

Sticks are connected one to each other with a 15 cm length cord.



Each stick rotates on its own axis, allowing light to be directed precisely where needed.

Floor
Floor-to-Wall
Stand-alone



Ceiling / Wall
Ceiling-to-Ceiling
Wall-to-Wall
Wall-to-Wall (corner)
Wall-to-Ceiling



Pendants
Wall-to-Pendant
Ceiling-to-Pendant
Vertical

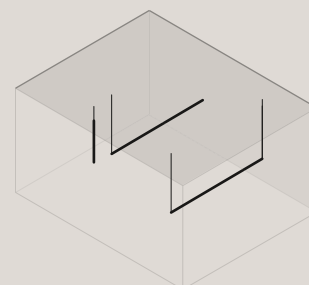
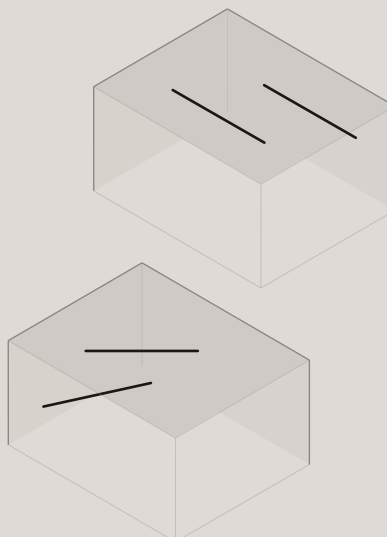
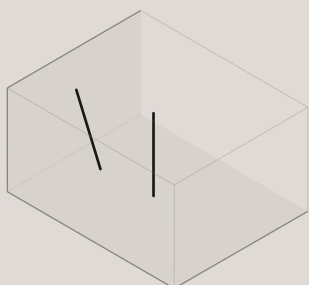



Create your own composition easy and quick at vibia.com selecting the option that best fits your needs.

A

Choose among pre-designed layouts based in multiple applications and spaces.

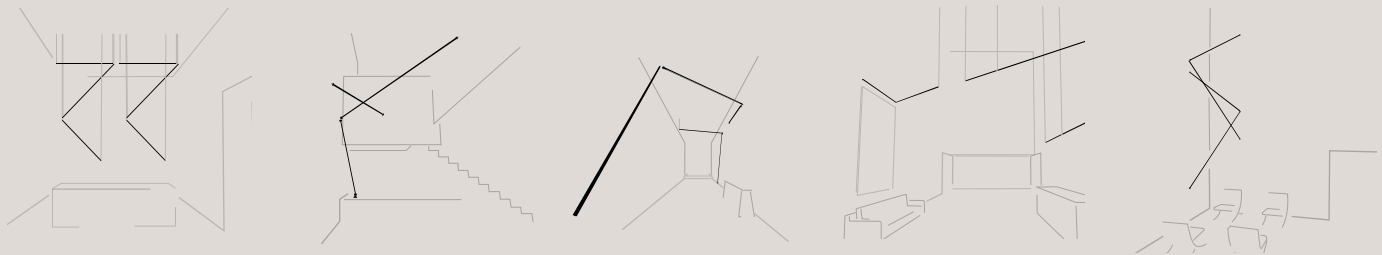

B

Adjust a pre-designed layout to your project by modifying:

- + Length of the sticks.
- + Position of each stick in the space.
- + Color temperature and dimming.
- + Installation type.

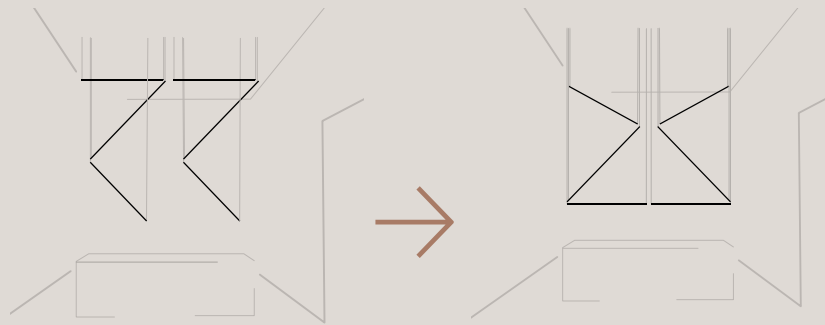

C

Create your connectable Sticks configuration from scratch in three easy steps, without sketches.

1

Choose the location for your electrical connection point



2

Add connectable Sticks up to 6.5 meters



3

Configure

- + Color temperature
- + Dimming control
- + Installation type
- + Pendant height



Top

Design by Ramos & Bassols.

Soft, spherical shapes and a warm luminescence characterize the Top collection. Its glowing epicenter is encircled by a larger ring, lending the look of framing the light within its pure geometry.



GET THE CATALOGUE AT HOME





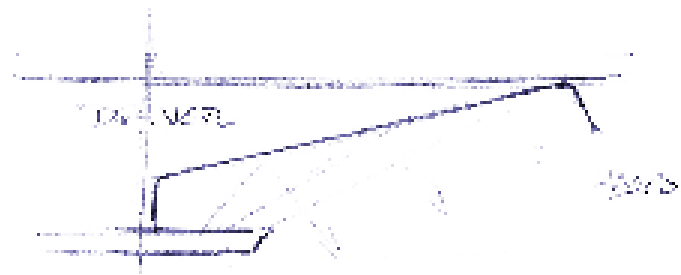
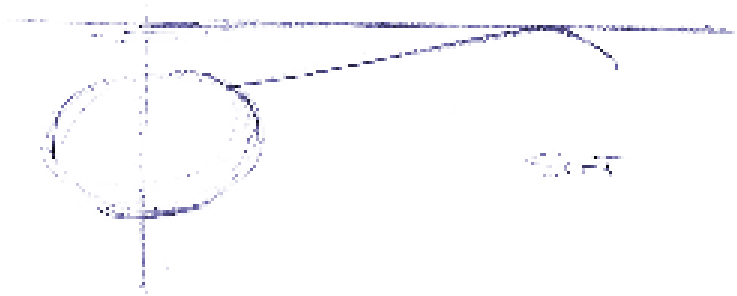
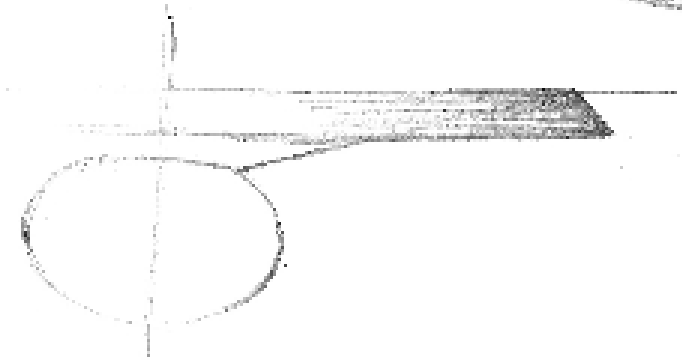
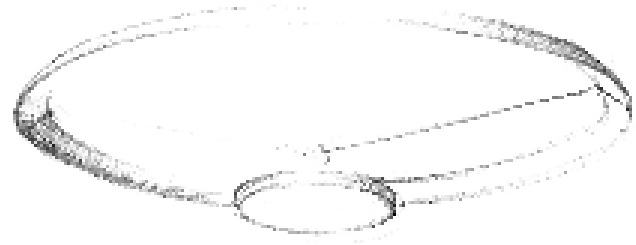
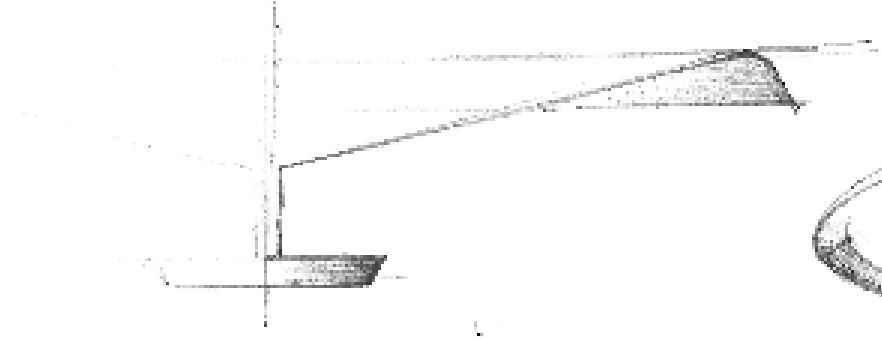
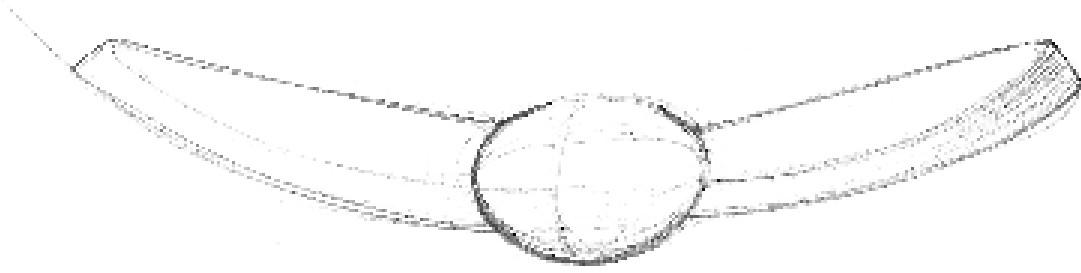







GET THE CATALOGUE AT HOME





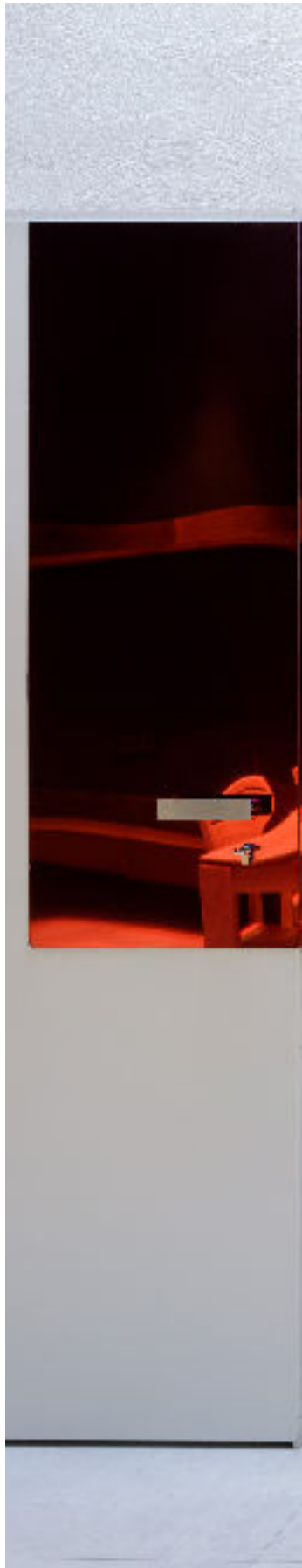





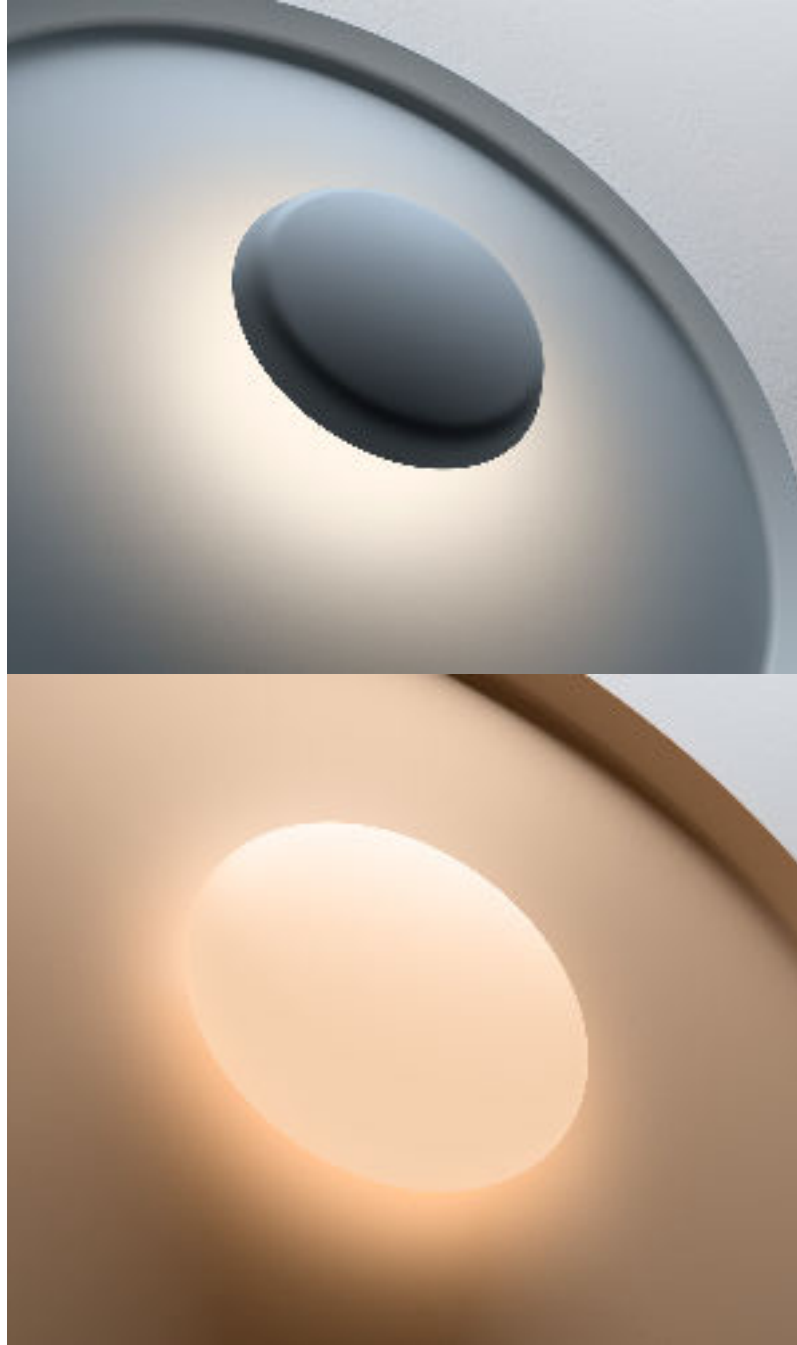







A modern reimagining of the timeless rosette motif, the Top ceiling and wall lights are distilled to its essence. A pair of simple circles creates a focal point of LED-powered light overhead that recalls a bullseye pulsing with a soft glow. Its small, illuminated sphere reflects light back towards the larger one, generating a halo effect of even, indirect light and a soothing ambiance. The ceiling and wall lights are crafted of aluminum and available in mini, small, medium, and large sizes, the latter fitted with a glass diffuser that emits general, direct light.

-  10 White (NCS S 0300-N)
-  36 Soft Pink (NCS S 1010-Y50R)
-  40 Blue L1 (NCS S 3010-B)
-  47 Green L1 (NCS S 4005-G80Y)

Body: Aluminum.

Ref. 1170.

Diffuser: Triplex Opal Glass.

LED 2700 K. CRI>90

Ref. 1155

Dimming: 1-10V, Push.

Ref. 1160, 1170

Dimming: 1-10V, DALI, Push.

Personalization options available

- LED 4000 K
 - Ref. 1155, 1160, 1170. Dimming: Casambi
- Request more information.

1170

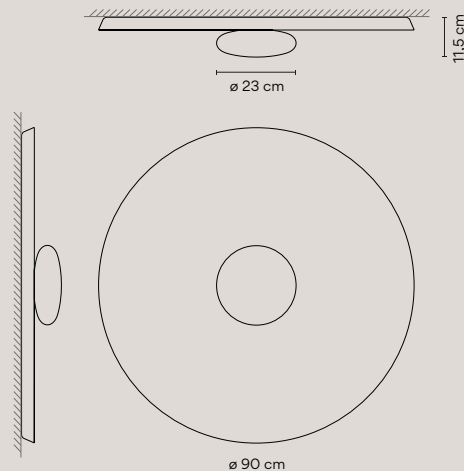

1160

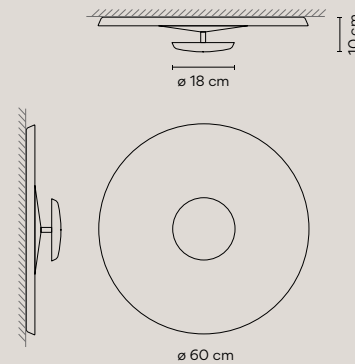

1155

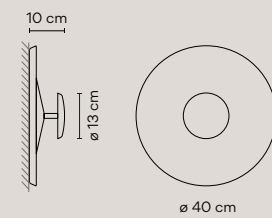

1154

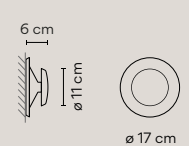

GET THE CATALOGUE AT HOME

Flat

Design by Ichiro Iwasaki.

Floor



5945 p. 19



5950 p. 19

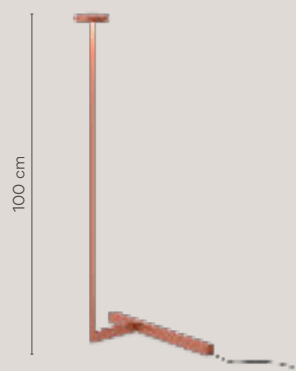

5955 p. 19





5957 p. 19

5945
2 x LED PLATE 7W 400mA.
LED 2700 K. CRI >90. 2400 lm. 171,4 lm/W.
Driver Constant Voltage 24V. 100-240V. 50/60Hz.
Dimming: Push.

Personalization options available
- LED 4000 K.
Request more information.

Shade: Aliminum.
Diffuser: Polycarbonate.
Structures: Steel.
Net Weight 15,85 Kg.

5945 13 /15 Grey L1 (NCS S 1000-N) 
5945 47 /15 Green L1 (NCS S 4005-G80Y) 

LED  IP20  CE  Dimmer  A+ 

5950
1 x LED PLATE 7W 400mA.
LED 2700 K. CRI >90. 1200 lm. 171,4 lm/W.
Driver Constant Voltage 24V. 100-240V. 50/60Hz.
Dimming: Push.

Personalization options available
- LED 4000 K.
Request more information.

Shade: Aliminum.
Diffuser: Polycarbonate.
Structures: Steel.
Net Weight 12,71 Kg.



5950 10 /15 White (NCS S 0300-N) 

LED  IP20  CE  Dimmer  A+ 

5955
1 x LED PLATE 7W 400mA.
LED 2700 K. CRI > 90. 1200 lm. 171,4 lm/W.
Driver Constant Voltage 24V. 100-240V. 50/60Hz.
Dimming: Push.

Personalization options available
- LED 4000 K.
Request more information.

Shade: Aliminum.
Diffuser: Polycarbonate.
Structures: Steel.
Net Weight 3,50 Kg.



5955 11 /15 Black (NCS S 8500-N) 
5955 37 /15 Terra Red (NCS S 4040-Y70R) 
5955 47 /15 Green L1 (NCS S 4005-G80Y) 

LED  IP20  CE  Dimmer  A+ 

5957
1 x LED PLATE 7W 400mA.
LED 2700 K. CRI >90. 1200 lm. 171,4 lm/W.
Driver Constant Voltage 24V. 100-240V. 50/60Hz.
Dimming: Push.

Personalization options available
- LED 4000 K.
Request more information.

Shade: Aliminum.
Diffuser: Polycarbonate.
Structures: Steel.
Net Weight 4,46 Kg.

5957 13 /15 Grey L1 (NCS S 1000-N) 
5957 47 /15 Green L1 (NCS S 4005-G80Y) 

LED  IP20  CE  Dimmer  A+ 

Pendants

* Upper side of the disc available in:
Grey L1, Terra Red y Green L1.

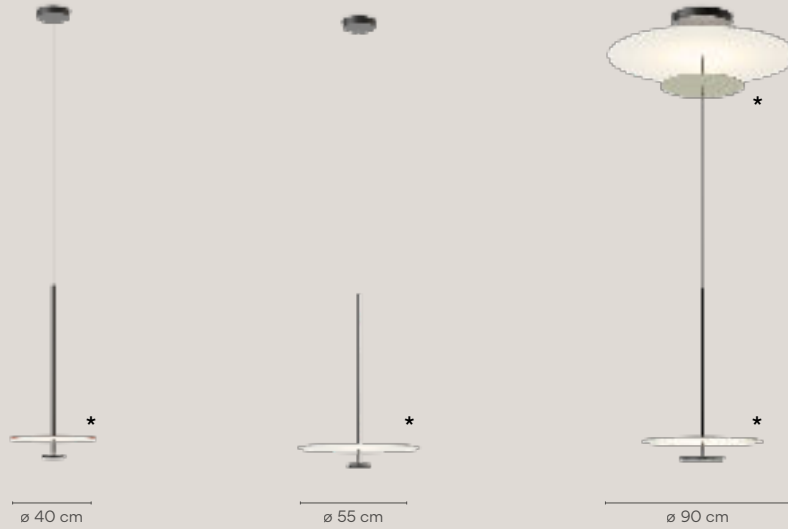

5935 p. 29

5940 p. 29

5930 p. 29

5930

3 x LED PLATE 25 W 700mA.
LED 2700 K. CRI >90. 10440 lm. 139,20 lm/W.
Driver Constant Current 700 mA. 110-240V. 50/60Hz.
Dimming: DALI, 1-10V, Push.

Personalization options available

- LED 4000 K.
 - Dimming: Casambi.
 - Extra cable length.
- Request more information.

Shade: Aliminum.
Diffuser: Polycarbonate.
Structures: Steel.
Cnopy: Aluminum.
Net Weight 21,16 Kg.

5930 13 /1A Grey L1 (NCS S 1000-N)

5930 37 /1A Terra Red (NCS S 4040-Y70R)

5930 47 /1A Green L1 (NCS S 4005-G80Y)



5935

1 x LED PLATE 13,5 W 700 mA.
LED 2700 K. CRI >90. 1740 lm. 128,88 lm/W.
Driver Constant current 700 mA. 110-240V. 50/60Hz.
Dimming: DALI, 1-10V, Push.

Personalization options available

- LED 4000 K.
 - Extra cable length.
- Request more information.

Shade: Aliminum.
Diffuser: Polycarbonate.
Structures: Steel.
Cnopy: Aluminum.
Net Weight 2,71 Kg.

5935 13 /1A Grey L1 (NCS S 1000-N)

5935 37 /1A Terra Red (NCS S 4040-Y70R)

5935 47 /1A Green L1 (NCS S 4005-G80Y)



5940

1 x LED PLATE 13,5 W 700 mA.
LED 2700 K. CRI >90. 1740 lm. 128,88 lm/W.
Driver Constant current 700 mA.
110-240V. 50/60Hz.
Dimming: DALI, 1-10V, Push.

Personalization options available

- LED 4000 K.
 - Extra cable length.
- Request more information.

Shade: Aliminum.
Diffuser: Polycarbonate.
Structures: Steel.
Cnopy: Aluminum.
Net Weight 7,33 Kg.

5940 13 /1A Grey L1 (NCS S 1000-N)

5940 37 /1A Terra Red (NCS S 4040-Y70R)

5940 47 /1A Green L1 (NCS S 4005-G80Y)



Table

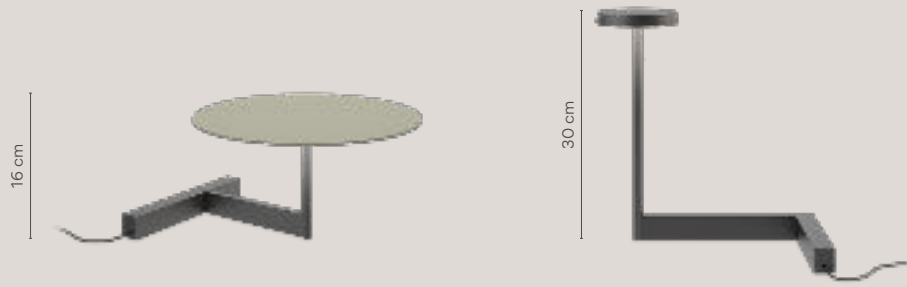

5965 p. 33

5970 p. 33

5965
 1 x LED PLATE 7W 400mA.
 LED 2700 K. CRI >90. 1200 lm. 171,4 lm/W.
 Driver Constant Voltage 24V. 100-240V. 50/60Hz.
 Dimming: Push.

Personalization options available
 - LED 4000 K.
 Request more information.

Shade: Aliminum.
 Diffuser: Polycarbonate.
 Structures: Steel.
 Net Weight 3,11 Kg.

- 5965 13 /15 Grey L1 (NCS S 1000-N) ●
- 5965 47 /15 Green L1 (NCS S 4005-G80Y) ●

LED IP20 CE Dimmer A+

5970
 1 x LED PLATE 7W 400mA.
 LED 2700 K. CRI >90. 1200 lm. 171,4 lm/W.
 Driver Constant Voltage 24V.
 100-240V. 50/60Hz.
 Dimming: Push.

Personalization options available
 - LED 4000 K.
 Request more information.

Shade: Aliminum.
 Diffuser: Polycarbonate.
 Structures: Steel.
 Net Weight 1,86 Kg.

- 5970 11 /15 Black (NCS S 8500-N) ●
- 5970 37 /15 Terra Red (NCS S 4040-Y70R) ●
- 5970 47 /15 Green L1 (NCS S 4005-G80Y) ●

LED IP20 CE Dimmer A+

Ceiling



ø 40 cm

5920 p. 42

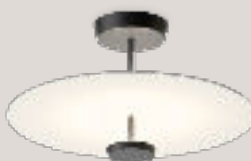

ø 55 cm

5915 p. 42



ø 90 cm

5926 p. 42

5915

2 x LED PLATE 13,5 W 700mA.
LED 2700 K. CRI >90. 3480 lm. 128,88 lm/W.
Driver Constant current 700 mA. 110-240V. 50/60Hz.
Dimming: DALI, 1-10V, Push.

Personalization options available
- LED 4000 K.
Request more information.

Shade: Aliminum.
Diffuser: Polycarbonate.
Structures: Steel.
Canopy: Aluminum.
Net Weight 4,73 Kg.

5915 10 /1A White (NCS S 0300-N)

LED  IP20  CE  Dimmer  A+ 

5920

1 x LED PLATE 13,5 W 700mA.
LED 2700 K. CRI >90. 1740 lm. 128,88 lm/W.
Driver Constant current 700 mA.
110-240V. 50/60Hz.
Dimming: DALI, 1-10V, Push.

Personalization options available
- LED 4000 K.
Request more information.

Shade: Aliminum.
Diffuser: Polycarbonate.
Structures: Steel.
Canopy: Aluminum.
Net Weight 1,91 Kg.

5920 10 /1A White (NCS S 0300-N)

5920 13 /1A Grey L1 (NCS S 1000-N)

5920 47 /1A Green L1 (NCS S 4005-G80Y)

LED  IP20  CE  Dimmer  A+ 

5926

2 x LED PLATE 25 W 700mA.
LED 2700 K. CRI >90. 6960 lm. 139,20 lm/W.
Driver Constant Current 700 mA.
110-240V. 50/60Hz.
Dimming: DALI, 1-10V, Push

Personalization options available
- LED 4000 K.
Request more information.

Shade: Aliminum.
Diffuser: Polycarbonate.
Structures: Steel.
Canopy: Aluminum.
Net Weight 10,08 Kg.

5926 10 /1A White (NCS S 0300-N)

LED  IP20  CE  Dimmer  A+ 

Ceiling



101 x 88 cm

5905 p. 42



106 x 90 cm

5910 p. 42

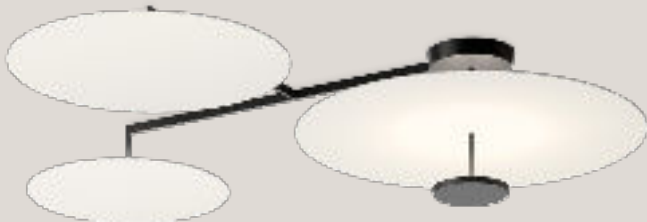

178 x 149 cm

5922 p. 42



186 x 149 cm

5924 p. 42

5905

4 x LED PLATE 13,5 W 700mA.
LED 2700 K. CRI >90. 6960 lm. 128,88 lm/W.
Driver Constant current 700 mA. 110-240V. 50/60Hz.
Dimming: DALI, 1-10V, Push.

Personalization options available

- LED 4000 K.
 Request more information.

Shade: Aliminum.
 Diffuser: Polycarbonate.
 Structures: Steel.
 Canopy: Aluminum.
 Net Weight 15,38 Kg.

5905 10 /1A White (NCS S 0300-N) 

5905 71 /1A White, Green L1, Grey L1
 (NCS S 0300-N, NCS S 4005-G80Y, NCS S 1000-N) 

5910

3 x LED PLATE 13,5 W 700mA.
LED 2700 K. CRI >90. 5220 lm. 128,88 lm/W.
Driver Constant current 700 mA. 110-240V. 50/60Hz.
Dimming: DALI, 1-10V, Push.

Personalization options available





- LED 4000 K.
 Request more information.

Shade: Aliminum.
 Diffuser: Polycarbonate.
 Structures: Steel.
 Canopy: Aluminum.
 Net Weight 9,10 Kg.

5910 10 /1A White (NCS S 0300-N) 

5910 72 /1A White, Green L1 (NCS S 0300-N, NCS S 4005-G80Y) 

5910 73 /1A White, Grey L1 (NCS S 0300-N, NCS S 1000-N) 

5922

4 x LED PLATE 25 W 700mA.
LED 2700 K. CRI >90. 13920 lm. 139,20 lm/W.
Driver Constant current 700 mA. 110-240V. 50/60Hz.
Dimming: DALI, 1-10V, Push.

Personalization options available

- LED 4000 K.
 - Dimming: Casambi.
 Request more information.

Shade: Aliminum.
 Diffuser: Polycarbonate.
 Structures: Steel.
 Canopy: Aluminum.
 Net Weight 19,98 Kg.

5922 10 /1A White (NCS S 0300-N) 

5922 71 /1A White, Green L1, Grey L1
 (NCS S 0300-N, NCS S 4005-G80Y, NCS S 1000-N) 

5924

3 x LED PLATE 25 W 700mA.
LED 2700 K. CRI >90. 10440 lm. 139,20 lm/W.
Driver Constant Current 700 mA. 110-240V. 50/60Hz.
Dimming: DALI, 1-10V, Push.

Personalization options available

- LED 4000 K.
 - Dimming: Casambi.
 Request more information.

Shade: Aliminum.
 Diffuser: Polycarbonate.
 Structures: Steel.
 Canopy: Aluminum.
 Net Weight 20,80 Kg.

5924 10 /1A White (NCS S 0300-N) 

5924 72 /1A White, Green L1 (NCS S 0300-N, NCS S 4005-G80Y) 

5924 73 /1A White, Grey L1 (NCS S 0300-N, NCS S 1000-N) 

    

Sticks

Design by Arik Levy.

Lighting Toolkit

Wall-Wall / Ceiling-Ceiling

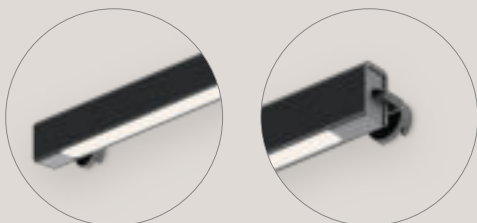

Stick 152 cm
7300 p.71

Stick 201 cm
7303 p.71

Stick 300 cm
7306 p.71

Wall-Wall (corner) / Wall-Ceiling

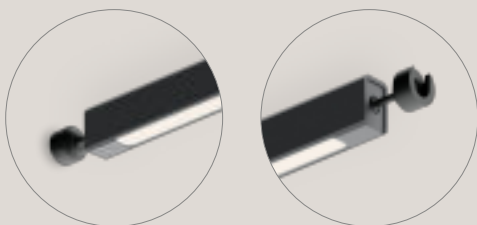

Stick 158 cm
7330 p.71

Stick 207 cm
7333 p.71

Stick 306 cm
7336 p.71

Wall-Pendant

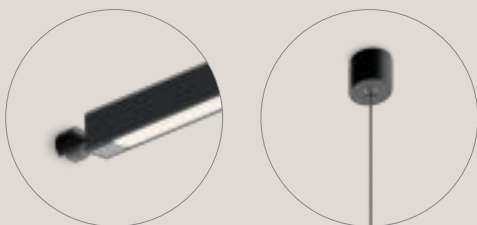

Stick 153 cm
7310 p.71

Stick 204 cm
7313 p.71

Stick 303 cm
7316 p.71

Pendant-Pendant

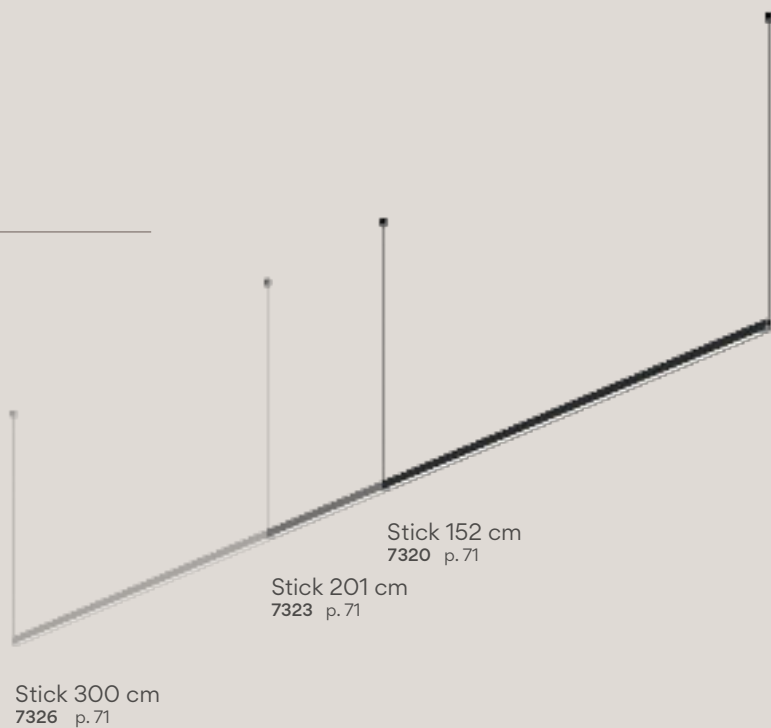
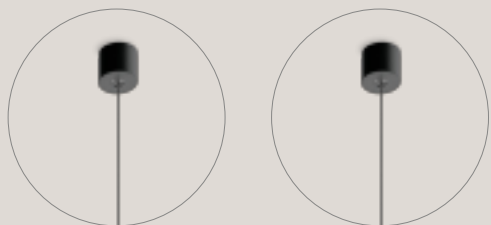

Pendant

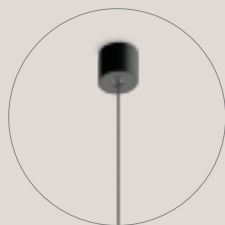

Floor-Wall

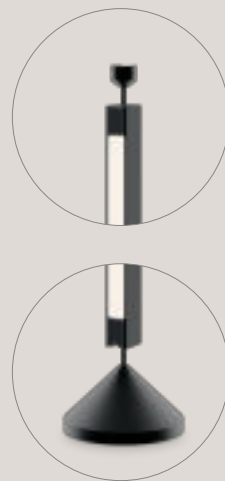

Wall-Wall / Ceiling-Ceiling
 Wall-Wall (corner) / Wall-Ceiling
 Wall-Pendant
 Ceiling-Pendant
 Pendant-Pendant
 Pendant

Sticks 1,5 m.

7300 7310 7320 7330 7350

1 x LED STRIP 26,4 W 24V.

/1 M 2700 K. CRI >90. 3260 lm. 123 lm/W.

/4 M 4000 K. CRI >90. 3561 lm. 134 lm/W.

Net Weight 0,9 Kg.

Sticks 2 m.

7303 7313 7323 7333 7353

1 x LED STRIP 35,2 W 24V.

/1 M 2700 K. CRI >90. 4346 lm. 123 lm/W.

/4 M 4000 K. CRI >90. 4748 lm. 134 lm/W.

Net Weight 1,2 Kg.

Sticks 3 m.

7306 7316 7326 7336 7356

1 x LED STRIP 52,8 W 24V.

/1 M 2700 K. CRI >90. 6519 lm. 123 lm/W.

/4 M 4000 K. CRI >90. 7122 lm. 134 lm/W.

Net Weight 1,8 Kg.

Sticks: Aluminum.

Diffuser: Polycarbonate.

Driver and Dimming depends on selected installation accessory (see page 99).

Suspension cables up to 3m. for (Wall - Pendant) and (Pendant-Pendant).

Personalization options available

- LED 3000 K.

- Extra cable length for (Wall-Pendant) and (Pendant - Pendant).

Request more information.

11 /1 M Black (NCS S 8500-N)

11 /4 M Black (NCS S 8500-N)







Floor-Wall

Sticks 1,5 m.

7340

1 x LED STRIP 26,4 W 24V.

/1 M 2700 K. CRI >90. 3260 lm. 123 lm/W.

/4 M 4000 K. CRI >90. 3561 lm. 134 lm/W.

Net Weight 1,5 Kg.

Sticks 2 m.

7343

1 x LED STRIP 35,2 W 24V.

/1 M 2700 K. CRI >90. 4346 lm. 123 lm/W.

/4 M 4000 K. CRI >90. 4748 lm. 134 lm/W.

Net Weight 1,8 Kg.

Sticks 3 m.

7346

1 x LED STRIP 52,8 W 24V.

/1 M 2700 K. CRI >90. 6519 lm. 123 lm/W.

/4 M 4000 K. CRI >90. 7122 lm. 134 lm/W.

Net Weight 2,4 Kg

Sticks: Aluminum.

Diffuser: Polycarbonate.

Driver and Dimming depends on selected installation accessory (see page 99).**Personalization options available**



- LED 3000 K.

Request more information.

11 /1 M Black (NCS S 8500-N)

11 /4 M Black (NCS S 8500-N)

Installation types



Floor base & plug

ø 13x32 cm



Surface canopy

40x4x10 cm



Built-in disc S

ø 12x6 cm

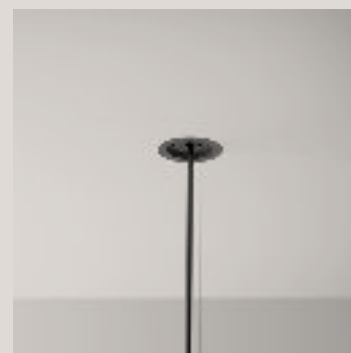

Remote driver Built-in Micro

ø 4x7 cm

Floor base & plug

ACST000001 ACST000002

Driver Constant Voltage 24V. 200-240V. 50/60Hz.

Dimming: Push.

Body: Steel.

Net Weight 7 Kg.

11 Black (NCS S 8500-N)

**Surface canopy**

ACST000003 ACST000004

Driver Constant Voltage 24V. 90-305V. 50/60Hz.

Dimming: 1-10V.

Personalization options available

- Dimming: DALI, Casambi.

Request more information.

Body: Steel.

Net Weight 2,5

11 Black (NCS S 8500-N)

**Built-in disc S**

ACST000005 ACST000006

Driver Constant Voltage 24V. 90-305V. 50/60Hz.

Dimming: 1-10V.

Personalization options available

- Dimming: DALI, Casambi.

Request more information.

Body: Steel.

Net Weight 1,5

11 Black (NCS S 8500-N)

**Remote driver Built-in Micro**

ACST000007 ACST000008

Driver Constant Voltage 24V. 90-305V. 50/60Hz.

Dimming: 1-10V.

Personalization options available

- Dimming: DALI, Casambi.

Request more information.

Body: Aluminum.

Net Weight 1,5

11 Black (NCS S 8500-N)



Stand-alone

Floor

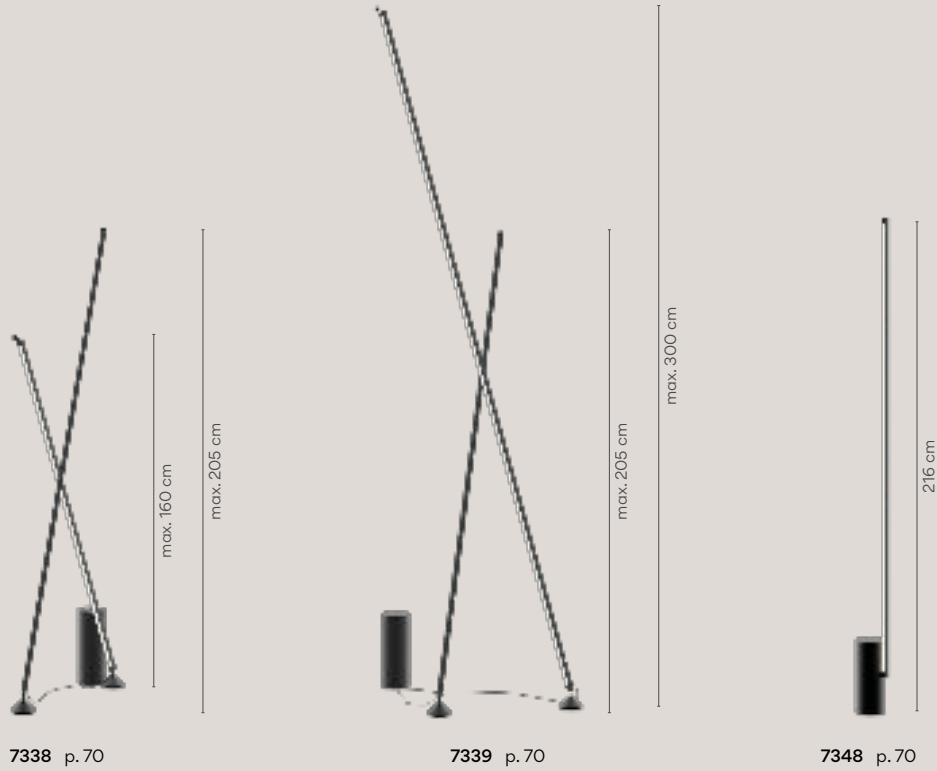

7338
 1 x LED STRIP 26,4 W 24V.
 1 x LED STRIP 35,2 W 24V.
 /15 2700 K. CRI >90. 7606 lm. 123 lm/W.
 /45 4000 K. CRI >90. 8309 lm. 134 lm/W.
 Driver Constant Voltage 24V. 200-240V. 50/60Hz
 Dimming: Push.
Personalization options available
 - LED 3000 K.
 Request more information.

Sticks: Aluminum.
 Diffuser: Polycarbonate.
 Net Weight 9,1 Kg.

7338 11 /15 Black (NCS S 8500-N) ●
 7338 11 /45 Black (NCS S 8500-N) ●

LED IP20 CE Dimmer A+

7339
 1 x LED STRIP 35,2 W 24V.
 1 x LED STRIP 52,8 W 24V.
 /15 2700 K. CRI >90. 10865 lm. 123 lm/W.
 /45 4000 K. CRI >90. 11870 lm. 134 lm/W.
 Driver Constant Voltage 24V. 200-240V. 50/60Hz
 Dimming: Push.
Personalization options available
 - LED 3000 K.
 Request more information.

Sticks: Aluminum.
 Diffuser: Polycarbonate.
 Net Weight 10 Kg.

7339 11 /15 Black (NCS S 8500-N) ●
 7339 11 /45 Black (NCS S 8500-N) ●

LED IP20 CE Dimmer A+

7348
 1 x LED STRIP 35,2 W 24V.
 /15 2700 K. CRI >90. 4346 lm. 123 lm/W.
 /45 4000 K. CRI >90. 4748 lm. 134 lm/W.
 Driver Constant Voltage 24V. 200-240V. 50/60Hz
 Dimming: Push.
Personalization options available
 - LED 3000 K.
 Request more information.

Sticks: Aluminum.
 Diffuser: Polycarbonate.
 Net Weight 8,2 Kg.

7348 11 /15 Black (NCS S 8500-N) ●
 7348 11 /45 Black (NCS S 8500-N) ●

LED IP20 CE Dimmer A+

Top

Design by Ramos & Bassols.

Ceiling Wall

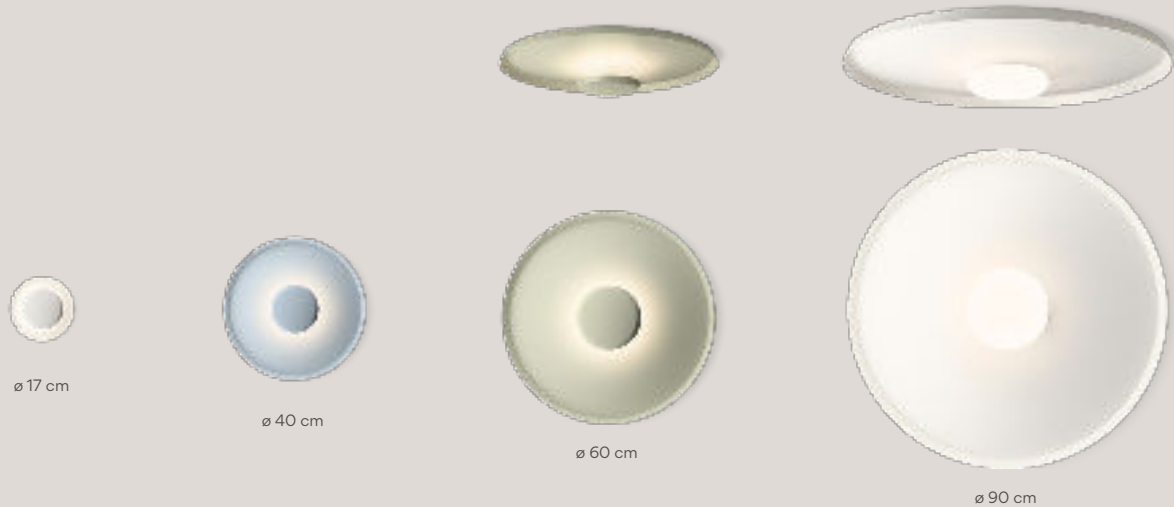

1154 p. 89

1155 p. 89

1160 p. 89

1170 p. 89

1154

1 x LED PLATE 5,5W 150mA.
LED 2700 K. CRI >90. 550 lm. 100 lm/W.
Driver Constant current 150 mA. 100-240V. 50/60Hz

Personalization options available

- LED 4000 K.
Request more information.

Body: Aluminum.
Net Weight 0,5 Kg.

1154 10 /10 White (NCS S 0300-N)
1154 36 /10 Soft pink (NCS S 1010-Y50R)
1154 40 /10 Blue L1 (NCS S 3010-B)
1154 47 /10 Green L1 (NCS S 4005-G80Y)

LED IP20 CE A+

1155

1 x LED PLATE 18,3W 500mA.
LED 2700 K. CRI >90. 2050 lm. 112 lm/W.
Driver Constant current 500 mA. 220-240V. 50/60Hz.
Dimming: 1-10V, Push.

Personalization options available

- LED 4000 K.
- Dimming: Casambi.
Request more information.

Body: Aluminum.
Net Weight 1,5 Kg.

1155 10 /1B White (NCS S 0300-N)
1155 36 /1B Soft pink (NCS S 1010-Y50R)
1155 40 /1B Blue L1 (NCS S 3010-B)
1155 47 /1B Green L1 (NCS S 4005-G80Y)

LED IP20 CE Dimmer A+

1160

1 x LED PLATE 26,4W 700mA.
LED 2700 K. CRI >90. 2880 lm. 109,10 lm/W.
Driver Constant current 700 mA. 110-240V. 50/60Hz.
Dimming: DALI, 1-10V, Push.

Personalization options available

- LED 4000 K.
- Dimming: Casambi.
Request more information.

Body: Aluminum.
Net Weight 2,5 Kg.

1160 10 /1A White (NCS S 0300-N)
1160 36 /1A Soft pink (NCS S 1010-Y50R)
1160 40 /1A Blue L1 (NCS S 3010-B)
1160 47 /1A Green L1 (NCS S 4005-G80Y)

LED IP20 CE Dimmer A+

1170

3 x LED 13,4W 700mA.
LED 2700 K. CRI >90. 3300 lm. 82,08 lm/W.
Driver Constant Current 700 mA. 220-240V. 50/60Hz.
Dimming: DALI, 1-10V, Push.

Personalization options available

- LED 4000 K.
- Dimming: Casambi.
Request more information.

Body: Aluminum.
Diffuser: Triplex Opal Glass.
Net Weight 5,3 Kg.

1170 10 /1A White (NCS S 0300-N)
1170 36 /1A Soft pink (NCS S 1010-Y50R)
1170 40 /1A Blue L1 (NCS S 3010-B)
1170 47 /1A Green L1 (NCS S 4005-G80Y)

LED IP20 CE Dimmer A+

ACKNOWLEDGEMENTS

Project name: DTI Group - Office
Architecture & Interior Design: VEVS Amsterdam
(Rob van Sprang - Martijn d'Herripon)
Photography: Mike Bink
(page 10, 11)

© Pawel Chu
(page 21)

Marià Castelló
@mcastello_arch
(page 37, 47, 81, 86)

© Fran Silvestre Arquitectos
(page 49)

Photography: Toshiyuki Yano
(page 55)

© Reinhart Julian
(page 52)

MR.P Studios
(page 51)

The content of this catalogue may be changed
or cancelled at the discretion of the VIBIA
management without prior notice.

Vibia Lighting, S.L.U.

Spain & Portugal T. +34 934 796 970
International T. +34 934 796 971
vibia@vibialighting.com
www.vibia.com

