



LIVING
COLLECTION
2020

marelli

Indice prodotti

PRODUCT LIST

marelli

Divani

SOFAS

Andy
PAGE 107 T.I. 196



Atacama
PAGE 95 T.I. 200



Clipper
PAGE 9 T.I. 210



Derek
PAGE 47 T.I. 216



Gary
PAGE 55 T.I. 226



Gordon
PAGE 177 T.I. 228



L-Sofa
PAGE 143 T.I. 244



Loft
PAGE 63 T.I. 300



Matheus
PAGE 117 T.I. 295



Moon
PAGE 35 T.I. 261



Liam
PAGE 21 T.I. 248



New York
PAGE 133 T.I. 263



Paris
PAGE 85 T.I. 267



William
PAGE 153 T.I. 278



Sedie e poltrone

CHAIRS AND ARMCHAIRS

Chia
T.I. 204



Joy
T.I. 240



Nicole
T.I. 266



Well
T.I. 277



Tavoli

DINING TABLE

Kyoto
PAGE 124 T.I. 241



Mike
PAGE 79 T.I. 258



Twig
PAGE 165 T.I. 275



Tavolini

COFFEE TABLE

Break
TI. 202



Clip
PAGE 8 TI. 353



Elle
TI. 216



Frame
TI. 218



Leaf
TI. 243



Dune
TI. 214



Mini
TI. 256



Tab
TI. 266



Thor
TI. 268



Tom
TI. 270



Twig
TI. 271



Divani letto

SOFA BEDS

Dream
TI. 285



Guest
TI. 289



Plus
TI. 293



Rem
TI. 297



Credenze

SIDEBOARDS

Kyoto
TI. 241



Living

COLLECTION 2020

marelli



Clipper

DESIGN
STEFANO GALLIZIOLI
2019

marelli

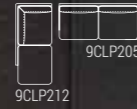

CLIPPER composition cm 312x212x90h
Fabric: cat. C art. San Diego col. 65
Base: OPM9 Classic bronze painted metal

Cushions:
2 x **9CU103 cm 40x40**
Fabric: cat. C art. San Diego col. 65
1 x **9CU106 cm 45x45**
Leather: cat. Lusso art. Brevia col. P-4202 Bruno

TAB coffee table
7TAB113 ø cm 90x36h
Base: OPM6 RAL 9017 traffic black painted metal
Upper top: OPP2 Marquinia black marble
Lower top: OPV13 Transparent grey glass

KYOTO coffee table
7KY101 ø cm 40x48h
Base: OPM3 brushed matt dark grey metal
Top: OPV9 Chrome back-painted bronze glass





CLIPPER composition cm 312x212x90h
Fabric: cat. C art. San Diego col. 65
Base: OPM9 Classic bronze painted metal

Cushions:
2 x **9CU103 cm 40x40**
Fabric: cat. C art. San Diego col. 65
1 x **9CU106 cm 45x45**
Leather: cat. Lusso art. Brevia col. P-4202 Bruno



DUNE coffee table
7DU103 cm 130x80x37h
Base: OPR15 moka matt stained oak + OPM15 antique gold brushed metal
Top: OPP13 Velvet brown marble



CLIPPER armchair
9CLX102 cm 70x80x91h
Leather: cat. Lusso art. Brevia col. P-4205 Creta
Base: OPR15 moka matt stained oak

DUNE coffee tables:
7DU101 ø cm 40x42h
7DU102 ø cm 40x52h
Base: OPR15 moka matt stained oak
Top: OPP13 Velvet brown marble

CLIPPER sofa
9CLP203 cm 264x95x90h
 Fabric: cat. C art. Pantera col. 25
 Base: OPR15 moka matt stained oak

Cushions:
 2 x **9CU106 cm 45x45**
 Fabric: cat. C art. Pantera col. 25
 2 x **9CU103 cm 40x40**
 Fabric: cat. H art. Rubelli Spritz col. 24 Reseda

CLIPPER armchairs
9CLX107 cm 70x76x75h
 Fabric: cat. E art. Dolomiti col. 136
 Base: OPM6 RAL 9017 traffic black painted metal

FRAME coffee table
7FR121 ø cm 100x28h
 Base: OPM6 RAL 9017 traffic black painted metal
 Top: OPP11 Grey Stone marble

CLIP coffee tables
7CL118 ø cm 40x50h
 OPM14 shiny black chrome metal
7CL133 ø cm 60x40h
 Base: OPM6 RAL 9017 traffic black painted metal
 Top: OPP12 Guatemala green marble



CLIPPER armchairs
9CLX107 cm 70x76x75h
 Fabric: cat. E art. Dolomiti col. 136
 Base: OPM6 RAL 9017 traffic black painted metal

ELLE coffee table
7EL107 cm 50x50x43h
 OPM6 RAL 9017 traffic black painted metal



FRAME coffee table
7FR121 ø cm 100x28h
 Base: OPM6 RAL 9017 traffic black painted metal
 Top: OPP11 Grey Stone marble

CLIP coffee table
7CL118 ø cm 40x50h
 OPM14 shiny black chrome metal





Liam

DESIGN
STUDIO MARELLI
2020

marelli

LIAM

9LI204 cm 240x100x84h sofa
 Fabric: cat. F art. Aime Misia col. M188 907 cacao
 Feet: version B, OPM15 antique gold brushed metal
9LI103 cm 100x100x40h ottoman
 Fabric: cat. E art. Burri col. 3
 Feet: version B, OPM15 antique gold brushed metal

Cushions:

2 x **9RL102 cm 45x45**
 Fabric: cat. E art. Burri col. 3
 1 x **9CU106 cm 45x45**
 Fabric: cat. F art. Misia Aime col. M188 420 cuivre

CLIP coffee tables

7CL117 ø cm 40x40h
7CL116 ø cm 60x27h
 OPM15 antique gold brushed metal

TAB coffee table

7TAB116 cm 90x90x36h
 Base: OPM9 classic bronze painted metal
 Lower top: OPV9 chrome back-painted bronze metal
 Upper top: OPP14 Amani bronze marble



KYOTO sideboard
7KY207 cm 220x50x71h
Structure: OPR15 moka matt stained oak
Base: OPM17 bronze metal
Top: OPP14 Amani bronze marble



CLIP coffee tables
7CL116 ø cm 60x27h
7CL117 ø cm 40x40h
7CL118 ø cm 40x50h
OPM15 antique gold brushed metal





LIAM composition cm 300x215x48h
 Fabric: cat. C art. San Diego col. 171
 Feet: version A, OPM9 classic bronze painted metal

Cushions:
 1 x **9CU106 cm 45x45**
 Leather: cat. Lusso art. Seta col. Militare
 2 x **9CU106 cm 45x45**
 Fabric: cat. C art. San Diego col. 171
 1 x **9CU106 cm 45x45**
 Leather: cat. Lusso art. Brevia col. P-4202 Bruno

DUNE coffee tables
7DU116 ø 125x37h
 Base: OPR15 moka matt stained oak
 + OPM15 antique gold brushed metal
 Top: OPV12 transparent bronze glass
7DU101 ø 40x42h
 Base: OPR15 moka matt stained oak
 Top: OPP14 Amani bronze marble





Details of **LIAM** composition
in fabric cat. C art. San Diego col. 171



LIAM sofa
9LI204 cm 240x100x84h
Leather: cat. Lusso art. Brevia col. P-4257 Antracite
Feet: version A, Classic bronze painted metal

Cushions:
9CU106 cm 45x45
Fabric: cat. H art. Rubelli Spritz col. 25 Lichene

KYOTO coffee table
7KY113 cm 80x80x38h
Base: OPM14 shiny black chrome metal
Top: Calacatta gold marble

DUNE coffee table
7DU108 ø cm 80x37h
Base: OPR15 moka matt stained oak + OPM14 shiny black chrome metal
Top: OPP7 Calacatta gold marble

CLIP side table
7CL118 ø 40x50h
OPM14 shiny black chrome metal





Detail of **LIAM** sofa with **CLIP** coffee table **7CL118** ø cm **40x50h** in OPM14 shiny black chrome metal

DUNE coffee table
7DU108 ø cm **80x37h**
Base: OPR15 moka matt stained oak + OPM14 shiny black chrome metal
Top: OPP7 Calacatta gold marble

CLIP side table
7CL118 ø **40x50h**
OPM14 shiny black chrome metal





Moon

DESIGN
STUDIO MARELLI
2019

marelli

**MOON****9MN204 cm 305x120x76h** sofa

Fabric: cat. G art. Orsetto 01/1

Base: OPM15 antique gold brushed metal

9MN102 ø 60x40h ottoman

Fabric: cat. G art. Orsetto 01/1

Base: OPM15 antique gold brushed metal

9MN102 ø cm 60x40h ottoman

Fabric: cat. H art. Casamance Némesia 4320.01 57

Base: OPM15 antique gold brushed metal

9MN101 cm 103x90x76h armchair

Fabric: cat. F art. Misia Aime col. M188 420 Cuivre

Base: OPM15 antique gold brushed metal

Cushions:

1 x **9CU103 cm 40x40**

Fabric: cat. H art. Casamance Némesia 4320.01 57

1 x **9CU103 cm 40x40**

Fabric: cat. F art. Misia Aime col. M188 420 Cuivre

CLIP coffee table**7CL126 ø cm 40x50h**

Base: OPM15 antique gold brushed metal

Top: OPP9 Black and Gold marble

TAB coffee table**7TAB124 ø cm 125x36h**

Base: OPM18 anodyc bronze painted metal

Upper top: OPV9 chrome back-painted matt bronze metal

Lower top: OPV9 chrome back-painted shiny bronze glass



MOON armchair
9MN101 cm 103x90x76h
 Fabric: cat. F art. Misia Aime col. M188 420 Cuivre
 Base: OPM15 antique gold brushed metal

TAB coffee table
7TAB124 ø cm 125x36h
 Base: OPM18 anodized bronze painted metal
 Upper top: OPV9 chrome back-painted matt bronze metal
 Lower top: OPV9 chrome back-painted shiny bronze glass



MOON
9MN204 cm 305x120x76h sofa
 Fabric: cat. G art. Orsetto 01/1
 Base: OPM15 antique gold brushed metal
9MN102 ø 60x40h ottoman
 Fabric: cat. G art. Orsetto 01/1
 Base: OPM15 antique gold brushed metal
9MN102 ø cm 60x40h ottoman
 Fabric: cat. H art. Casamance Nemesia 4320 01 57
 Base: OPM15 antique gold brushed metal

Cushions:
 1 x **9CU103 cm 40x40**
 Fabric: cat. H art. Casamance Nemesia 4320 01 57
 1 x **9CU103 cm 40x40**
 Fabric: cat. F art. Misia Aime col. M188 420 Cuivre

CLIP coffee table
7CL126 ø cm 40x50h
 Base: OPM15 antique gold brushed metal
 Top: OPP9 Black and Gold marble



MOON sofa
9MN202 cm 250x90x76h
Fabric: cat. H art. Sahco Kent col. 001
Base: OPM14 shiny black chrome metal

Cushion:
9CU103 cm 40x40
Fabric: cat. H art. Sahco Kent col. 002

MOON armchair
9MN101 cm 103x90x76h
Fabric: cat. H art. Sahco Kent col. 002
Base: OPM14 shiny black chrome metal

THOR side table
7TH104 cm 50x50x50h
OPP15 Covelano white marble

TWIG coffee table
7TG104 cm 120x70x35h
Base: OPM14 shiny black chrome metal
Top: OPP15 Covelano white marble

MOON sofa
9MN202 cm 250x90x76h
 Fabric: cat. H art. Sahco Kent col. 001
 Base: OPM14 shiny black chrome metal

Cushion:
9CU103 cm 40x40
 Fabric: cat. H art. Sahco Kent col. 002

MOON armchair
9MN101 cm 103x90x76h
 Fabric: cat. H art. Sahco Kent col. 002
 Base: OPM14 shiny black chrome metal

THOR side table
7TH104 cm 50x50x50h
 OPP15 Covelano white marble

TWIG coffee table
7TG104 cm 120x70x35h
 Base: OPM14 shiny black chrome metal
 Top: OPP15 Covelano white marble





MOON sofa
9MN202 cm 250x90x76h
 Fabric: cat. H art. Sahco Kent col. 001
 Base: OPM14 shiny black chrome metal

Cushion:
9CU103 cm 40x40
 Fabric: cat. H art. Sahco Kent col. 002

THOR side table
7TH104 cm 50x50x50h
 OPP15 Covelano white marble



TWIG coffee table
7TG104 cm 120x70x35h
 Base: OPM14 shiny black chrome metal
 Top: OPP15 Covelano white marble



Derek

DESIGN
STUDIO MARELLI
2019

marelli



DEREK sofa
9DK202 cm 188x70x77h
 Fabric: cat. C art. Pantera col. 25
 Base: OPR15 moka matt stained oak

1 x **9CU106 cm 45x45**
 Leather: cat. Lusso art. Brevia col. P-4202 Bruno

DEREK armchairs
9DK101 cm 75x70x77h
 Leather: cat. Lusso art. Seta col. Ebano (x1)
 Fabric: cat. H art. Sahco Kent col. 003 (x2)
 Base: OPR15 moka matt stained oak

DUNE coffee tables:
7DU101 ø cm 40x42h
7DU102 ø cm 40x52h
 Base: OPR15 moka matt stained oak
 Top: OPP13 Velvet brown marble

FRAME coffee table
7FR121 ø cm 100x28h
 Base: OPM15 antique gold brushed metal
 Top: OPP13 Velvet brown marble

CLIP coffee table
7CL117 ø cm 40x40h
 OPM15 antique gold brushed metal



DEREK armchair
9DK101 cm 75x70x77h
Leather: cat. Lusso art. Seta col. Ebanò
Base: OPR15 moka matt stained oak

DUNE coffee table
7DU101 ø cm 40x42h
Base: OPR15 moka matt stained oak
Top: OPP13 Velvet brown marble



DEREK armchairs
9DK101 cm 75x70x77h
Fabric: cat.
Base: OPR15 moka matt stained oak



CHIA armchairs
9CH1105 cm 58x53x77h
 Fabric: cat. C art. Koala col. 123
 Metal base: OPM15 antique gold brushed

DEREK sofa
9DK202 cm 188x70x77h
 Fabric:
 Base: OPR15 moka matt stained oak

1 x **9CU106 cm 45x45**
 Leather: cat. Lusso art. Brevia col. P-4202 Bruno

DEREK armchairs
9DK101 cm 75x70x77h
 Fabric: cat.
 Base: OPR15 moka matt stained oak

FRAME coffee table
7FR121 ø cm 100x28h
 Base: OPM15 antique gold brushed metal
 Top: OPP3 Emperador brown

DUNE coffee tables
7DU101 ø cm 40x42h
7DU102 ø cm 40x52h
 Base: OPR15 moka matt stained oak
 Top: OPP13 Velvet brown marble



Gary

DESIGN
STUDIO MARELLI
2019

marelli

- 1 - 9GY401
- 2 - 9GY504
- 3 - 9GY503

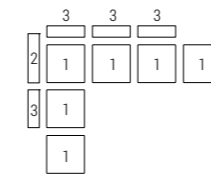

GARY composition cm 330x430x60h
 6 x cushions with piping **9GY103 cm 60x60**
 6 x cushions with piping **9GY102 cm 45x45**
 Fabric: cat. G art. Dominique Kieffer/Rubelli art. Velour
 Soleil col. 17189-013 Gris Perle

TWIG coffee tables
7TG101 ø cm 50x50h
7TG103 ø cm 100x35h
 Base: OPM6 RAL 9017 traffic black painted metal
 Top: OPP11 Grey Stone marble



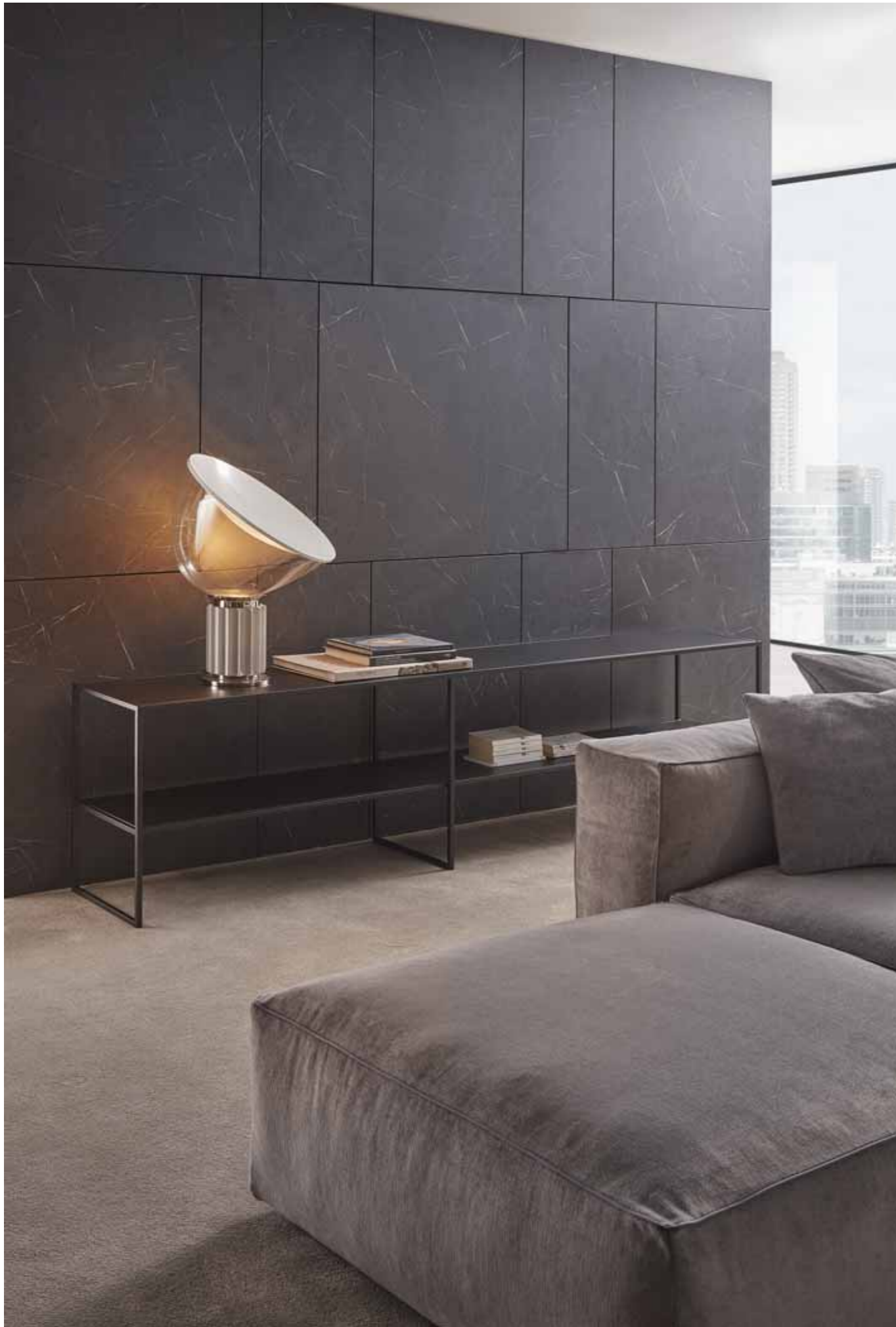

TWIG coffee tables
7TG101 ø cm 50x50h
7TG103 ø cm 100x35h
Base: OPM6 RAL 9017 traffic black painted metal
Top: OPP11 Grey Stone marble

- 1 - 9GY401
- 2 - 9GY503
- 3 - 9GY504

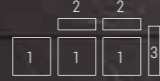

GARY composition cm 330x130x60h
3 x cushions with piping **9GY103 cm 60x60**
3 x cushions with piping **9GY102 cm 45x45**
Fabric: cat. G art. Dominique Kieffer/Rubelli art. Velour
Soleil col. 17189-013 Gris Perle

TWIG coffee table
7TG103 ø cm 100x35h
Base: OPM6 RAL 9017 traffic black painted metal
Top: OPP11 Grey Stone marble



Loft

DESIGN
STUDIO MARELLI
2013



marelli



LOFT 100 sofa
9LT204 cm 260x100x90h
Fabric: cat. E art. Dolomiti col. 42
Base: OPM6 RAL 9017 traffic black painted metal

Cushions:
2 x **9CU106 cm 45x45**
Fabric: cat. E art. Dolomiti col. 42
2 x **9VR102 cm 45x45** with band and "Punto Cavallo"
stitchings
Leather: cat. Extra art. Manhattan col. 2040

BREAK coffee tables:
7BR101 ø cm 40x45h
7BR120 cm 90x60x28h
Base: OPM14 shiny black chrome metal
Top: OPP1 Carrara white marble



LOFT 100 composition cm 295x320x90h
 Fabric: cat. G art. Kieffer by Rubelli Velour Soleil
 col. Naturel 17189-002
 Base D: OPM9 classic bronze painted metal

Cushions:
 2 x **9CU105 cm 50x50**
 3 x **9CU106 cm 45x45**
 Fabric: cat. G art. Kieffer by Rubelli Velour Soleil
 col. Naturel 17189-002
 1 x **9CU106 cm 45x45**
 1 x **9CU103 cm 40x40**
 Fabric: cat. H art. Rubelli Spritz col. 18 bronzo

JOY wing-back chair
9JY104 cm 75x82x99h
 Leather: cat. Lusso art. Nabuk col. C/3406 nocciola
 Swivel base: OPM15 antique gold brushed metal

BREAK coffee table
7BR101 ø cm 40x45h
 Base: OPM16 shiny brass chrome metal
 Top: OPP7 Calacatta gold marble

FRAME coffee table
7FR121 ø cm 100x28h
 Base: OPM15 antique gold brushed metal
 Top: OPP7 Calacatta gold marble

KYOTO sideboard
7KY208 cm 220x50x50h
 OPR15 moka matt stained oak structure
 OPP3 Emperador brown top
 OPM15 antique gold brushed metal base





JOY wing-back chair
9JY104 cm 75x82x99h
 Leather: cat. Lusso art. Nabuk col. C/3406 nocciola
 Swivel base: OPM15 antique gold brushed metal



KYOTO sideboard
7KY208 cm 220x50x50h
 OPR15 moka matt stained oak structure
 OPP3 Emperador brown top
 OPM15 antique gold brushed metal base



LOFT 100 composition with "Punto Cavallo" Stitchings cm 295x320
Leather: cat. Lusso art. Nabuk col. C/3405 Tartufo
Base: OPM18 anodyc bronze painted metal

TWIG coffee tables

7TG103 ø 100x35h

Base: OPM17 bronze metal

Top: OPP9 Black and Gold marble

7TG131 ø 50x50h

Base: OPM17 bronze metal

Top: OPV9 chrome back-painted bronze metal



PARIS armchairs
9PAR201X cm 73x75x76h
 Fabric: cat. E art. Delius Opera col. 1552
 Wooden base covered in the same fabric

TWIG coffee tables
7TG103 ø 100x35h
 Base: OPM17 bronze metal
 Top: OPP9 Black and Gold marble
7TG131 ø 50x50h
 Base: OPM17 bronze metal
 Top: OPV9 chrome back-painted bronze metal

LOFT 100 composition
 with "Punto Cavallo" Stitchings cm 295x320
 Leather: cat. Lusso art. Nabuk col. C/3405 Tartufo
 Base: OPM18 anodyc bronze painted metal

Cushions:
 2 x **9VR102 cm 45x45**
 with band and "Punto Cavallo" Stitchings
 2 x **9CU103 cm 40x40**
 Leather: cat. Lusso art. Nabuk col. C/3405 Tartufo
 2 x **9CU106 cm 45x45**
 Fabric: cat. E art. Delius Opera col. 1552

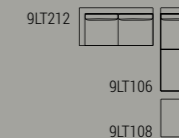



PARIS armchairs
9PAR201X cm 73x75x76h
Fabric: cat. E art. Delius Opera col. 1552
Wooden base covered in the same fabric

TWIG coffee table
7TC103 ø 100x35h
Base: OPM17 bronze metal
Top: OPP9 Black and Gold marble





Detail of **LOFT 100** sofa
with "Punto Cavallo" Stitchings



KYOTO cupboards
7KY209 cm 100x50x125h
OPR15 moka matt stained oak structure
OPP7 Calacatta gold marble top
OPM16 shiny brass chrome metal base



Mike

DESIGN
STUDIO MARELLI
2015

marelli



MIKE dining table
7MK102 cm 240x100x73h
Base: OPR15 moka matt stained oak
Top: OPP7 Calacatta gold marble

CHIA chair
9CHI105 cm 58x53x77h
Fabric: cat. H art. Sahco Flint col. 10
Base: OPR15 moka matt stained oak

MIKE dining table
7MK102 cm 240x100x73h
Base: OPR15 moka matt stained oak
Top: OPP7 Calacatta gold marble



CHIA chair
9CH105 cm 58x53x77h
Fabric: cat. H art. Sahco Flint col. 10
Base: OPR15 moka matt stained oak





Paris

DESIGN
ELEONORA POZZI
2016

marelli



PARIS
9PAR201 cm 73x75x76h armchairs
9PAR205 cm 165x75x76h sofa
 Leather: cat. Lusso art. Seta col. Ebanò, with "X Stitching"
 Base: covered in the same leather

TAB coffee table
7TAB113 ø cm 90x36h
 Base: OPM14 shiny black chrome metal
 Upper top: OPP7 Calacatta gold marble
 Lower top: OPV9 chrome back-painted bronze glass

DUNE coffee table
7DU111 ø cm 40x42h
 Base: OPR15 moka matt stained oak
 Top: OPV12 transparent bronze glass

PARIS sofa
9PAR205 cm 165x75x76h
Leather: cat. Lusso art. Seta col. Ebano, with "X Stitching"
Base: covered in the same leather



TAB coffee table
7TAB113 ø cm 90x36h
Base: OPM14 shiny black chrome metal
Upper top: OPP7 Calacatta gold marble
Lower top: OPV9 chrome back-painted bronze glass



PARIS
9PAR101 cm 53x61x90h chair
9PAR103 cm 59x61x83h small armchair
Leather: cat. Lusso art. Seta col. Ebano, with "X Stitching"
Base: covered in the same leather

TWIG dining table
7TG138 cm 240x120x74h
Base: OPM18 anodized bronze painted metal
Top: OPV12 transparent bronze glass





Detail of "X Stitching"

PARIS small armchair
9PAR103 cm 59x61x83h
Leather: cat. Lusso art. Seta col. Ebano, with "X Stitching"
Base: covered in the same leather





Atacama

DESIGN
MARCO CATTANEO
2020

marelli

ATACAMA
9ATC103 cm 185x105x80h sofa
9ATC106 cm 85x75x44h ottoman
 Fabric: cat. F art. Misia Aime col. Badiane M188-622 yellow
9ATC102 cm 225x145x80h sofa
9ATC107 cm 85x75x44h ottoman
 with OPV9 back-painted bronze glass top
 Fabric: cat. G art. Orsetto col. 09-23 blue

BREAK coffee tables:
7BR113 ø cm 80x27h
 Base: OPM17 bronze metal
 Top: OPR8 tobacco stained oak
7BR118 ø cm 60x36h
 Base: OPM17 bronze metal
 Top: OPV12 transparent bronze glass

TOM coffee table
7TM102 ø 40x50h
 OPT8 Tobacco stained tulipier



ATACAMA
9ATC106 cm 85x75x44h ottoman
Fabric: cat. F art. Misia Aime col. Badiane M188-622 yellow
9ATC107 cm 85x75x44h ottoman
with OPV9 back-painted bronze glass top
Fabric: cat. G art. Orsetto col. 09-23 blue



TOM coffee table
7TM102 ø 40x50h
OPT8 Tobacco stained tulipier

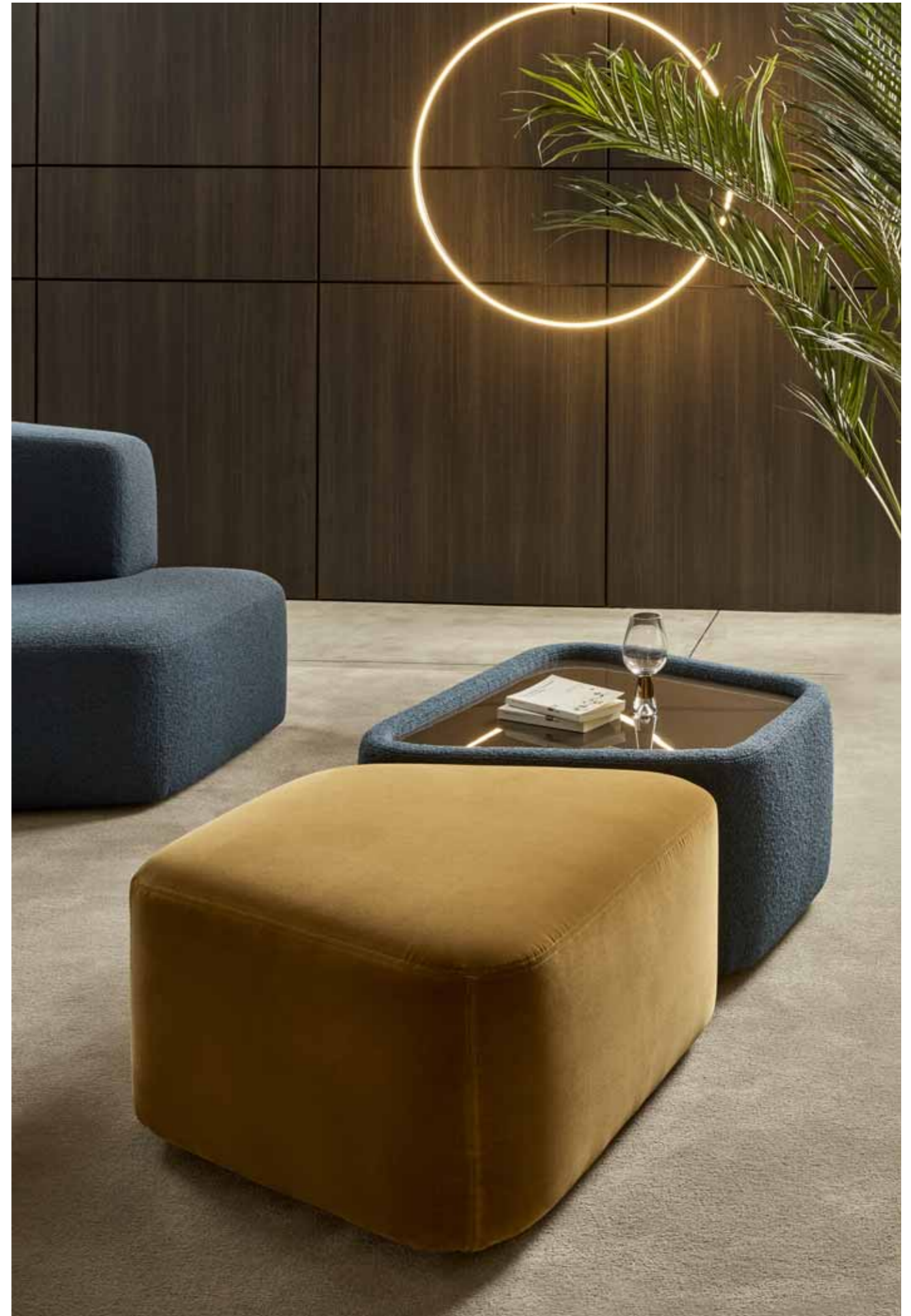



ATACAMA
9ATC104 cm 185x105x80h sofa
9ATC106 cm 85x75x44h ottoman
Fabric: cat. G Art. Orsetto 01/1



ATACAMA
9ATC104 cm 185x105x80h sofa
9ATC106 cm 85x75x44h ottoman
 Fabric: cat. G Art. Orsetto 01/1
9ATC101 cm 225x145x80h sofa
 Fabric: cat. E art. Vescom Fuga col. 7047.18

KYOTO coffee tables
7KY109 ø cm 100x38h
 Base: OPM16 shiny brass chrome metal
 Top: OPP2 Marquinia black marble
7KY102 ø cm 40x48h
 Base: OPM16 shiny brass chrome metal
 Top: OPV10 chrome back-painted grey glass
7KY103 ø cm 50x38h
 Base: OPM16 shiny brass chrome metal
 Top: OPP2 Marquinia black marble



ATACAMA sofa
9ATC101 cm 225x145x80h
Fabric: cat. E art. Vescom Fuga col. 7047.18

KYOTO coffee table
7KY103 ø cm 50x38h
Base: OPM16 shiny brass chrome metal
Top: OPP2 Marquinia black marble



KYOTO coffee tables
7KY109 ø cm 100x38h
Base: OPM16 shiny brass chrome metal
Top: OPP2 Marquinia black marble
7KY102 ø cm 40x48h
Base: OPM16 shiny brass chrome metal
Top: OPV10 chrome back-painted grey glass



Andy

DESIGN
STUDIO MARELLI
2011

marelli

ANDY composition cm 325x200x65h
Fabric: cat. E art. Baltimore col. 12
Base: OPM6 traffic black painted metal

Cushions:
3 x **9CU103 cm 40x40**
Fabric: cat. G art. Velours Soleil by Kieffer
col. Naturel 17189-002
9CU106 cm 45x45
Leather: cat. Lusso art. Brevia col. P-4202 Bruno

DUNE coffee table
7DU116 ø cm 125x37h
Base: OPR15 moka matt
with OPM15 antique gold brushed metal
Glass top: OPV12 transparent bronze glass

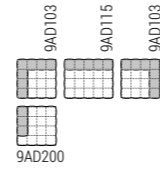



ANDY + MATHEUS composition cm 400x405
 Fabric: cat. H art. Rubelli Spritz col. 15 Sabbia
 Leather: cat. Lusso art. Nabuk C3406
 Base: OPM17 bronze metal

Extra cushions:
 1 x **9CU104 cm 60x60**
 1 x **9CU103 cm 40x40**
 Fabric: cat. H art. Rubelli Spritz col. 16 moro

2 x **9CU106 cm 45x45**
 Fabric: cat. H art. Rubelli Spritz col. 15 sabbia

1 x **9CU106 cm 45x45**
 2 x **9CU104 cm 60x60**
 Fabric: cat. E art. Dolomiti col. 28



CLIPPER armchairs
9CLX107 cm 70x76x75h
 External side: leather cat. Lusso art. Nabuk col. C3407 mogano
 Internal side: fabric cat. E art. Dolomiti col. 28
 Base: OPM17 bronze metal
KYOTO coffee tables:
7KY101 ø cm 40x48h
 Base: OPM16 shiny brass chrome metal
 Top: OPP7 Calacatta gold marble

7KY109 ø cm 100x38h
 Base: OPM18 anodized bronze painted metal
 Top: OPP7 Calacatta gold marble

THOR side table
7TH111 cm 80x80x27h
 OPP7 Calacatta gold marble
 with OPM15 antique gold brushed metal base

ELLE coffee tables:
7EL109 cm 60x60x27h
7EL107 cm 50x50x43h
 OPM15 antique gold brushed metal

ANDY + MATHEUS composition cm 400x405
 Fabric: cat. H art. Rubelli Spritz col. 15 Sabbia
 Leather: cat. Lusso art. Nabuk C3406
 Base: OPM17 bronze metal

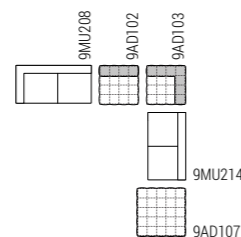

Extra cushions:
 1 x **9CU104 cm 60x60**
 1 x **9CU103 cm 40x40**
 Fabric: cat. H art. Rubelli Spritz col. 16 moro

2 x **9CU106 cm 45x45**
 Fabric: cat. H art. Rubelli Spritz col. 15 sabbia

1 x **9CU106 cm 45x45**
 2 x **9CU104 cm 60x60**
 Fabric: cat. E art. Dolomiti col. 28

CLIPPER armchairs
9CLX107 cm 70x76x75h
 External side: leather cat. Lusso art. Nabuk col. C3407 mogano
 Internal side: fabric cat. E art. Dolomiti col. 28
 Base: OPM17 bronze metal
KYOTO coffee tables:
7KY101 ø cm 40x48h
 Base: OPM16 shiny brass chrome metal
 Top: OPP7 Calacatta gold marble

7KY109 ø cm 100x38h
 Base: OPM18 anodyc bronze painted metal
 Top: OPP7 Calacatta gold marble

THOR side table
7TH111 cm 80x80x27h
 OPP7 Calacatta gold marble
 with OPM15 antique gold brushed metal base

ELLE coffee tables:
7EL109 cm 60x60x27h
7EL107 cm 50x50x43h
 OPM15 antique gold brushed metal

CLIP HEXAGONAL side table
7CLX101 ø cm 40x50h
 OPM17 bronze metal





CLIPPER armchairs
9CLX107 cm 70x76x75h
External side: leather cat. Lusso art. Nabuk col. C3407 mogano
Internal side: fabric cat. E art. Dolomiti col. 28
Base: OPM17 bronze metal

CLIP HEXAGONAL side table
7CLX101 ø cm 40x50h
OPM17 bronze metal



Detail of **MATHEUS** sofa and **THOR** side table
in Calacatta marble

Matheus

DESIGN
STUDIO MARELLI
2015



marelli

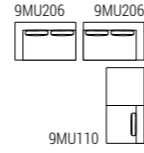

MATHEUS composition cm 320x300x88h
Fabric: cat. E art. Baltimora col. 10
Base: OPM9 classic bronze painted metal

Extra Cushions:
2 x **9CU103 cm 40x40**
Fabric: cat. H art. Rubelli Spritz col. 25 Lichene
1 x **9CU105 cm 50x50**
Fabric: cat. E art. Burri col. 6

CLIPPER swivel armchairs
9CLX104 cm 70x80x91h
Fabric: cat. E art. Burri col. 6
Swivel base: OPM6 RAL 9017 traffic black painted metal

TWIG coffee tables
7TG103 ø cm 100x35h
7TG101 ø cm 50x50h
Base: OPM6 RAL 9017 traffic black painted metal
Top: OPP11 Grey Stone marble

CLIP coffee table
7CL117 ø cm 40x40h
OPM14 shiny black chrome metal

ELLE side table
7EL109 cm 60x60x27h
OPM6 RAL 9017 traffic black painted metal



CLIPPER swivel armchair
9CLX104 cm 70x80x91h
Fabric: cat. E art. Burri col. 6
Swivel base: OPM6 RAL 9017 traffic black painted metal

CLIP coffee table
7CL117 ø cm 40x40h
OPM14 shiny black chrome metal



TWIG coffee tables
7TG103 ø cm 100x35h
7TG101 ø cm 50x50h
Base: OPM6 RAL 9017 traffic black painted metal
Top: OPP11 Grey Stone marble



MATHEUS sofa
9MU204 cm 240x100x88h
 Fabric: cat. E art. Baltimora col. 35
 Base: OPM14 shiny black chrome metal

Extra cushions:
 2 x **9CU103 cm 40x40**
 Fabric: cat. E art. Baltimora col. 35
 1 x **9CU103 cm 40x40**
 Leather: cat. Lusso art. Seta col. Militare

JOY swivel armchair
9JY101 cm 75x82x99h
 Leather: cat. Lusso art. Seta col. Militare
 Base: OPM17 bronze metal

DUNE coffee table
7DU108 ø cm 80x37h
 Base: OPR15 moka matt stained oak + OPM14 shiny
 black chrome metal
 Top: OPP7 Calacatta gold marble

CLIP coffee table
7CL118 ø cm 40x50h
 OPM14 shiny black chrome metal

THOR side table
7TH111 cm 80x80x27h
 OPP11 Grey Stone marble
 Base: OPM14 shiny black chrome metal





MATHEUS curved composition cm 376x255x88h
Fabric: cat. E art. Dolomiti col. 35

Extra cushions:
2 x **9CU103 cm 40x40**
Fabric: cat. H art. Rubelli Spritz col. 11 ambra

CLIP coffee tables
7CL127 ø cm 100x27h
Base: OPM15 antique gold brushed metal
Top: OPP11 Grey Stone marble
7CL117 ø cm 40x40h
OPM15 antique gold brushed metal





LEAF side table
7LE101 cm 64x25x51h
OPM15 antique gold brushed metal

MINI side table
9TX106 cm 25x40x50h
OPM15 antique gold brushed metal



MATHEUS curved composition and
CLIP coffee table
7CL127 ø cm 100x27h
Base: OPM15 antique gold brushed metal
Top: OPP11 Grey Stone marble



Kyoto

DESIGN
MARCO CATTANEO
2019

marelli

KYOTO dining table
7KY205 cm 250x110x74h
Base: OPM14 shiny black chrome metal
Top: OPP15 Covelano white marble

CHIA small armchairs
9CHI104 cm 58x53x77h
Fabric: cat. C art. Pantera col. 21
Base: OPM6 RAL 9017 traffic black painted metal





New York

DESIGN
STUDIO MARELLI
2011

marelli

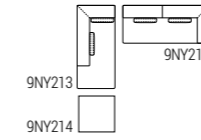

NEW YORK composition cm 330x320x85h
Fabric: cat. E art. Delius Elvin col. 1551
Base: OPM18 anodyc bronze painted metal

Cushions:
2 x **9NY103 cm 50x50** with band
Fabric: cat. F art. Misia Aime col. Badiane col. M188-622
2 x **9CU103 cm 40x40**
Fabric: cat. E art. Delius Elvin col. 1551

JOY armchairs
9JY105 cm 75x82x79h
Fabric: cat. C art. San Diego col. 3
Base: OPM6 RAL 9017 traffic black painted metal

KYOTO coffee tables
7KY111 cm 120x60x38h
Base: OPM18 anodyc bronze painted metal
Top: OPP3 Emperador brown marble
7KY102 cm 40x48h
Base: OPM18 anodyc bronze painted metal
Top: OPV9 chrome back-painted bronze glass





NEW YORK composition cm 330x320x85h
 Fabric: cat. E art. Delius Elvin col. 1551
 Base: OPM18 anodyc bronze painted metal

Cushions:
 2 x **9NY103 cm 50x50** with band
 Fabric: cat. F art. Misa Aime col. Badiane col. M188-622
 2 x **9CU103 cm 40x40**
 Fabric: cat. E art. Delius Elvin col. 1551

KYOTO coffee table
7KY111 cm 120x60x38h
 Base: OPM18 anodyc bronze painted metal
 Top: OPP3 Emperador brown marble

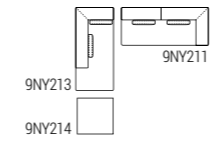

JOY armchairs
9JY105 cm 75x82x79h
 Fabric: cat. C art. San Diego col. 3
 Base: OPM6 RAL 9017 traffic black painted metal

NEW YORK curved composition cm 430x149x85h
Fabric: cat. F art. Misia Aime col. M188-604 Grege
Base: OPM18 Anodyc bronze painted metal

Extra cushions:
1 x **9CU106 cm 45x45**
Leather: cat. Lusso art. Brevia col. P-4202 Bruno
1 x **9CU103 cm 40x40**
Fabric: cat. F art. Misia Aime col. M188-907 Cacao



9NY217 9NY218

WELL swivel armchairs
9WX102 cm 70x70x80h
Fabric: cat. F art. Misia Aime col. M188-310 Ardoise
Base: OPM15 antique gold brushed metal

ELLE coffee tables
7EL204 cm 50x50x43h
7EL206 cm 60x60x27h
Base: OPM15 antique gold brushed metal
Top: OPG3 Statuario Select Porcelaine Stoneware

FRAME coffee table
7FR121 ø cm 100x28h
Base: OPM15 antique gold brushed metal
Top: OPG3 Statuario Select Porcelaine Stoneware





WELL swivel armchairs
9WX102 cm 70x70x80h
 Fabric: cat. F art. Misia Aime col. M188-310 Ardoise
 Base: OPM15 antique gold brushed metal

FRAME coffee table
7FR121 ø cm 100x28h
 Base: OPM15 antique gold brushed metal
 Top: OPG3 Statuario Select Porcelaine Stoneware

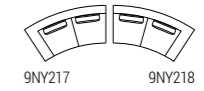

NEW YORK curved composition cm 430x149x85h
 Fabric: cat. F art. Misia Aime col. M188-604 Grege
 Base: OPM18 Anodyc bronze painted metal

Extra cushions:
 1 x **9CU106 cm 45x45**
 Leather: cat. Lusso art. Brevia col. P-4202 Bruno
 1 x **9CU103 cm 40x40**
 Fabric: cat. F art. Misia Aime col. M188-907 Cacao

ELLE coffee tables
7EL204 cm 50x50x43h
7EL206 cm 60x60x27h
 Base: OPM15 antique gold brushed metal
 Top: OPG3 Statuario Select Porcelaine Stoneware





L-Sofa

DESIGN
JÉRÔME GAUTHIER
2013

marelli

L-SOFA armchair and sofa
9LF101 cm 112x78x70h
9LF207 cm 260x78x70h
 Leather: cat. Lusso art. Seta col. Biscotto
 with "Punto Cavallo" Stitchings
 Metal base: OPM14 shiny chrome metal
 Wooden panels: OPR8 tobacco stained oak

Cushions:
 2 x **9CU106 cm 45x45**
 Leather: cat. Lusso art. Nabuk col. Marrone scuro

KYOTO coffee table
7KY109 ø cm 100x38h
 Base: OPM14 shiny chrome metal
 Top: OPP3 Emperador brown marble

CLIP coffee table
9CL117 ø cm 40x40h
 OPM15 antique gold brushed metal





KYOTO coffee table
7KY109 ø cm 100x38h
Base: OPM14 shiny chrome metal
Top: OPP3 Emperador brown marble





THOR tables
7TH103 cm 40x40x40h
 OPP15 Covelano white marble
 with OPM14 shiny black chrome metal

L-SOFA sofa
9LF202 cm 220x78x70h
 Fabric: cat. E art. Burri col. 5
 Base: OPM1 shiny chrome metal
 Wooden panels: OPR5 black stained oak

Cushions:
 2 x **9CU106 cm 45x45**
 Fabric: cat. E art. Burri col. 5

THOR tables
7TH103 cm 40x40x40h
 OPP15 Covelano white marble
 with OPM14 shiny black chrome metal
7TH104 cm 50x50x50h
 OPP15 Covelano white marble



L-SOFA sofa
9LF202 cm 220x78x70h
Fabric: cat. E art. Burri col. 5
Base: OPM1 shiny chrome metal
Wooden panels: OPR5 black stained oak

Cushions:
2 x **9CU106 cm 45x45**
Fabric: cat. E art. Burri col. 5

THOR tables
7TH115 cm 60x60x27h
OPP15 Covelano white marble
with OPM14 shiny black chrome metal
7TH104 cm 50x50x50h
OPP15 Covelano white marble





William

DESIGN
STUDIO MARELLI
2020

marelli

**WILLIAM** sofa with chaise longue **cm 320x140x84h**

Leather: cat. Lusso art. Nabuk col. Terra
 Feet: OPM9 classic bronze painted metal

Cushions:

2 x **9CU103 cm 40x40**

Leather: cat. Lusso art. Nabuk col. Terra

2 x **9VR102 cm 45x45** with band

Fabric: cat. G art. Orsetto 98/16

TAB coffee tables:

7TAB111 ø cm 60x36h

Base: OPM9 classic bronze painted metal

Upper base: OPP3 Emperador brown marble

Lower base: OPV9 chrome back-painted bronze glass

7TAB118 cm 120x70x36h

Base: OPM16 shiny brass chrome metal

Upper base: OPP3 Emperador brown marble

Lower base: OPV9 chrome back-painted bronze glass



WILLIAM sofa
9WIL205 cm 320x100x84h
Fabric: cat. E art. Baltimora col. 10
Feet: OPM9 classic bronze painted metal

Cushions:
3 x **9CU106 cm 45x45**
Fabric: cat. E art. Baltimora col. 10
1 x **9MU101 cm 50x50** with band
Fabric: cat. G art. Orsetto 98/16

DUNE coffee table
7DU103 cm 130x80x37h
Base: OPR5 black stained oak base with OPM15 antique
gold brushed metal
Top: OPP2 Marquinia black marble





THOR side table
7TH212 cm 100x100x27h
OPM15 antique gold brushed metal



FRAME server table
7FR127 cm 55x27x51,5h
Base: OPM15 antique gold brushed metal
Top: OPP9 Black and Gold marble

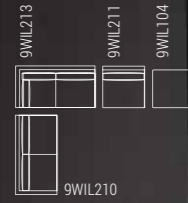

WILLIAM composition **cm 320x420x84h**
 Fabric: cat. E art. Baltimora col. 10
 Feet: OPM9 classic bronze painted metal

Cushions:
 4 x **9CU106 cm 45x45**
 Fabric: cat. E art. Baltimora col. 10
 1 x **9CU106 cm 45x45**
 1 x **9CU105 cm 50x50**
 Fabric: cat. E art. Baltimora col. 27

TAB coffee table
7TAB118 cm 120x70x36h
 Base: OPM16 shiny brass chrome metal
 Upper base: OPP3 Emperador brown marble
 Lower base: OPV9 chrome back-painted bronze glass

CLIP coffee table
7CL126 ø cm 40x50h
 Base: OPM15 antique gold brushed metal
 Top: OPP9 Black and Gold marble



TAB coffee table
7TAB118 cm 120x70x36h
Base: OPM16 shiny brass chrome metal
Upper base: OPP3 Emperador brown marble
Lower base: OPV9 chrome back-painted bronze glass



CLIP coffee table
7CL126 ø cm 40x50h
Base: OPM15 antique gold brushed metal
Top: OPP9 Black and Gold marble





Twig

DESIGN
STUDIO MARELLI
2017

marelli

TWIG dining table
7TG138 cm 240x120x74h
Base: OPM18 anodized bronze painted metal
Top: OPV12 transparent bronze glass

NICOLE chairs
9NK101 cm 53x56x91h
Fabric: cat. H art. Sahco Kent col. 003
Base: OPR15 moka matt stained oak





NICOLE chair with armrests
9NK103 cm 56x56x91h
Fabric: cat. H art. Sahco Kent col. 003
Base: OPR15 moka matt stained oak



NICOLE chair
9NK101 cm 53x56x91h
Fabric: cat. H art. Sahco Kent col. 003
Base: OPR15 moka matt stained oak



TWIG dining table
7TG138 cm 240x120x74h
Base: OPM18 anodized bronze painted metal
Top: OPV12 transparent bronze glass





TWIG dining table
7TG134 cm 240x120x74h
Base: OPM18 anodized bronze painted metal
Top: OPP14 Amani bronze marble

PARIS
9PAR101 cm 53x61x90h chair
9PAR103 cm 59x61x83h small armchair
Fabric: cat. C art. Koala col. 100
Base covered in the same fabric



PARIS small armchair
9PAR103 cm 59x61x83h
Fabric: cat. C art. Koala col. 100
Base covered in the same fabric

Detail of OPP14 Amami bronze marble



Gordon

DESIGN
STUDIO MARELLI
2014

marelli

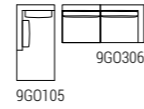

9G0105

9G0306

GORDON composition cm 315x200x86h
Fabric: cat. E art. Baltimora col. 4
Feet: OPM15 antique gold brushed metal

Cushions:
2 x **9G0105 cm 45x45** with band
Fabric: cat. E art. Baltimora col. 4
2 x **9G0105 cm 45x45** with band
Fabric: cat. F art. Misia Aime col. Badiane M188-622

CLIPPER armchairs
9CLX105 cm 70x76x75h
Fabric: cat. F art. Misia Aime col. Badiane M188-622

TWIG coffee table
7TG134 cm 120x71x35h
Base: OPM14 shiny black chrome metal
Top: OPV10 chrome back-painted grey glass

BREAK coffee table
7BR117 cm 40x45h
Base: OPM3 matt brushed dark grey metal
Top: OPV13 transparent grey glass

THOR side table
7TH111 cm 80x80x27h
OPP11 Grey Stone marble
Base: OPM2 matt brushed chrome metal



TWIG coffee table
7TG134 cm 120x71x35h
Base: OPM14 shiny black chrome metal
Top: OPV10 chrome back-painted grey glass

CLIPPER armchairs
9CLX105 cm 70x76x75h
Fabric: cat. F art. Misia Aime col. Badiane M188-622

BREAK coffee table
7BR118 ø cm 60x36h
Base: OPM1 shiny chrome metal
Top: OPV13 Transparent grey glass



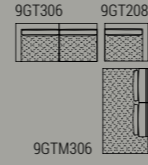

GORDON QUILTED composition cm 330x325x86h
Leather: cat. Lusso art. Seta col. Creta
Feet: OPM6 RAL 9017 traffic black painted metal

Cushions:
3 x **9G0105 cm 45x45** with band
Leather: cat. Lusso art. Seta col. Creta
2 x **9G0105 cm 45x45** with band
Fabric: cat. C art. San Diego col. 13

PARIS armchairs
9PAR201 cm 73x75x76h
Fabric: cat. C art. San Diego col. 13
Base: OPR8 Tobacco stained oak

TWIG coffee table
7TG104 cm 120x71x35h
Base: OPM14 shiny black chrome metal
Top: OPP15 Covelano white marble





GORDON QUILTED composition cm 330x325x86h
 Leather: cat. Lusso art. Seta col. Creta
 Feet: OPM6 RAL 9017 traffic black painted metal

Cushions:
 3 x **9G0105 cm 45x45** with band
 Leather: cat. Lusso art. Seta col. Creta
 2 x **9G0105 cm 45x45** with band
 Fabric: cat. C art. San Diego col. 13

PARIS armchairs
9PAR201 cm 73x75x76h
 Fabric: cat. C art. San Diego col. 13
 Base: OPR8 Tobacco stained oak

TWIG coffee table
7TG104 cm 120x71x35h
 Base: OPM14 shiny black chrome metal
 Top: OPP15 Covelano white marble

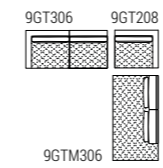







Colori e finiture

COLOURS AND FINISHES

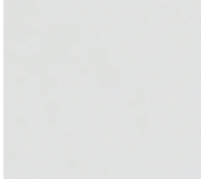
marelli

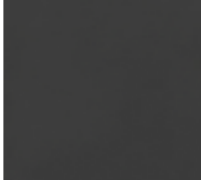





Finiture metallo

METAL FINISHES

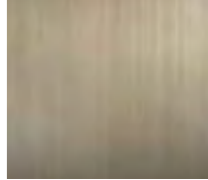
<p>OPM1 Metallo cromo lucido <i>Shiny chrome metal</i> Metall glänzend verchromt Métal chromé brillant</p>		<p>OPM7 Metallo verniciato RAL 9016 bianco <i>RAL 9016 white painted metal</i> Metall RAL 9016 weiss lackiert Métal laqué blanc RAL 9016</p>	
<p>OPM2 Metallo spazzolato cromo satinato <i>Brushed matt chrome metal</i> Metall matt verchromt (gebürstet) Métal chromé mat (brossé)</p>		<p>OPM9 Metallo verniciato classic bronze <i>Classic bronze painted metal</i> Metall classic bronze lackiert Métal laqué classic bronze</p>	
<p>OPM3 Metallo spazzolato canna di fucile <i>Brushed matt dark grey metal</i> Metall dunkelgrau gebürstet Métal brossé canon de fusil</p>		<p>OPM10 Metallo verniciato golden beach <i>Golden beach painted metal</i> Metall golden beach lackiert Métal laqué golden beach</p>	
<p>OPM6 Metallo verniciato RAL 9017 nero <i>RAL 9017 black painted metal</i> Metall RAL 9017 schwarz lackiert Métal laqué noir RAL 9017</p>			





Finiture metallo

METAL FINISHES

<p>OPM11 Metallo verniciato gold pearl <i>Gold pearl painted metal</i> Metall gold pearl lackiert Métal laqué gold pearl</p>		<p>OPM15 Metallo spazzolato oro antico <i>Brushed antique gold metal</i> Metall Antik gold gebürstet Métal brossé or antique</p>	
<p>OPM12 Metallo spazzolato rame <i>Brushed copper metal</i> Metall Kupfer gebürstet Métal brossé cuivre</p>		<p>OPM16 Metallo cromo ottone lucido <i>Shiny brass chrome metal</i> Metall Messing glänzend verchromt Métal chromé laiton brillant</p>	
<p>OPM13 Metallo spazzolato ottone antico <i>Brushed antique brass metal</i> Metall Antik Messing gebürstet Métal brossé laiton antique</p>		<p>OPM17 Metallo bronzo <i>Bronze metal</i> Metallica Bronze Métal bronze</p>	
<p>OPM14 Metallo cromo nero lucido <i>Shiny black chrome metal</i> Metall schwarz glänzend verchromt Métal chromé noir brillant</p>		<p>OPM18 Metallo verniciato anodyc bronze <i>Anodyc bronze painted metal</i> Métal laqué anodyc bronze Metall Anodyc Bronze lackiert</p>	

Finiture rovere

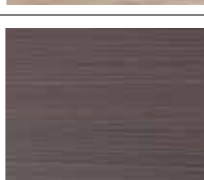
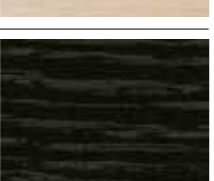
OAK FINISHES

OPR1 Rovere tinto ciliegio <i>Cherry stained oak</i> <i>Eiche Kirschbaum gebeizt</i> <i>Chêne teinté merisier</i>		OPR8 Rovere tinto tabacco <i>Tobacco stained oak</i> <i>Eiche tabak gebeizt</i> <i>Chêne teinté tabac</i>	
OPR2 Rovere tinto wengé <i>Wengé stained oak</i> <i>Eiche Wenge gebeizt</i> <i>Chêne teinté wengé</i>		OPR9 Rovere tinto grigio tortora <i>Grey taupe stained oak</i> <i>Eiche beige-grau gebeizt</i> <i>Chêne teinté taupe</i>	
OPR3 Rovere tinto noce <i>Walnut stained oak</i> <i>Eiche Nussbaum gebeizt</i> <i>Chêne teinté noyer</i>		OPR10 Rovere sbiancato <i>Whitened oak</i> <i>Eiche gebleicht</i> <i>Chêne blanchi</i>	
OPR4 Rovere tinto naturale <i>Natural oak</i> <i>Eiche natur farblos lackiert</i> <i>Chêne naturel</i>		OPR11 Rovere tinto antracite <i>Charcoal stained oak</i> <i>Eiche Anthrazit gebeizt</i> <i>Chêne teinté anthracite</i>	
OPR5 Rovere tinto nero <i>Black stained oak</i> <i>Eiche schwarz gebeizt</i> <i>Chêne teinté noir</i>		OPR12 Rovere tinto mogano <i>Mahogany stained oak</i> <i>Eiche mahagonifarbig gebeizt</i> <i>Chêne teinté acajou</i>	
OPR6 Rovere tinto ciliegio Milano <i>Cherry Milano stained oak</i> <i>Eiche Kirschbaum Milano gebeizt</i> <i>Chêne teinté merisier Milano</i>		OPR15 Rovere tinto moka opaco <i>Moka matt stained oak</i> <i>Eiche moka matt gebeizt</i> <i>Chêne teinté moka mat</i>	

Finiture vetro

GLASS FINISHES

OPV1 Vetro trasparente <i>Transparent glass</i> <i>Klarglas</i> <i>Verre transparent</i>		OPV7 Vetro retroverniciato nei colori RAL Classic <i>Glass back-painted in the RAL Classic colours</i> <i>Von hinten lackiertes Glas in den RAL Classic Farben</i> <i>Verre laqué de dessous dans les couleurs RAL Classic</i>	Colori RAL standard RAL standard colours
OPV2 Vetro satinato <i>Frosted glass</i> <i>Mattglas</i> <i>Verre dépoli</i>		OPV9 Vetro bronzato retroverniciato cromo <i>Chrome back-painted bronze glass</i> <i>Von hinten chromlackiertes Bronzenglas</i> <i>Verre bronzé laqué de dessous chrome</i>	
OPV3 Vetro retroverniciato RAL 9016 bianco traffico <i>RAL 9016 traffic white back-painted glass</i> <i>RAL 9016 verkehrsweiß von hinten lackiertes Glas</i> <i>Verre laqué de dessous RAL 9016 blanc signalisation</i>		OPV10 Vetro grigio retroverniciato cromo <i>Chrome back-painted grey glass</i> <i>Von hinten chromlackiertes Grauglas</i> <i>Verre gris laqué de dessous chrome</i>	
OPV4 Vetro retroverniciato RAL 9017 nero traffico <i>RAL 9017 traffic black back-painted glass</i> <i>RAL 9017 verkehrsschwarz von hinten lackiertes Glas</i> <i>Verre laqué de dessous RAL 9017 noir signalisation</i>		OPV12 Vetro bronzato trasparente <i>Transparent bronze glass</i> <i>Klarglas bronze</i> <i>Verre transparent bronzé</i>	
OPV5 Vetro retroverniciato RAL 7044 grigio seta <i>RAL 7044 silk grey back-painted glass</i> <i>RAL 7044 seidengrau von hinten lackiertes Glas</i> <i>Verre laqué de dessous RAL 7044 gris soie</i>		OPV13 Vetro grigio trasparente <i>Transparent grey glass</i> <i>Klarglas grau</i> <i>Verre transparent gris</i>	
OPV6 Vetro retroverniciato RAL 1019 beige grigiastro <i>RAL 1019 grey beige back-painted glass</i> <i>RAL 1019 graubeige von hinten lackiertes Glas</i> <i>Verre laqué de dessous RAL 1019 beige gris</i>			

Finiture marmi e pietre

MARBLES AND STONES FINISHES

OPP1

Marmo Carrara bianco
Carrara white marble
Marmor Carrara weiss
Marbre blanc Carrara



OPP11

Marmo Grey Stone
Grey Stone marble
Marmor Grey Stone
Marbre Grey Stone



OPP2

Marmo nero Marquinia
Marquinia black marble
Marmor Marquinia schwarz
Marbre noir Marquinia



OPP12

Marmo Verde Guatemala
Guatemala green marble
Marmor Guatemala grün
Marbre vert Guatemala



OPP3

Marmo Emperador marrone
Emperador brown marble
Marmor Emperador braun
Marbre brun Emperador



OPP13

Marmo Velvet brown
Velvet brown marble
Marmor Velvet brown
Marbre Velvet brown



OPP7

Marmo Calacatta oro
Calacatta gold marble
Marmor Calacatta gold
Marbre Calacatta or



OPP14

Marmo Amani Bronze
Amani Bronze marble
Marmor Amani Bronze
Marbre Amani Bronze



OPP9

Marmo Black and gold
Black and gold marble
Marmor Black and gold
Marbre Black and gold



OPP15

Marmo Bianco Covelano
Covelano white marble
Marmor Covelano weiss
Marbre blanc Covelano



OPP10

Marmo Perfetto brown
Perfetto brown marble
Marmor Perfetto braun
Marbre brun Perfetto



OPP4

Pietra Serena grigia
Grey Serena stone
Grauer Serena Stein
Pierre grise Serena

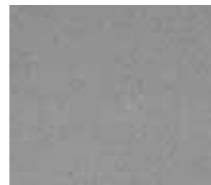

OPP5

Pietra di Brera beige
Beige Brera stone
Beige Brera Stein
Pierre beige Brera



Finiture gres porcellanato effetto marmo

PORCELAIN STONEWARE MARBLE EFFECT FINISHES

OPG1 Carrara Pure

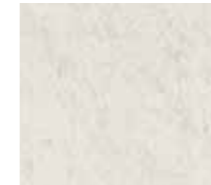

OPG3 Statuario Select



OPG2 Nero Marquinia



OPG4 Calacatta Royal

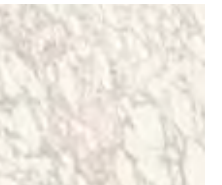

Schede tecniche

TECHNICAL INFORMATION

marelli

Andy

DESIGN
STUDIO MARELLI
2011

Caratteristica del modello è la tipica lavorazione a "trapuntatura" fatta a mano. Struttura: legno massello e pannelli multistrato rivestiti in poliuretano espanso e dacron. Seduta: imbottitura in poliuretano espanso a quote differenziate di 30 e 40 kg/mc, rivestita con fibre termolegate. Schienale: imbottitura in poliuretano espanso a quote differenziate di 30 e 40 kg/mc, rivestita con fibre termolegate. Rivestimento non sfoderabile.

Die Besonderheit von diesem Modell ist die typische abgestepte Ausführung, völlig handgetun. Gestell: Massivholz und Multischichtplatten, von Schaumstoff-Polyurethane und Dacron bezogen. Sitzfläche: Polsterung aus unterschiedlich dichtem Schaumstoff-Polyurethane, Dichte 30 und 40 Kg/m³, in thermogebundenen Fasern bezogen. Rückenlehne: Polsterung aus unterschiedlich dichtem Schaumstoff-Polyurethane, Dichte 30 und 40 Kg/m³, in thermogebundenen Fasern bezogen. Bezug: nicht abziehbar.

The peculiarity of this model is the typical "quilting" manufacturing, all handmade. Frame: solid wood and multi-layer panels covered in polyurethane foam and dacron. Seat: padding in polyurethane foam, in differentiated densities of 30 and 40 Kg/m³, covered with thermobound fibres. Back: padding in polyurethane foam in differentiated densities of 30 and 40 Kg/m³, covered with thermobound fibres. Cover: not removable

Главная отличительная особенность данной модели это прошивка по отсекам, сделанная вручную. Каркас: массив дерева в сочетании с многослойной фанерой, пенополиуретан, дакрон. Сиденье: наполнение из пенополиуретана различной плотности, 30 и 40 кг/м³, с покрытием из термосвязанных волокон. Спинка: наполнение из пенополиуретана различной плотности, 30 и 40 кг/м³ с покрытием из термосвязанных волокон. Чехлы: несъемные

La particularité de ce modèle est la typique finition pi-quée toute faite à main. Structure: bois massif et panneaux multicouche recouverts de polyuréthane expansé et dacron. Assise: rembourrage de polyuréthane expansé avec densités différenciées, densité 30 et 40 Kg/m³ recouverts de fibres thermoliées. Dossier: rembourrage de poliuréthane expansé avec densités différenciées, densité 30 et 40 Kg/m³ recouverts de fibres thermoliées. Revêtement: pas déhoussable

Andy

DESIGN
STUDIO MARELLI
2011

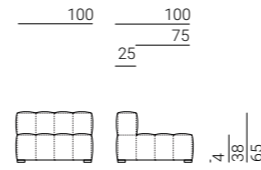

Elementi di seduta Seat elements

Elementi laterali con schienale e bracciolo
Corner elements with backrest and armrest

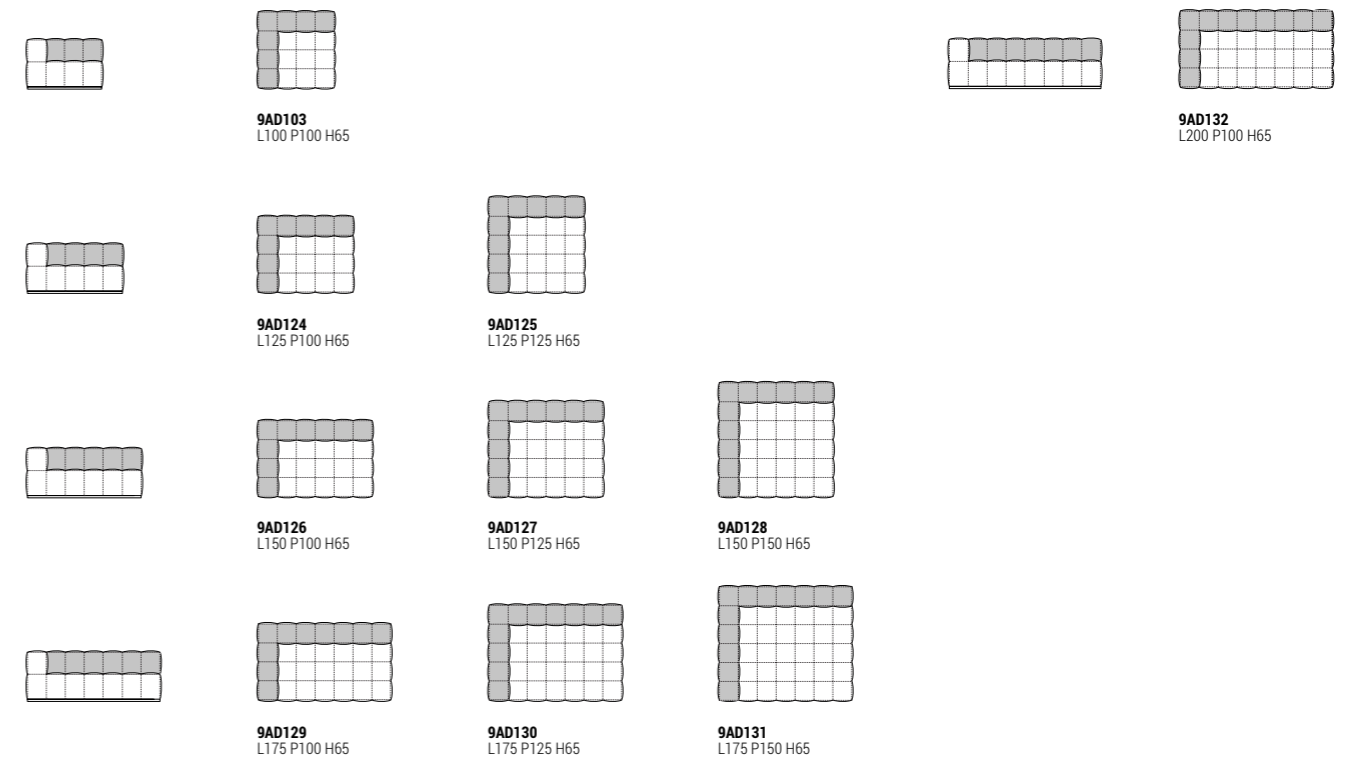

Finiture base Base finishes

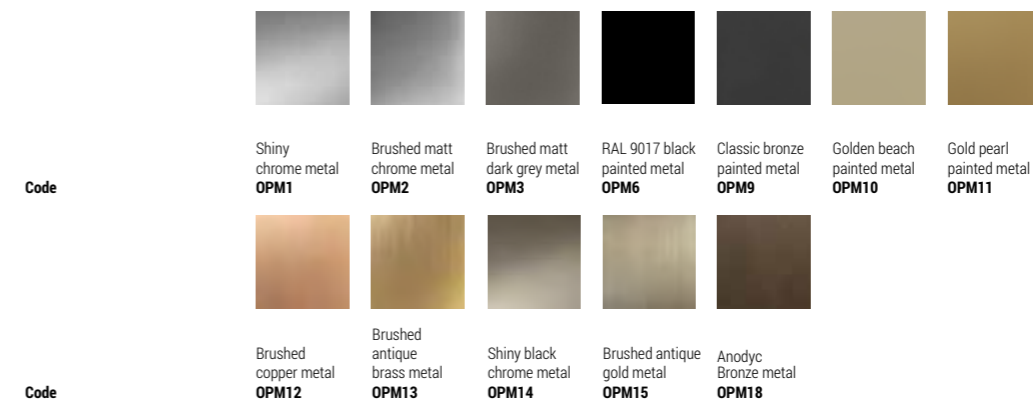

Elementi di seduta
Seat elements

Elementi centrali con schienale
Central elements with backrest

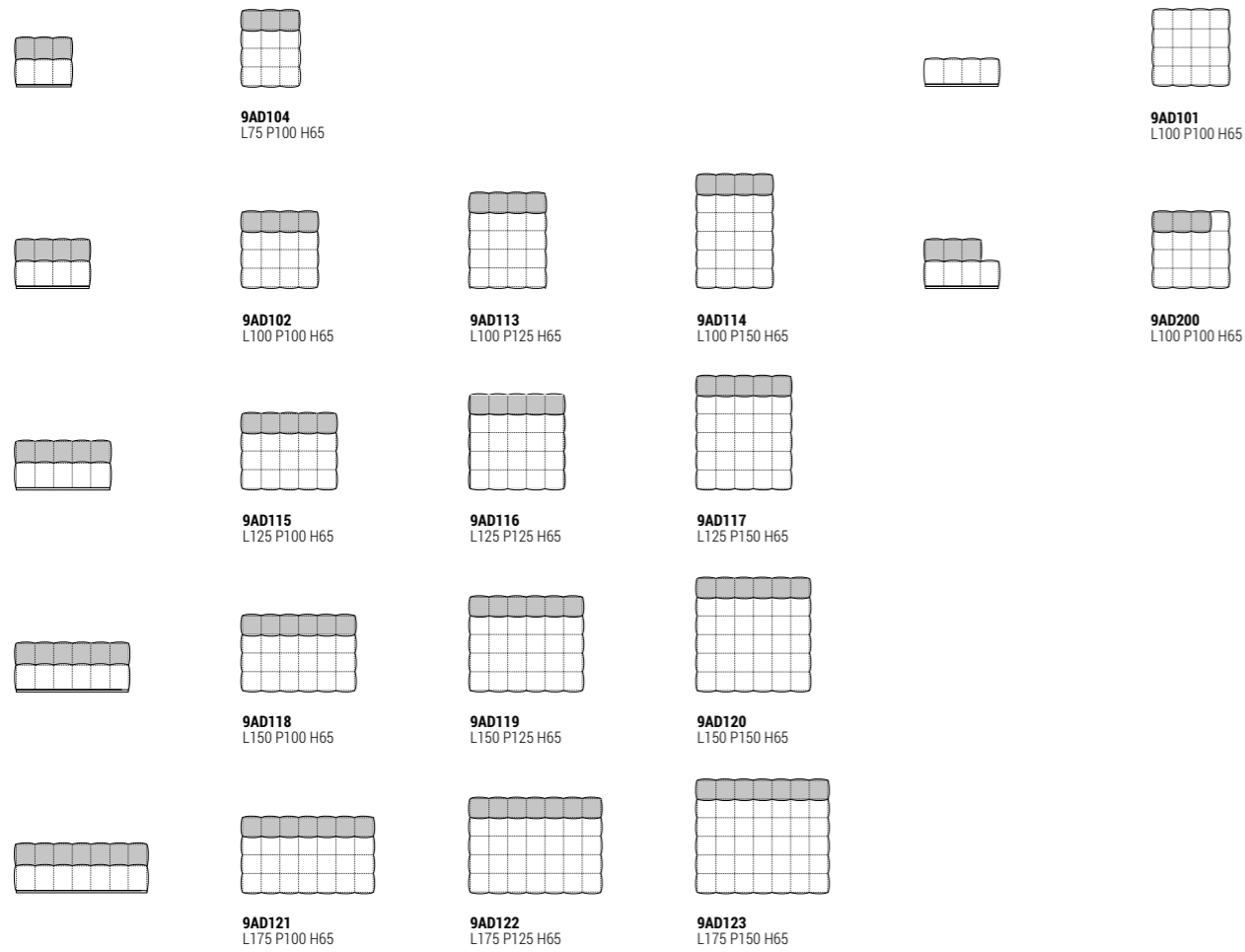

Pouf
Ottomans

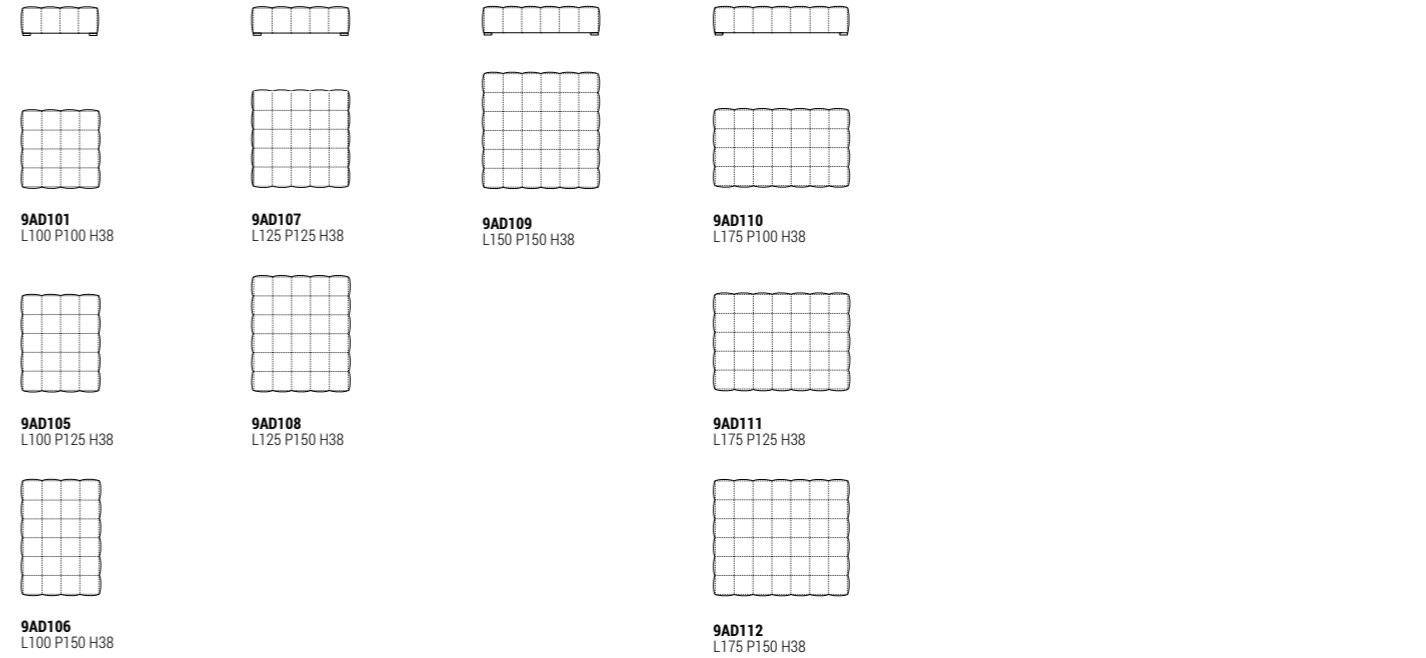

Dormeuse
Longchair

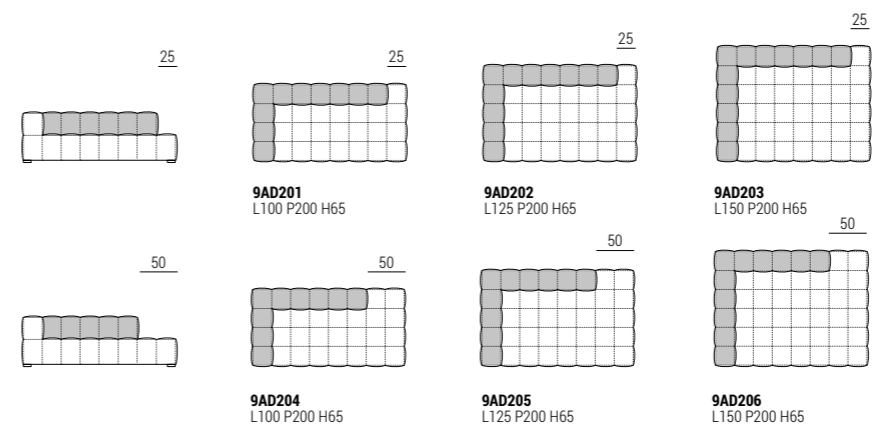

Atacama

DESIGN
MARCO CATTANEO
2020

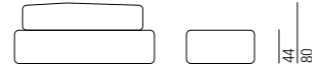

Fusto in legno massello e multistrato rivestito in poliuretano espanso a quote differenziate 30 kg/m³ e 40 kg/m³ e dacron.
Rivestimento fisso non sfoderabile.

Frame made of solid wood and multi-ply wood, upholstered with polyurethane foam in different densities of 30 kg/m³ and 40 kg/m³ and covered with dacron.
Fixed covers.

Das Gestell besteht aus Massiv- und Schichtholz, gepolstert mit Polyurethanschaumstoff in verschiedenen Dichten 30 Kg/m³ und 40 Kg/m³, mit Dacron ummantelt.
Atacama ist immer festbezogen.

Carcasse en bois massif et multiplis finie de mousse polyuréthane de différentes densités de 30 kg/m³ et 40 kg/m³, couverte de dacron.
Le revêtement est toujours fixe.

Каркас из массива дерева и фанеры покрыт пенополиуретаном различной плотности 30 кг / м³ и 40 кг / м³ и дакрон.
Неподвижная крышка не снимается.

Divani Sofas

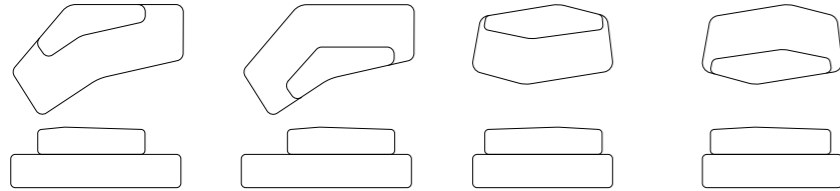

9ATC101
L225 P145 H80

9ATC102
L225 P145 H80

9ATC103
L185 P105 H80

9ATC104
L185 P105 H80

Pouf e accessori Ottomans and accessoires



9ATC105
L90 P70 H44

9ATC106
L85 P75 H44

9ATC107
L85 P75 H44
with glass top

9ATC108
L85 P75 H44
with marble top

9ATC109
L85 P75 H44
with wooden top

Atacama

DESIGN
MARCO CATTANEO
2020

Finiture Finishes

Top in etro
Glass top



RAL 9016
traffic white
back-painted glass
OPV3

RAL 9017
traffic black
back-painted glass
OPV4

RAL 7044
silk grey
back-painted glass
OPV5

RAL 1019
grey beige
back-painted glass
OPV6

Chrome
back-painted
bronze glass
OPV9

Chrome
back-painted
grey glass
OPV10

Top in marmo
Marble top



White Carrara
marble
OPP1

Black Marquinia
marble
OPP2

Brown
Emperador
marble
OPP3

Perfetto brown
marble
OPP10

Guatemala
green
marble
OPP12

Velvet brown
marble
OPP13

Top in legno
Wooden top



Cherry
stained oak
OPR1

Wengé
stained oak
OPR2

Walnut
stained oak
OPR3

Natural
oak
OPR4

Black
stained oak
OPR5

Cherry Milano
stained oak
OPR6

Code



Tobacco
stained oak
OPR8

Grey taupe
stained oak
OPR9

Whitened
oak
OPR10

Charcoal
stained oak
OPR11

Mahogany
stained oak
OPR12

Moka matt
stained oak
OPR15

Code

Break

DESIGN
STUDIO MARELLI
2009

Break

DESIGN
STUDIO MARELLI
2009

Tavoli Tables

40 28	60 28	80 35	90 35	
7BR101 Top marmo/Marble top 7BR104 Top MDF/MDF top 7BR111 Top legno/Wooden top 7BR117 Top vetro/Glass top 7BR114 Top metallo/Metal top ø40 H45	7BR102 Top marmo/Marble top 7BR105 Top MDF/MDF top 7BR112 Top legno/Wooden top 7BR118 Top vetro/Glass top 7BR115 Top metallo/Metal top ø60 H36	7BR103 Top marmo/Marble top 7BR106 Top MDF/MDF top 7BR113 Top legno/Wooden top 7BR119 Top vetro/Glass top 7BR116 Top metallo/Metal top ø80 H27	7BR120 Top marmo/Marble top 7BR121 Top MDF/MDF top 7BR122 Top legno/Wooden top 7BR123 Top vetro/Glass top 7BR124 Top metallo/Metal top L90 P60 H28	Top: marmo/rovere massello/MDF, spessore 20 mm Base: metallo, spessore 10 mm Top: marble/solid oak/MDF, 20 mm thick Base: metal, 10 mm thick

Finiture/Finishes

Top in marmo Marble top										
Code	White Carrara marble OPP1	Black Marquina marble OPP2	Brown Emperador marble OPP3	Calacatta gold marble OPP7	Perfetto brown marble OPP10	Grey Stone marble OPP11	Guatemala green marble OPP12	Velvet brown marble OPP13	Amani Bronze marble OPP14	Covelano white marble OPP15
Top in Gres Porcellanato Porcelain Stoneware Top										
Code	Carrara Pure OPG1	Nero Marquina OPG2	Statuario Select OPG3	Calacatta Royal OPG4						
Top in rovere massello Solid oak top										
Code	Cherry stained oak OPR1	Wengé stained oak OPR2	Walnut stained oak OPR3	Natural oak OPR4	Black stained oak OPR5	Cherry Milano stained oak OPR6				
Code	Tobacco stained oak OPR8	Grey taupe stained oak OPR9	Whitened oak OPR10	Charcoal stained oak OPR11	Mahogany stained oak OPR12	Moka matt stained oak OPR15	Anodyc Bronze metal OPM18			
Base/top in metallo Metal base/top										
Code	Shiny chrome metal OPM1	Brushed matt chrome metal OPM2	Brushed matt dark grey metal OPM3	RAL 9017 black painted metal OPM6	RAL 9016 white painted metal OPM7	Classic bronze painted metal OPM9	Golden beach painted metal OPM10	Gold pearl painted metal OPM11	Brushed copper metal OPM12	Brushed antique brass metal OPM13
Code	Shiny black chrome metal OPM14	Brushed antique gold metal OPM15	Shiny brass chrome metal OPM16	Bronze metal OPM17						
Top in MDF MDF top										
	RAL 9017 traffic black painted MDF	RAL 9016 traffic white painted MDF								

Chia

DESIGN
STEFANO GALLIZIOLI
2016

Struttura in tubolare di metallo ricoperto con schiuma di poliuretano a freddo ignifugo, classe 11M. Cuscino di seduta con struttura in Baydur® 80IK28/DO con imbottitura in poliuretano espanso con densità 40 kg/m³ (5,9 KPA), rivestito in fibra acrilica. Il rivestimento è sempre fisso. Il basamento girevole è in metallo a 4 razze. Basamento girevole in metallo disponibile in due versioni.

Structure en métal tubulaire recouvert de mousse à froid ignifuge classe 11M. Coussin d'assise avec structure en Baydur® 80IK28/DO, rembourré en mousse polyuréthane d'une densité de 40 kg/m³ (5,9 KPA), recouverte de fibre acrylique. Le revêtement est toujours fixe. Base pivotante en métal à 4 pieds. Base pivotante en métal disponible en deux versions.

Metal tube structure upholstered with cold injected fire retardant polyurethane foam class 11M. Seat cushion with structure in Baydur® 80IK28/DO upholstered with polyurethane foam with density of 40 kg/m³ (5,9 KPA), covered with acrylic fibre. Covers are always fixed. The metal swivel base is a 4-star base. Metal swivel base available in two versions.

Каркас из металлического профиля, покрытого слоем огнеупорного пенополиуретана холодного отверждения класса 11M. Подушка сиденья имеет основу из Baydur® 80IK28/DO и наполнение из вспененного полиуретана плотностью 40 кг/м³ (5,9 Кпа), обернутого в акриловое волокно. Обивка подушки несъемная. Вращающееся металлическое основание имеет 4 опоры.

Struktur der Sitzschale in Metall überschäumt mit Polyurethan-Kaltschaumstoff, Feuerwiderstandsklasse 11M. Sitzkissen mit Gestell in Baydur® 80IK28/DO, gepolstert mit Polyurethanschaumstoff mit Dichte 40 kg/m³ (5,9 KPA), mit Acrylfaser ummantelt. Bezüge immer fix, nicht abziehbar. Das Drehgestell ist in Metall, mit 4-Fusskreuz mit Standsäule. Das Drehgestell ist in Metall, in zwei Versionen erhältlich.

Baydur® - полимерный материал, производимый концерном Bayer. Металлическая поворотная основа доступна в двух версиях.

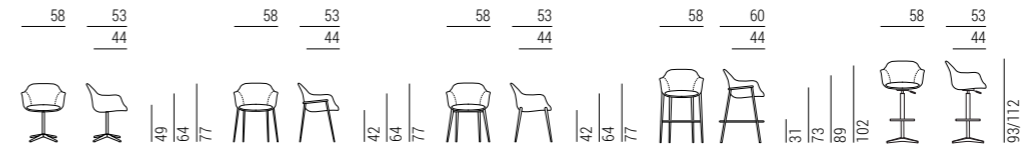

Chia

DESIGN
STEFANO GALLIZIOLI
2016

Poltrone Armchairs



9CHI103
L58 P53 H77
Poltroncina girevole con base in metallo
Swivel armchair with metal base



9CHI104
L58 P53 H77
Poltroncina con base in metallo
Armchair with metal base



9CHI105
L58 P53 H77
Poltroncina con base in legno
Armchair with wooden base



9CHI106
L58 P60 H102
Sgabello
Barstools



9CHI107
L58 P60 H93/112
Sgabello
Barstools

Basi girevoli Swivel bases

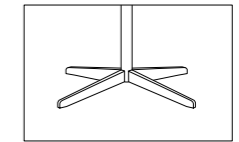

Versione A Base girevole in metallo a 4 razze
Version A Swivel 4-star metal base

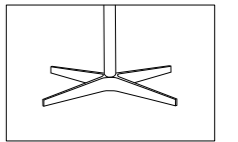

Versione B Base girevole in metallo a 4 razze
Version B Swivel 4-star metal base

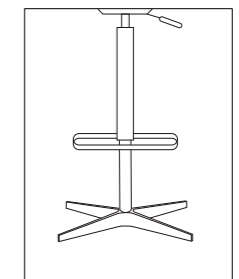

Versione C Base girevole in metallo a 4 razze
Version C Swivel 4-star metal base







Finiture Finishes







9CHI103 Base girevole in metallo A Swivel metal base A								
Code	Shiny chrome metal OPM1	Brushed matt chrome metal OPM2	Brushed matt dark grey metal OPM3	RAL 9017 black painted metal OPM6	RAL 9016 white painted metal OPM7	Classic bronze painted metal OPM9	Golden beach painted metal OPM10	
Code								
Code	Gold pearl painted metal OPM11	Brushed copper metal OPM12	Brushed antique brass metal OPM13	Shiny black chrome metal OPM14	Brushed antique gold metal OPM15	Shiny brass chrome metal OPM16	Bronze metal OPM17	Anodized Bronze painted metal OPM18
9CHI103 Base girevole in metallo B Swivel metal base B								
Code	Shiny chrome metal OPM1	Brushed matt chrome metal OPM2	RAL 9017 black painted metal OPM6	Classic bronze painted metal OPM9				

Finiture Finishes

9CHI104 9CHI106 base in metallo metal base										
Code	Brushed matt chrome metal OPM2	Brushed matt dark grey metal OPM3	RAL 9017 black painted metal OPM6	RAL 9016 white painted metal OPM7	Classic bronze painted metal OPM9	Golden beach painted metal OPM10	Gold pearl painted metal OPM11	Brushed copper metal OPM12	Brushed antique brass metal OPM13	Brushed antique gold metal OPM15
9CHI105 Base in legno Wooden base										
Code	Cherry stained oak OPR1	Wengé stained oak OPR2	Walnut stained oak OPR3	Natural oak OPR4	Black stained oak OPR5	Cherry Milano stained oak OPR6				
Code										
Code	Tobacco stained oak OPR8	Grey taupe stained oak OPR9	Whitened oak OPR10	Charcoal stained oak OPR11	Mahogany stained oak OPR12	Moka matt stained oak OPR15				

Tavoli
Tables

		
		
<p>7CL101 Tavolino in metallo verniciato <i>Painted metal table</i> 7CL107 Tavolino in metallo con top in vetro <i>Metal table with glass top</i> 7CL116 Tavolino in metallo cromato o spazzolato <i>Chrome/Brushed metal table</i> 7CL124 Tavolino in metallo con top in marmo <i>Metal table with marble top</i> Ø60 H27</p>	<p>7CL102 Tavolino in metallo verniciato <i>Painted metal table</i> 7CL108 Tavolino in metallo con top in vetro <i>Metal table with glass top</i> 7CL117 Tavolino in metallo cromato o spazzolato <i>Chrome/Brushed metal table</i> 7CL125 Tavolino in metallo con top in marmo <i>Metal table with marble top</i> Ø40 H40</p>	<p>7CL103 Tavolino in metallo verniciato <i>Painted metal table</i> 7CL109 Tavolino in metallo con top in vetro <i>Metal table with glass top</i> 7CL118 Tavolino in metallo cromato o spazzolato <i>Chrome/Brushed metal table</i> 7CL126 Tavolino in metallo con top in marmo <i>Metal table with marble top</i> Ø40 H50</p>

		
		
<p>7CL111 Tavolino in metallo verniciato <i>Painted metal table</i> 7CL121 Tavolino in metallo con top in vetro <i>Metal table with glass top</i> 7CL114 Tavolino in metallo cromato o spazzolato <i>Chrome/Brushed metal table</i> 7CL133 Tavolino in metallo con top in marmo <i>Metal table with marble top</i> Ø60 H40</p>	<p>7CL110 Tavolino in metallo verniciato <i>Painted metal table</i> * 7CL112 Tavolino in metallo con top in vetro <i>Metal table with glass top</i> * 7CL119 Tavolino in metallo cromato o spazzolato <i>Chrome/Brushed metal table</i> * 7CL127 Tavolino in metallo con top in marmo <i>Metal table with marble top</i> Ø100 H27</p>	<p>7CL113 Tavolino in metallo verniciato <i>Painted metal table</i> * 7CL115 Tavolino in metallo con top in vetro <i>Metal table with glass top</i> * 7CL120 Tavolino in metallo cromato o spazzolato <i>Chrome/Brushed metal table</i> * 7CL128 Tavolino in metallo con top in marmo <i>Metal table with marble top</i> Ø100 H40</p>

* Non realizzabili nelle finiture OPM1, OPM14, OPM16 e OPM17.
* Not available in the finishes OPM1, OPM14, OPM16 and OPM17.

Top: metallo, spessore 5 mm
Base: metallo, spessore 5 mm
Top: metal, 5 mm thick
Base: metal, 5 mm thick

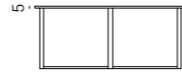



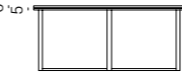



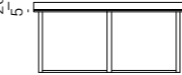



































Top: vetro extra light temperato, spessore 6 mm
Base: metallo spessore 5 mm
Top: extralight tempered glass, 6 mm thick
Base: metal, 5 mm thick



Top: marmo, spessore 20 mm
Base: metallo, spessore 5 mm
Top: marble, 20 mm thick
Base: metal, 5 mm thick



Finiture
Finishes

Base in metallo cromato o spazzolato <i>Chrome or brushed metal base</i>									
Code	Shiny chrome metal OPM1	Brushed matt chrome metal OPM2	Brushed matt dark grey metal OPM3	Brushed copper metal OPM12	Brushed antique brass metal OPM13	Shiny black chrome metal OPM14	Brushed antique gold metal OPM15	Shiny brass chrome metal OPM16	Bronze metal OPM17
Base in metallo verniciato <i>Painted metal base</i>									
Code	RAL 9017 black painted metal OPM6	RAL 9016 white painted metal OPM7	Metal painted in RAL Classic colors OPM8	Classic bronze painted metal OPM9	Golden beach painted metal OPM10	Gold pearl painted metal OPM11	Anodized Bronze metal OPM18		
Top in vetro <i>Glass top</i>									
Code	Transparent glass OPV1	Frosted glass OPV2	RAL 9016 traffic white back-painted glass OPV3	RAL 9017 traffic black back-painted glass OPV4	RAL 7044 silk grey back-painted glass OPV5	RAL 1019 grey beige back-painted glass OPV6			
									
Code	Glass back-painted in the RAL classic colours OPV7	Chrome back-painted bronze glass OPV9	Chrome back-painted grey glass OPV10	Transparent bronze glass OPV12	Transparent grey glass OPV13				
Top in marmo <i>Marble top</i>									
Code	White Carrara marble OPP1	Black Marquinia marble OPP2	Brown Emperador marble OPP3	Calacatta gold marble OPP7	Black and gold marble OPP9	Perfetto brown marble OPP10			
									
Code	Grey Stone marble OPP11	Guatemala green marble OPP12	Velvet brown marble OPP13	Amani Bronze marble OPP14	Covelano white marble OPP15				
Top in Gres Porcellanato <i>Porcelain Stoneware Top</i>									
Code	Carrara Pure OPG1	Nero Marquinia OPG2	Statuario Select OPG3	Calacatta Royal OPG4					

Clip Hexagonal

DESIGN
STUDIO MARELLI
2017

Clip Hexagonal

DESIGN
STUDIO MARELLI
2017

Tavoli
Tables



7CLX101
Tavolino in metallo
Metal table
Ø40 H50



7CLX102
Tavolino in metallo
con top in marmo
Metal table with marble top
Ø40 H50



7CLX103
Tavolino in metallo
Metal table
Ø40 H40



7CLX104
Tavolino in metallo
con top in marmo
Metal table with marble top
Ø40 H40

Top: metallo, spessore 5 mm
Base: metallo, spessore 5 mm
Top: metal, 5 mm thick
Base: metal, 5 mm thick



Top: marmo, spessore 20 mm
Base: metallo spessore 5 mm
Top: marble, 20 mm thick
Base: metal, 5 mm thick



Finiture
Finishes

Metallo cromato o spazzolato
Chrome or brushed metal



Shiny chrome metal OPM1	Brushed matt chrome metal OPM2	Brushed matt dark grey metal OPM3	Brushed copper metal OPM12	Brushed antique brass metal OPM13	Shiny black chrome metal OPM14	Brushed antique gold metal OPM15	Shiny brass chrome metal OPM16	Bronze metal OPM17	Anodized Bronze metal OPM18
-----------------------------------	--	---	--------------------------------------	---	--	--	--	------------------------------	---------------------------------------

Metallo verniciato
Painted metal



RAL 9017 black painted metal OPM6	RAL 9016 white painted metal OPM7	Classic bronze painted metal OPM9	Golden beach painted metal OPM10	Gold pearl painted metal OPM11
---	---	---	--	--

Top in marmo
Marble top



White Carrara marble OPP1	Black Marquinia marble OPP2	Brown Emperador marble OPP3	Calacatta gold marble OPP7	Black and gold marble OPP9	Perfetto brown marble OPP10
-------------------------------------	---------------------------------------	---------------------------------------	--------------------------------------	--------------------------------------	---------------------------------------



Grey Stone marble OPP11	Guatemala green marble OPP12	Velvet brown marble OPP13	Amani Bronze marble OPP14	Covelano white marble OPP15
-----------------------------------	--	-------------------------------------	-------------------------------------	---------------------------------------

Top in Gres Porcellanato
Porcelain Stoneware Top

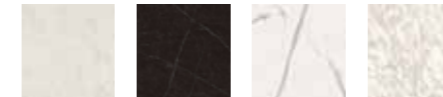

Carrara Pure OPG1	Nero Marquinia OPG2	Statuario Select OPG3	Calacatta Royal OPG4
-----------------------------	-------------------------------	---------------------------------	--------------------------------

Clipper

DESIGN
STEFANO GALLIZIOLI
2019

Schienale in legno multistrato di pioppo curvato imbottito con poliuretano espanso con densità 30 kg/m³. Seduta in legno multistrato di pioppo imbottito con poliuretano espanso con densità 40 kg/m³, rivestito in dacron con cinghie elastiche intrecciate. Rivestimento fisso.
Il modello è disponibile senza piedini, con basamento in legno o in metallo. Le poltrone sono disponibili anche con basamento girevole in metallo.

*Dossier en bois multiplis de peuplier courbé fini de mousse de polyuréthane de densité de 30 kg/m³. Structure d'assise en bois multiplis de peuplier finie de mousse de polyuréthane de densité de 40 kg/m³ couverte de dacron, muni de bandes élastiques entrecroisées.
Le revêtement est toujours fixe.
Le modèle est disponible sans piètement, avec piètement en bois ou en métal. Les fauteuils sont disponibles aussi avec base pivotante en métal.*

*Backrest made of curved multi-ply poplar wood, upholstered with polyurethane foam with density 30 kg/m³. Seat structure made of multi-ply poplar wood, upholstered with polyurethane foam with density 40 kg/m³, covered with dacron, with interwoven elastic belts. Fixed covers.
The model is available without base, with wooden or metal base. The armchairs are also available also with swivel metal base.*

*Спинка: гнутая многослойная фанера из тополя в сочетании со вспененным полиуретаном плотностью 30кг/м³. Сиденье: гнутая многослойная фанера из тополя в сочетании со вспененным полиуретаном плотностью 40кг/м³, обернутым в дакрон. Подвеска из перекрещивающихся эластичных ремней. Обивка съёмная.
Помимо ножек диван может иметь деревянное либо металлическое основание. Кресла могут иметь поворотное металлическое основание.*

*Rückenlehne aus gebogenem Pappelschichtholz, gepolstert mit Polyurethan-Schaumstoff mit Dichte 30 Kg/m³. Sitzstruktur aus Pappelschichtholz, gepolstert mit Polyurethan-Schaumstoff mit Dichte 40 Kg/m³, mit Dacron Ummantelt, mit gefrochtenen Gummigurten. Clipper ist immer festbezogen.
Das Modell ist ohne Fussgestell, mit Fussgestell in Holz oder Metall erhältlich. Die Sessel sind auch mit Drehgestell in Metall lieferbar.*

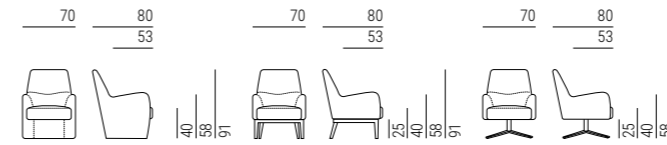

Poltrone e divani Armchairs and Sofas

Schienale alto
High back



9CLX101
L70 P80 H91



9CLX102
L70 P80 H91
Base in legno
Wooden base



9CLX103
L70 P80 H91
Base in metallo
Metal base



9CLX104
L70 P80 H91
Base metallo girevole
Metal swivel base

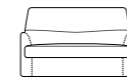

9CLX201
L150 P80 H91

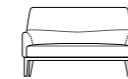

9CLX203
L150 P80 H91
Base in legno
Wooden base

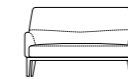

9CLX205
L150 P80 H91
Base in metallo
Metal base

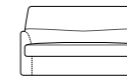

9CLX202
L170 P80 H91

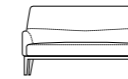

9CLX204
L170 P80 H91
Base in legno
Wooden base

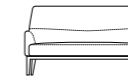

9CLX206
L170 P80 H91
Base in metallo
Metal base

Finiture Finishes

Base legno
Wooden base



Code Cherry stained oak **OPR1** Wengé stained oak **OPR2** Walnut stained oak **OPR3** Natural oak **OPR4** Black stained oak **OPR5** Cherry Milano stained oak **OPR6**



Code Tobacco stained oak **OPR8** Grey taupe stained oak **OPR9** Whitened oak **OPR10** Charcoal stained oak **OPR11** Mahogany stained oak **OPR12** Moka matt stained oak **OPR15**

Base metallo
Metal base



Code Shiny chrome metal **OPM1** Brushed matt chrome metal **OPM2** Brushed matt dark grey metal **OPM3** RAL 9017 black painted metal **OPM6** RAL 9016 white painted metal **OPM7** Classic bronze painted metal **OPM9**



Code Golden beach painted metal **OPM10** Gold pearl painted metal **OPM11** Brushed antique copper metal **OPM12** Brushed antique brass metal **OPM13** Shiny black chrome metal **OPM14** Brushed antique gold metal **OPM15** Shiny brass chrome metal **OPM16** Bronze metal **OPM17** Anodyc Bronze painted metal **OPM18**

Clipper

DESIGN
STEFANO GALLIZIOLI
2019

Clipper

DESIGN
STEFANO GALLIZIOLI
2019

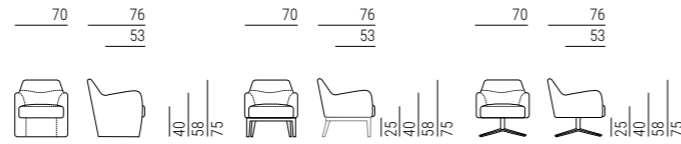

Poltrone e divani Armchairs and Sofas

Schienale basso
Low back

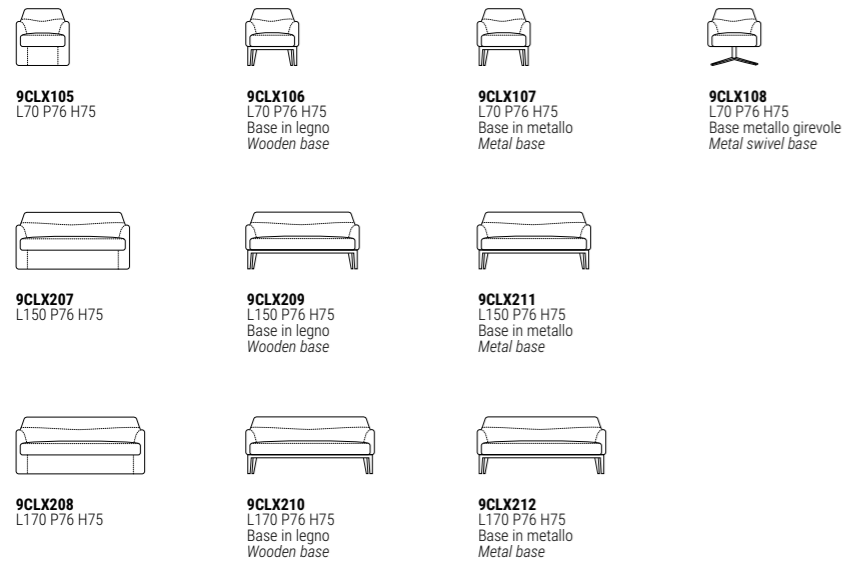

Finiture Finishes

Base legno
Wooden base



Code

Cherry stained oak OPR1	Wengé stained oak OPR2	Walnut stained oak OPR3	Natural oak OPR4	Black stained oak OPR5	Cherry Milano stained oak OPR6
-----------------------------------	----------------------------------	-----------------------------------	----------------------------	----------------------------------	--



Code

Tobacco stained oak OPR8	Grey taupe stained oak OPR9	Whitened oak OPR10	Charcoal stained oak OPR11	Mahogany stained oak OPR12	Moka matt stained oak OPR15
------------------------------------	---------------------------------------	------------------------------	--------------------------------------	--------------------------------------	---------------------------------------

Base metallo
Metal base



Code

Shiny chrome metal OPM1	Brushed matt chrome metal OPM2	Brushed matt dark grey metal OPM3	RAL 9017 black painted metal OPM6	RAL 9016 white painted metal OPM7	Classic bronze painted metal OPM9
-----------------------------------	--	---	---	---	---



Code

Golden beach painted metal OPM10	Gold pearl painted metal OPM11	Brushed copper metal OPM12	Brushed antique brass metal OPM13	Shiny black chrome metal OPM14	Brushed antique gold metal OPM15	Shiny brass chrome metal OPM16	Bronze metal OPM17	Anodized Bronze painted metal OPM18
--	--	--------------------------------------	---	--	--	--	------------------------------	---

Clipper

DESIGN
STEFANO GALLIZIOLI
2019

Fusto in legno massello e legno multistrato con cinghie elastiche intrecciate. Imbottitura in poliuretano espanso rivestito in vellutino bianco. Cuscini di schienale in Piumafib, una speciale miscela ipoallergenica di vera piuma e fibra poliestere siliconata*. Cuscini di seduta costituiti da un inserto in poliuretano con densità di 30 Kg/m³ ricoperto da un trapuntino di vera piuma imbottito a scomparti*. Completamente sfoderabile in tessuto, non sfoderabile in pelle e finta pelle.
Kit letto non disponibile.
*Manutenzione dei cuscini contenenti piuma: I cuscini contenenti piuma tendono a deformarsi con l'utilizzo. Per mantenerne la forma è necessario, anche dopo un breve utilizzo, battere e sprimacciare ripetutamente i cuscini. Non utilizzare mai battipanni o aspirapolvere. A coloro che non desiderassero seguire queste indicazioni o che volessero un divano dall'aspetto meno vissuto, raccomandiamo di preferire dei cuscini in gomma.

Carcasse en bois massif et multiplis muni de bandes élastiques entrecroisées et finie de mousse polyuréthane couverte de dacron. Coussins de dossier en Piumafib, un mélange hypoallergénique spécial de véritable duvet et fibre polyester siliconisée. Les coussins d'assise sont composés d'un noyau en mousse polyuréthane d'une densité de 30 kg/m³ couvert de véritable duvet broché en compartiments*. Revêtement complètement déhoussable en tissu, fixe en cuir et cuir look. Pas disponible en canapé-lit.
Entretien de coussins en duvet: Coussins en duvet ont tendance à perdre leur forme dû à l'usage. Pour en conserver la forme il est nécessaire, aussi après un usage court, de régulièrement battre les coussins. Ne jamais utiliser la tapette ou l'aspirateur. A ceux qui ne désirent pas suivre ces indications ou qui souhaitent un canapé qui ait l'air moins "usé", nous conseillons vivement de choisir des coussins en mousse polyuréthane.

Frame made of solid wood and multi-ply wood with interwoven elastic straps. The upholstery is made of polyurethane foam, covered with dacron. The back cushions are filled with Piumafib, a special hypoallergenic mixture of feathers and siliconised polyfibre*. The seat cushions are made of a foam insert with density of 30 Kg/m³, covered with a feather compartments quilt*. Fully removable fabric covers, fixed leather and artificial leather covers. Sofa-bed is not available.
*Maintenance of feather cushions: Cushions filled with feathers tend to change their shape with use. In order to keep their shape it is necessary, even after a short use, to plump up the cushions repeatedly. Never use carpet beater or vacuum cleaner. We recommend to choose foam cushions to those who do not wish to follow these instructions or to have a "used look" sofa.

Для производства каркаса используется массив дерева и многослойная фанера в сочетании с перекрещивающимися эластичными ремнями. Наполнение из полиуретана, обернутого в белый бархат. Наполнение подушек спинки выполнено из материала Piumafib – специальной, не вызывающей аллергию смеси из натурального пуха и полиэфирных силиконовых волокон*. Подушки сиденья: стеганые по отсекам, наполнение из натурального пуха с вставками из полиуретана плотностью 30 кг/м³ *. Полностью съемные чехлы из ткани, несъемные чехлы из кожи.

Das Gestell besteht aus Massiv- und Schichtholz, mit geflochtenen Gummigurten, gepolstert mit Polyurethanschaumstoff, mit Dacron bezogen. Rueckenkissen aus Piumafib, einer hypoallergischen speziellen Mischung aus echter Daune und silikonisierter Polyesterfaser*. Die Sitzkissen bestehen aus einem Schaumkern mit Dichte 30 Kg/m³ mit einer gekammerten Daunenaufgabe*. Stoffbezüge alle abziehbar, Leder und Kunstleder festbezogen. Als Bettsofa nicht verfügbar. Wartungsanleitungen fuer Daunenkissen: Die Kissen, die Daunen enthalten, neigen dazu, sich durch Gebrauch zu verformen. Um die urspruengliche Form zu halten, ist es notwendig, auch nach kurzem Gebrauch, die Kissen wiederholt aufzuschuettern. Keinen Ausklopfen oder Staubsauger verwenden. Unseren Kunden, die diese Anweisungen nicht befolgen moechten, oder die kein Sofa mit solchem "gebrauchten" Aussehen haben moechten, empfehlen wir Polyurethan-Kissen.

Вариант со спальным местом не предусмотрен. *Эксплуатация подушек с пуховым наполнением: В процессе эксплуатации подушки с пуховым наполнением могут деформироваться, во избежание чего их необходимо слегка взбивать вручную даже после непродолжительного нахождения на диване. Использование в этих целях пылесоса или выбивалки для одежды категорически запрещено. Если клиент не планирует следовать данным инструкциям и хочет, чтобы подушки сиденья и спинки проминались по минимуму, посоветуйте выбрать наполнение только из полиуретана, полностью исключив натуральный пух.

Clipper

DESIGN
STEFANO GALLIZIOLI
2019

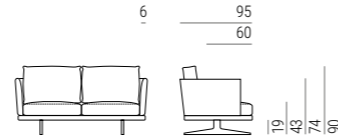

Divani
Sofas

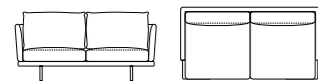

9CLP201
L184 P95 H90

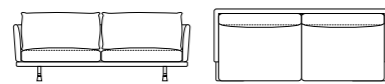

9CLP202
L224 P95 H90

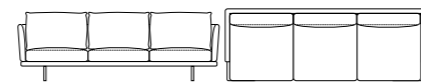

9CLP203
L264 P95 H90

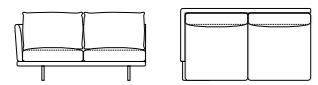

9CLP204
L172 P95 H90

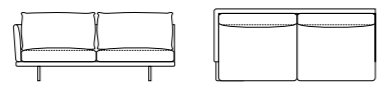

9CLP205
L212 P95 H90

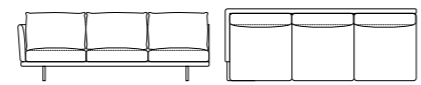

9CLP206
L252 P95 H90

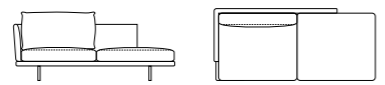

9CLP207
L212 P95 H90

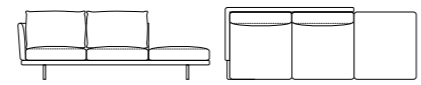

9CLP208
L252 P95 H90



9CLP210
L212 P95 H90

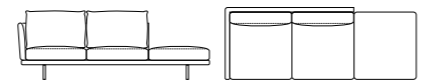

9CLP211
L252 P95 H90

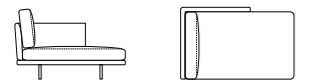

9CLP209
L144 P95 H90

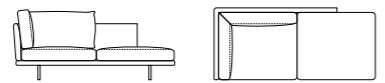

9CLP212
L212 P95 H90

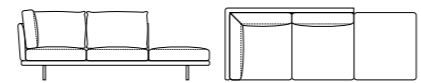

9CLP213
L252 P95 H90

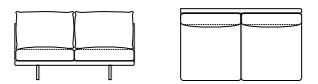

9CLP214
L160 P95 H90

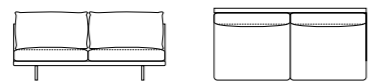

9CLP215
L200 P95 H90

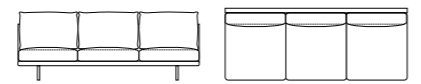

9CLP216
L240 P95 H90

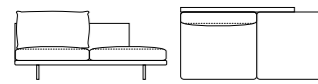

9CLP217
L200 P95 H90

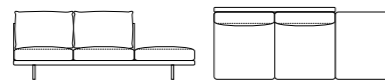

9CLP218
L240 P95 H90

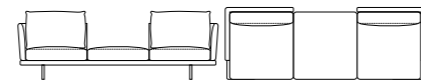

9CLP219
L264 P95 H90

Clipper

DESIGN
STEFANO GALLIZIOLI
2019

Accessori
Accessories

Cuscinetto in piuma
senza fascia
Feather cushion
without band



9CU103
L40 H40

Cuscino in piuma
senza fascia
Feather back cushion
without band



9CU106
L45 P45

Cuscinetto in piuma
senza fascia
Feather cushion
without band



9CUT103
L40 H40

Cuscino in piuma
senza fascia
Feather back cushion
without band



9CUT106
L45 P45

Piedini
Feet

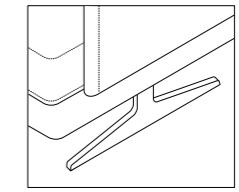

Versione A (standard)
in metallo
Version A (standard)
in metal

H 19 cm

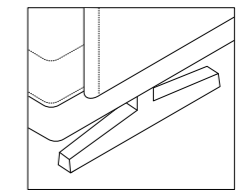

Versione B (optional)
in rovere
Version B (optional)
in oak

H 19 cm

Finiture
Finishes

Base legno
Wooden base

Code



Cherry stained oak **OPR1** Wengé stained oak **OPR2** Walnut stained oak **OPR3** Natural oak **OPR4** Black stained oak **OPR5** Cherry Milano stained oak **OPR6**

Code



Tobacco stained oak **OPR8** Grey taupe stained oak **OPR9** Whitened oak **OPR10** Charcoal stained oak **OPR11** Mahogany stained oak **OPR12** Moka matt stained oak **OPR15**

Base metallo
Metal base

Code



Shiny chrome metal **OPM1** Brushed matt chrome metal **OPM2** Brushed matt dark grey metal **OPM3** RAL 9017 black painted metal **OPM6** RAL 9016 white painted metal **OPM7** Classic bronze painted metal **OPM9**

Code



Golden beach painted metal **OPM10** Gold pearl painted metal **OPM11** Brushed copper metal **OPM12** Brushed antique brass metal **OPM13** Brushed antique gold metal **OPM15** Anodyc Bronze painted metal **OPM18**

Derek

DESIGN
STUDIO MARELLI
2019

Schienale in legno multistrato di pioppo curvato imbottito con poliuretano espanso a quote differenziate con densità 30 kg/m³ e 40 kg/m³.
Seduta in legno multistrato di pioppo imbottito con poliuretano espanso a quote differenziate con densità 30 kg/m³ e 40 kg/m³, rivestito in dacron con cinghie elastiche intrecciate.
Rivestimento fisso.
Basamento disponibile in metallo o faggioio.

*Dossier en bois multiplis de peuplier courbé fini de mousse de polyuréthane de différentes densités de 30 kg/m³ et 40 kg/m³.
Structure de l'assise en bois multiplis de peuplier fini de mousse de polyuréthane de différentes densités de 30 kg/m³ et 40 kg/m³ couverte de dacron, muni de bandes élastiques entrecroisées.
Revêtement fixe.
Piètement disponible en métal ou en hêtre.*

*Backrest made of curved multi-ply poplar wood, upholstered with polyurethane foam in different densities of 30 kg/m³ and 40 kg/m³.
Seat structure made of multi-ply poplar wood, upholstered with polyurethane foam in different densities of 30 kg/m³ and 40 kg/m³, covered with dacron, with interwoven elastic belts.
Fixed covers.
The base is available in metal or beech.*

*Спинка кресла: гнутая многослойная фанера из тополя, покрытая вспененным полиуретаном различной степени плотности 30 и 40 кг/м³.
Сиденье: многослойная фанера из тополя, покрытая вспененным полиуретаном различной степени плотности 30 и 40 кг/м³ в чехле из дакрона, подвеска из перекрещивающихся эластичных ремней.
Чехлы несъемные.
Основание: металл /дерево (бук)*

*Rückenlehne aus gebogenem Pappelschichtholz, gepolstert mit Polyurethan-Schaumstoff in verschiedenen Dichten von 30 Kg/m³ und 40 Kg/m³.
Sitzstruktur aus Pappelschichtholz, gepolstert mit Polyurethan-Schaumstoff in verschiedenen Dichten von 30 kg/m³ und 40 Kg/m³, mit Dacron ummantelt, mit geflochtenen Gummigurten.
Derek ist immer festbezogen.
Das Untergestell ist in Metall oder in Buchenholz verfügbar.*

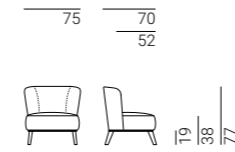

Divani Sofas



9DK101
Poltrona
Armchair
L75 P70 H77

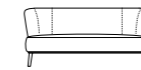

9DK201
Divano
Sofa
L168 P70 H77

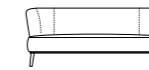

9DK202
Divano
Sofa
L188 P70 H77

Finiture Finishes

Base in metallo Metal base



Code Shiny chrome metal **OPM1** Brushed matt chrome metal **OPM2** Brushed matt dark grey metal **OPM3** RAL 9017 black painted metal **OPM6** RAL 9016 white painted metal **OPM7** Classic bronze painted metal **OPM9** Golden beach painted metal **OPM10** Gold pearl painted metal **OPM11**

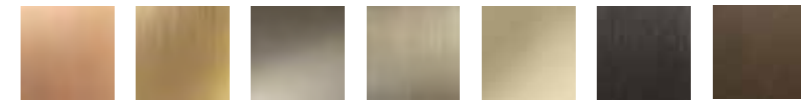

Code Brushed copper metal **OPM12** Brushed antique brass metal **OPM13** Shiny black chrome metal **OPM14** Brushed antique gold metal **OPM15** Shiny brass chrome metal **OPM16** Bronze metal **OPM17** Anodyc Bronze painted metal **OPM18**

Base in legno Wooden base



Code Cherry stained oak **OPR1** Wengé stained oak **OPR2** Walnut stained oak **OPR3** Natural oak **OPR4** Black stained oak **OPR5** Cherry Milano stained oak **OPR6**



Code Tobacco stained oak **OPR8** Grey taupe stained oak **OPR9** Whitened oak **OPR10** Charcoal stained oak **OPR11** Mahogany stained oak **OPR12** Moka matt stained oak **OPR15**

Derek

DESIGN
STUDIO MARELLI
2019

Dune

DESIGN
STUDIO MARELLI
2020

Tavoli
Tables



7DU101
Ø40 H42
con top marmo
with marble top
7DU111
Ø40 H42
con top vetro
with glass top



7DU102
Ø40 H52
con top marmo
with marble top
7DU112
Ø40 H542
con top vetro
with glass top

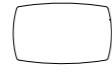

7DU103
L130 P80 H37
con top marmo
with marble top
7DU113
L130 P80 H37
con top vetro
with glass top



7DU104
L120 P80 H37
con top marmo
with marble top
7DU114
L120 P80 H37
con top vetro
with glass top



7DU105
L90 P90 H37
con top marmo
with marble top
7DU115
L90 P90 H37
con top vetro
with glass top

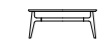
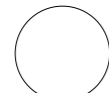

7DU106
Ø125 H37
con top marmo
with marble top
7DU116
Ø125 H37
con top vetro
with glass top



7DU107
L100 P100 H37
con top marmo
with marble top
7DU117
L100 P100 H37
con top vetro
with glass top



7DU108
Ø80 H37
con top marmo
with marble top
7DU118
Ø80 H37
con top vetro
with glass top

Dune

DESIGN
STUDIO MARELLI
2020

Finiture
Finishes

Top/base in legno
Wooden base/top



Code
Cherry stained oak **OPR1** | Wengé stained oak **OPR2** | Walnut stained oak **OPR3** | Natural oak **OPR4** | Black stained oak **OPR5** | Cherry Milano stained oak **OPR6**



Code
Tobacco stained oak **OPR8** | Grey taupe stained oak **OPR9** | Whitened oak **OPR10** | Charcoal stained oak **OPR11** | Mahogany stained oak **OPR12** | Moka matt stained oak **OPR15**

Top in marmo
Marble top

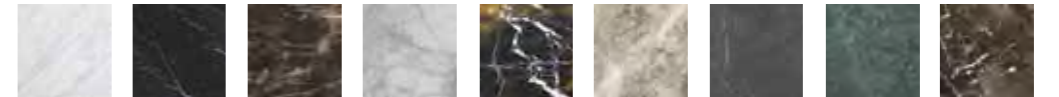

Code
White Carrara marble **OPP1** | Black Marquina marble **OPP2** | Brown Emperador marble **OPP3** | Calacatta gold marble **OPP7** | Black and gold marble **OPP9** | Peretto brown marble **OPP10** | Grey Stone marble **OPP11** | Guatemala green marble **OPP12** | Velvet brown marble **OPP13**



Code
Amani Bronze marble **OPP14** | Covellano white marble **OPP15**

Top in Gres Porcellanato
Porcelain Stoneware Top



Code
Carrara Pure **OPG1** | Nero Marquina **OPG2** | Statuario Select **OPG3** | Calacatta Royal **OPG4**

Top in vetro
Glass top



Code
Transparent glass **OPV1** | Frosted glass **OPV2** | RAL 9016 traffic white back-painted glass **OPV3** | RAL 9017 traffic black back-painted glass **OPV4** | RAL 7044 silk grey back-painted glass **OPV5** | RAL 1019 grey beige back-painted glass **OPV6** | Chrome back-painted bronze glass **OPV9** | Chrome back-painted grey glass **OPV10** | Transparent bronze glass **OPV12** | Transparent grey glass **OPV13**

Tavoli
Tables

Tavolini con piano rotondo
Coffee tables with round top

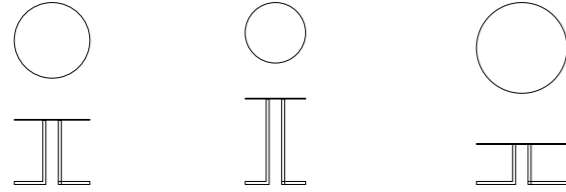

7EL101
Tavolino in metallo
Metal coffee table
7EL201
Top marmo/Marble top
Ø50 H43

7EL103
Tavolino in metallo
Metal coffee table
7EL202
Top marmo/Marble top
Ø40 H57

7EL105
Tavolino in metallo
Metal coffee table
7EL203
Top marmo/Marble top
Ø60 H27

Top: metallo, spessore 5 mm
Base: tubo di metallo quadrato,
sezione 15 mm
Top: metal, 5 mm thick
Base: square metal tube,
section 15 mm

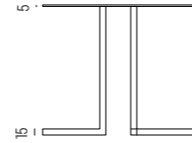

Tavolini con piano quadrato
e angoli arrotondati
Coffee tables with square top
with rounded edges

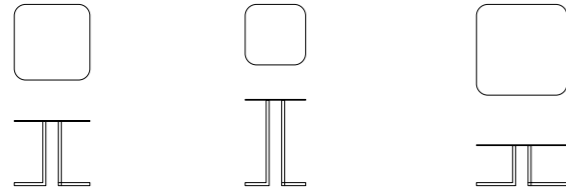

7EL107
Tavolino in metallo
Metal coffee table
7EL204
Top marmo/Marble top
L50 P50 H43

7EL108
Tavolino in metallo
Metal coffee table
7EL205
Top marmo/Marble top
L40 P40 H57

7EL109
Tavolino in metallo
Metal coffee table
7EL206
Top marmo/Marble top
L60 P60 H27

Tavolini con piano quadrato
Coffee tables with square top

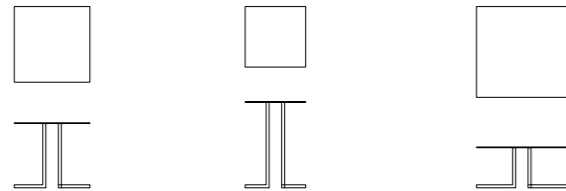

7EL110
Tavolino in metallo
Metal coffee table
7EL207
Top marmo/Marble top
L50 P50 H43

7EL111
Tavolino in metallo
Metal coffee table
7EL208
Top marmo/Marble top
L40 P40 H57

7EL112
Tavolino in metallo
Metal coffee table
7EL209
Top marmo/Marble top
L60 P60 H27

Finiture
Finishes

Metallo verniciato
Painted metal



Code
RAL 9017 black painted metal **OPM6**
RAL 9016 white painted metal **OPM7**
Metal painted in RAL Classic colors **OPM8**
Classic bronze painted metal **OPM9**
Golden beach painted metal **OPM10**
Gold pearl painted metal **OPM11**
Anodized Bronze metal **OPM18**

Metallo cromato o spazzolato
Chrome or brushed metal



Code
Shiny chrome metal **OPM1**
Brushed matt chrome metal **OPM2**
Brushed matt dark grey metal **OPM3**
Brushed copper metal **OPM12**
Brushed antique brass metal **OPM13**
Shiny black chrome metal **OPM14**
Brushed antique gold metal **OPM15**
Shiny brass chrome metal **OPM16**
Bronze metal **OPM17**

Top in marmo
Marble top

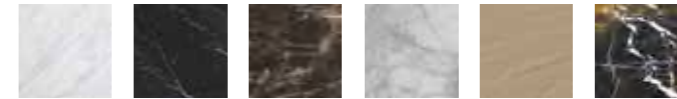

Code
White Carrara marble **OPP1**
Black Marquina marble **OPP2**
Brown Emperador marble **OPP3**
Calacatta gold marble **OPP7**
Brown Santafiora stone **OPP8**
Black and gold marble **OPP9**

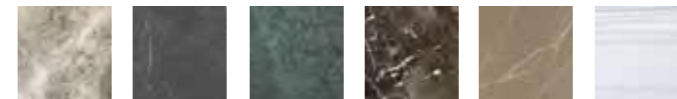

Code
Perfetto brown marble **OPP10**
Grey Stone marble **OPP11**
Guatemala green marble **OPP12**
Velvet brown marble **OPP13**
Amani Bronze marble **OPP14**
Covelano white marble **OPP15**

Top in Gres Porcellanato
Porcelain Stoneware Top

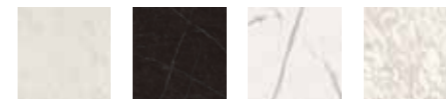







Code
Carrara Pure **OPG1**
Nero Marquina **OPG2**
Statuario Select **OPG3**
Calacatta Royal **OPG4**

Frame

DESIGN
STUDIO MARELLI
2009







Tavoli
Tables

					
7FR101 Top in vetro/Glass top 7FR111 Top in legno/Wooden top 7FR123 Top in marmo/Marble top L70 P70 H28	7FR102 Top in vetro/Glass top 7FR112 Top in legno/Wooden top 7FR124 Top in marmo/Marble top L120 P70 H28	7FR103 Top in vetro/Glass top 7FR113 Top in legno/Wooden top 7FR125 Top in marmo/Marble top L100 P100 H28	7FR131 Top in vetro/Glass top 7FR136 Top in legno/Wooden top 7FR139 Top in marmo/Marble top L70 P70 H40	7FR132 Top in vetro/Glass top 7FR137 Top in legno/Wooden top 7FR140 Top in marmo/Marble top L120 P70 H40	7FR133 Top in vetro/Glass top 7FR138 Top in legno/Wooden top 7FR141 Top in marmo/Marble top L100 P100 H40
					
7FR104 Top in vetro/Glass top 7FR147 Top in legno/Wooden top 7FR121 Top in marmo/Marble top Ø100 H28	7FR105 Top in vetro/Glass top 7FR148 Top in legno/Wooden top 7FR122 Top in marmo/Marble top Ø120 H28	7FR134 Top in vetro/Glass top 7FR149 Top in legno/Wooden top 7FR142 Top in marmo/Marble top Ø100 H40	7FR135 Top in vetro/Glass top 7FR150 Top in legno/Wooden top 7FR143 Top in marmo/Marble top Ø120 H40	7FR151 Top in vetro/Glass top 7FR152 Top in legno/Wooden top 7FR153 Top in marmo/Marble top L50 P50 H50	7FR106 Top in vetro/Glass top 7FR116 Top in legno/Wooden top 7FR126 Top in marmo/Marble top L35 P35 H52
					
7FR162 Top in legno/Wooden top 7FR163 Top in marmo/Marble top 7FR164 Top in vetro/Glass top Ø40 H40	7FR165 Top in legno/Wooden top 7FR166 Top in marmo/Marble top 7FR167 Top in vetro/Glass top Ø40 H50	7FR168 Top in legno/Wooden top 7FR169 Top in marmo/Marble top 7FR170 Top in vetro/Glass top Ø60 H40	7FR171 Top in legno/Wooden top 7FR172 Top in marmo/Marble top 7FR173 Top in vetro/Glass top Ø80 H40		

Frame

DESIGN
STUDIO MARELLI
2009

Tavoli
Tables

				
7FR108 Top in vetro/Glass tops 7FR118 Top in legno/Wooden tops 7FR129 Top in marmo/Marble tops 7FR157 Top in metallo/Metal tops L160 P40 H70	7FR109 Top in vetro/Glass tops 7FR119 Top in legno/Wooden tops 7FR130 Top in marmo/Marble tops 7FR158 Top in metallo/Metal tops L200 P40 H70	7FR110 Top in vetro/Glass top 7FR120 Top in legno/Wooden top 7FR127 Top in marmo/Marble top 7FR159 Top in metallo/Metal top L55 P27 H51,5	7FR144 Top in vetro/Glass top 7FR145 Top in legno/Wooden top 7FR146 Top in marmo/Marble top 7FR160 Top in metallo/Metal top L55 P40 H51,5	7FR144 Top in vetro/Glass top 7FR145 Top in legno/Wooden top 7FR146 Top in marmo/Marble top 7FR160 Top in metallo/Metal top L55 P40 H51,5
				
				

Top: vetro extra light temperato o specchio, spessore 6 mm
Base: tubo di metallo quadrato, sezione 15 mm
Top: extralight tempered glass or mirror, 6 mm thick
Base: square metal tube, section 15 mm

Top: rovere impiallacciato, spessore 30 mm
Base: tubo di metallo quadrato, sezione 15 mm
Top: oak veneer, 30 mm thick
Base: square metal tube, section 15 mm

Top: marmo, spessore 20 mm
Base: tubo di metallo quadrato, sezione 15 mm
Top: marble, 20 mm thick
Base: square metal tube, section 15 mm



































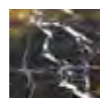

Frame

DESIGN
STUDIO MARELLI
2009





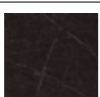







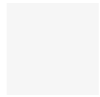





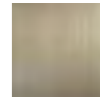



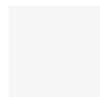

Frame

DESIGN
STUDIO MARELLI
2009

Finiture Finishes

Top in vetro Glass top										
Code	Transparent glass OPV1	Frosted glass OPV2	RAL 9016 traffic white back-painted glass OPV3	RAL 9017 traffic black back-painted glass OPV4	RAL 7044 silk grey back-painted glass OPV5	RAL 1019 grey beige back-painted glass OPV6	Chrome back-painted bronze glass OPV9	Chrome back-painted grey glass OPV10	Transparent bronze glass OPV12	Transparent grey glass OPV13
Top in legno Wooden top										
Code	Cherry stained oak OPR1	Wengé stained oak OPR2	Walnut stained oak OPR3	Natural oak OPR4	Black stained oak OPR5	Cherry Milano stained oak OPR6	Tobacco stained oak OPR8			
										
Code	Grey taupe stained oak OPR9	Whitened oak OPR10	Charcoal stained oak OPR11	Mahogany stained oak OPR12	Moka matt stained oak OPR15					
Top in marmo Marble top										
Code	White Carrara marble OPP1	Black Marquinia marble OPP2	Brown Emperador marble OPP3	Calacatta gold marble OPP7	Black and gold marble OPP9	Perfetto brown marble OPP10				
										
Code	Grey Stone marble OPP11	Guatemala green marble OPP12	Velvet brown marble OPP13	Amani Bronze marble OPP14	Covelano white marble OPP15					
Top in Gres Porcellanato Porcelain Stoneware Top										
Code	Carrara Pure OPG1	Nero Marquinia OPG2	Statuario Select OPG3	Calacatta Royal OPG4						

Finiture Finishes

Top in metallo Metal top										
Code	Brushed matt dark grey metal OPM3	RAL 9017 black painted metal OPM6	RAL 9016 white painted metal OPM7	Classic bronze painted metal OPM9	Golden beach painted metal OPM10	Gold pearl painted metal OPM11	Brushed copper metal OPM12	Brushed antique brass metal OPM13	Brushed antique gold metal OPM15	Anodized Bronze metal OPM18
Base in metallo Metal base										
Code	Shiny chrome metal OPM1	Brushed matt chrome metal OPM2	Brushed matt dark grey metal OPM3	RAL 9017 black painted metal OPM6	RAL 9016 white painted metal OPM7	Classic bronze painted metal OPM9	Golden beach painted metal OPM10	Gold pearl painted metal OPM11		
										
Code	Brushed copper metal OPM12	Brushed antique brass metal OPM13	Shiny black chrome metal OPM14	Brushed antique gold metal OPM15	Shiny brass chrome metal OPM16	Bronze metal OPM17	Anodized Bronze metal OPM18			

Gary

DESIGN
STUDIO MARELLI
2019

Fusto in legno massello e legno multistrato con cinghie elastiche intrecciate. Imbottitura in poliuretano espanso rivestito in vellutino bianco. Sedute e schienali costituiti da un cuore in poliuretano espanso a quote differenziate 30 Kg/m³ e 40 Kg/m³, ricoperto da un trapuntino di vera piuma imbottito a scomparti*. Completamente sfoderabile in tessuto, non sfoderabile in pelle e finta pelle. Kit letto non disponibile.

*Manutenzione dei cuscini contenenti piuma: I cuscini contenenti piuma tendono a deformarsi con l'utilizzo. Per mantenerne la forma è necessario, anche dopo un breve utilizzo, battere e sprimacciare ripetutamente i cuscini. Non utilizzare mai battipanni o aspirapolvere. A coloro che non desiderassero seguire queste indicazioni o che volessero un divano dall'aspetto meno vissuto, raccomandiamo di preferire dei cuscini in gomma.

Carcasse en bois massif et multiplis muni de bandes élastiques entrecroisées et finie de mousse polyuréthane couverte de dacron.

Assises et dossiers composés d'un noyau en mousse polyuréthane de différentes densités de 30 kg/m³ et 40 kg/m³ couvert de véritable duvet matelassé en compartiments. Revêtement complètement déhoussable en tissu, fixe en cuir et cuir look.*

*Pas disponible en canapé-lit. *Entretien de coussins en duvet: Coussins en duvet ont tendance à perdre leur forme dû à l'usage.*

Pour en conserver la forme il est nécessaire, aussi après un usage court, de régulièrement battre les coussins. Ne jamais utiliser la tapette ou l'aspirateur.

À ceux qui ne désirent pas suivre ces indications ou qui souhaitent un canapé qui ait l'air moins "usé", nous conseillons vivement de choisir des coussins en mousse polyuréthane.

Frame made of solid wood and multi-ply wood with interwoven elastic belts. The upholstery is made of polyurethane foam, covered with dacron.

Seats and backs are made of a polyurethane foam core in different densities of 30 Kg/m³ and 40 Kg/m³, covered with a feather compartments quilt.*

Fully removable fabric covers, fixed leather and artificial leather covers.

Sofa-bed is not available.

**Maintenance of feather cushions:*

Cushions filled with feathers tend to change their shape with use. In order to keep their shape it is necessary, even after a short use, to plump up the cushions repeatedly. Never use carpet beater or vacuum cleaner.

We recommend to choose foam cushions to those who do not wish to follow these instructions or to have a "used look" sofa.

Каркас из массива дерева в сочетании с многослойной фанерой покрыт слоем вспененного полиуретана плотностью 40 кг/м³, обернутого в дакрон, подвеска из перекрещивающихся эластичных ремней. В основе наполнения подушек сиденья и спинки вспененный полиуретан различной степени плотности – 30 и 40 кг/м³, покрытый стеганым полотном с наполнением из натурального пуха.

Целиком съёмные чехлы в ткани и несъёмные в коже, как натуральной, так и искусственной.

Уход за подушками с наполнением из натурального пуха:

Das Gestell besteht aus Massiv- und Schichtholz, mit geflochtenen Gummigurten, gepolstert mit Polyurethanschaumstoff, mit Dacron bezogen.

Sitze und Rücken bestehen aus einem Schaumkern in verschiedenen Dichten von 30 Kg/m³ und 40 Kg/m³ mit einer gekammerten Daunenauflage.*

Stoffbezüge alle abziehbar, Leder und Kunstleder festbezogen. Als Bettsofa nicht verfügbbar.

**Wartungsanleitungen fuer Daunenkissen:*

Die Kissen, die Daunen enthalten, neigen dazu, sich durch Gebrauch zu verformen.

Um die ursprüngliche Form zu halten, ist es notwendig, auch nach kurzem Gebrauch, die Kissen wiederholt aufzuschueteln. Keinen Ausklopfer oder Staubsauger verwenden. Unseren Kunden, die diese Anweisungen nicht befolgen moechten, oder die kein Sofa mit solchem "gebrauchten" Aussehen haben moechten, empfehlen wir Polyurethan-Kissen.

В процессе эксплуатации подушек с наполнением из натурального пуха естественным их деформация неизбежна. Чтобы сохранить форму подушек, их необходимо регулярно взбивать, при этом ни в коем случае не прибегая к использованию выбивалки для одежды или пылесоса. Заказчикам, которые не будут следовать данной рекомендации либо просто предпочитают диваны с недеформируемыми подушками, фабрика рекомендует заказывать наполнение из полиуретана.

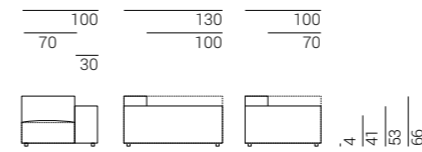

Elementi componibili Modular elements



9GY201
Laterale con bracciolo basso
Side element with low armrest
L130 P100 H66

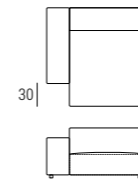

9GY202
Laterale con bracciolo basso
Side element with low armrest
L130 P130 H66

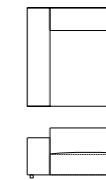

9GY203
Laterale con bracciolo basso
Side element with low armrest
L130 P130 H66



9GY401
L100 P100 H41



9GY402
L100 P130 H41



9GY403
L100 P70 H41

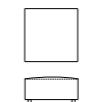

9GY404
L70 P70 H41

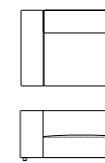

9GY204
Laterale con bracciolo alto
Side element with high armrest
L130 P100 H66

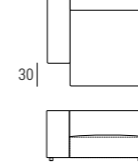

9GY205
Laterale con bracciolo alto
Side element with high armrest
L130 P130 H66

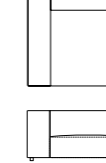

9GY206
Laterale con bracciolo alto
Side element with high armrest
L130 P130 H66

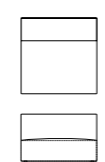

9GY301
Elemento centrale
Central element
L100 P100 H66

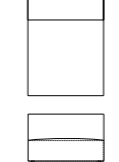

9GY302
Elemento centrale
Central element
L100 P130 H66

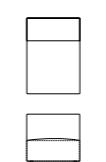

9GY303
Elemento centrale
Central element
L70 P100 H66

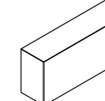

9GY502
Elemento schienale/bracciolo
Back/armrest element
L130 P30 H50

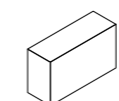

9GY501
Elemento schienale/bracciolo
Back/armrest element
L100 P30 H50

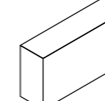

9GY504
Elemento schienale/bracciolo
Back/armrest element
L130 P30 H60

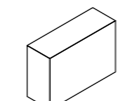

9GY503
Elemento schienale/bracciolo
Back/armrest element
L100 P30 H60

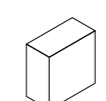

9GY505
Elemento schienale/bracciolo
Back/armrest element
L70 P30 H50

Accessori Accessories

Cuscino in piuma con profilo
Feather cushions with piping



9GY101
L40 P40

Cuscino in piuma con profilo
Feather cushions with piping



9GY102
L45 P45

Cuscino in piuma con profilo
Feather cushions with piping



9GY103
L60 P60

Gary

DESIGN
STUDIO MARELLI
2019

Gordon

DESIGN
STUDIO MARELLI
2014

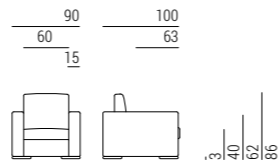

Gordon

DESIGN
STUDIO MARELLI
2014

Divani
Sofas

Elementi componibili
Modular elements











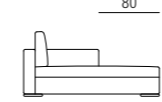
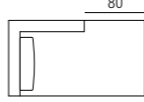

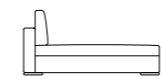

Divani letto
Sofa-beds

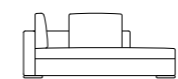
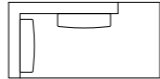
Dormeuse
Longchair

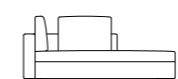
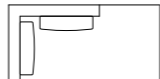
Pouf e accessori
Pouf and accessories

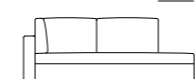
Piedini
Feet

 960101 L90 P100 H86	 960301 L115 P100 H86	Elemento angolare Corner element  960207 L100 P100 H86	 960213 L190 P100 H86	 Materasso Mattress L115 P190 H15
 960202 L170 P100 H86	 960302 L135 P100 H86	Elemento angolare Corner element  960208 L125 P100 H86	 960214 L210 P100 H86	 Materasso Mattress L145 P190 H15
 960203 L190 P100 H86	 960303 L155 P100 H86	 960401 L100 P100 H86	 960215 L230 P100 H86	 Materasso Mattress L160 P190 H15
 960204 L210 P100 H86	 960304 L175 P100 H86	 960402 L140 P100 H86	 960216 L250 P100 H86	 Materasso Mattress L160 P190 H15
 960205 L230 P100 H86	 960305 L195 P100 H86	 960403 L160 P100 H86	 960314 L175 P100 H86	 Materasso Mattress L115 P190 H15
 960206 L250 P100 H86	 960306 L215 P100 H86	 960404 L180 P100 H86	 960315 L195 P100 H86	 Materasso Mattress L145 P190 H15
			 960316 L215 P100 H86	 Materasso Mattress L160 P190 H15

 960102 L180 P98 H86		 960110 L100 P75 H40	 960103 L40 H40	Cuscinetto in piuma senza fascia Feather cushion without band
 960103 L180 P98 H86		 960111 L100 P100 H40	 960105 L50 H50	Cuscinetto in piuma senza fascia Feather cushion without band
 960104 L200 P98 H86		 960112 L100 P125 H40	 960103 L40 H40	Cuscinetto trapuntato in piuma senza fascia Quilted feather cushion without band
 960105 L200 P98 H86			 960104 L60 H60	Cuscinetto trapuntato in piuma senza fascia Quilted feather cushion without band
 960106 L225 P98 H86			 960107 L45 H45	Cuscinetto in piuma con fascia Feather cushion with band
			 960109 L80 H40	Cuscinetto in piuma con fascia Feather cushion with band

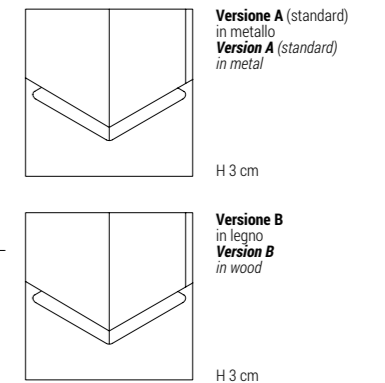

Gordon Move

DESIGN
STUDIO MARELLI
2014

Movimento schienali
Backrest mechanism

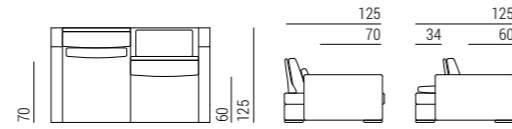

Divani
Sofas

Elementi componibili
Modular elements

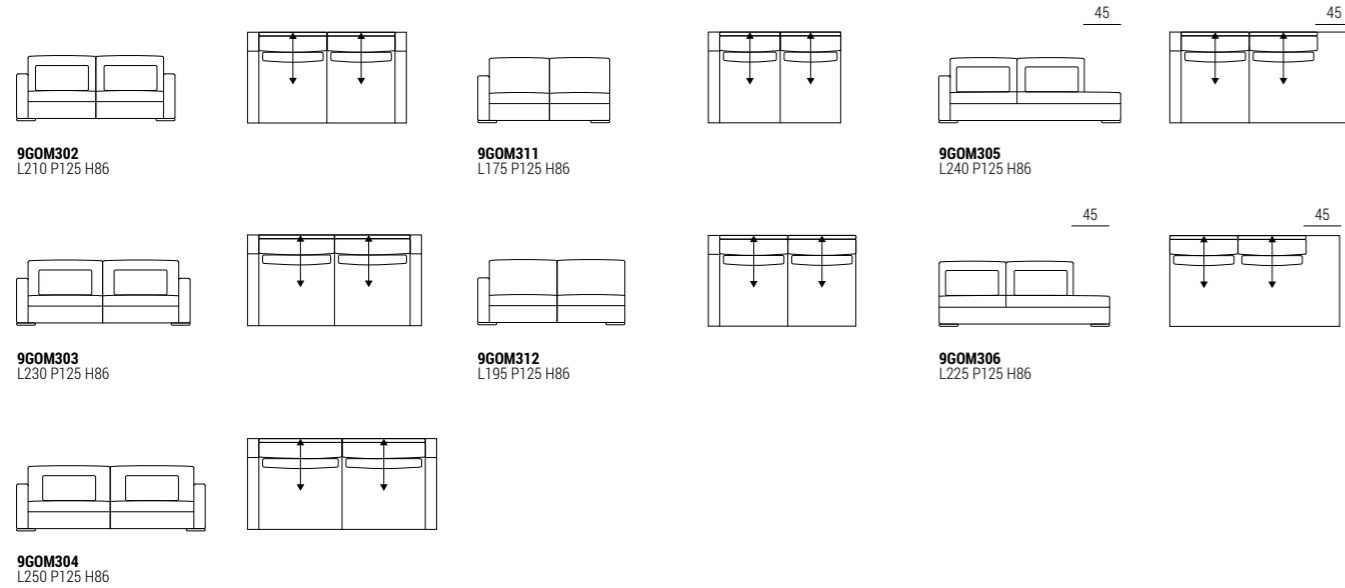

Pouf e accessori
Pouf and accessories

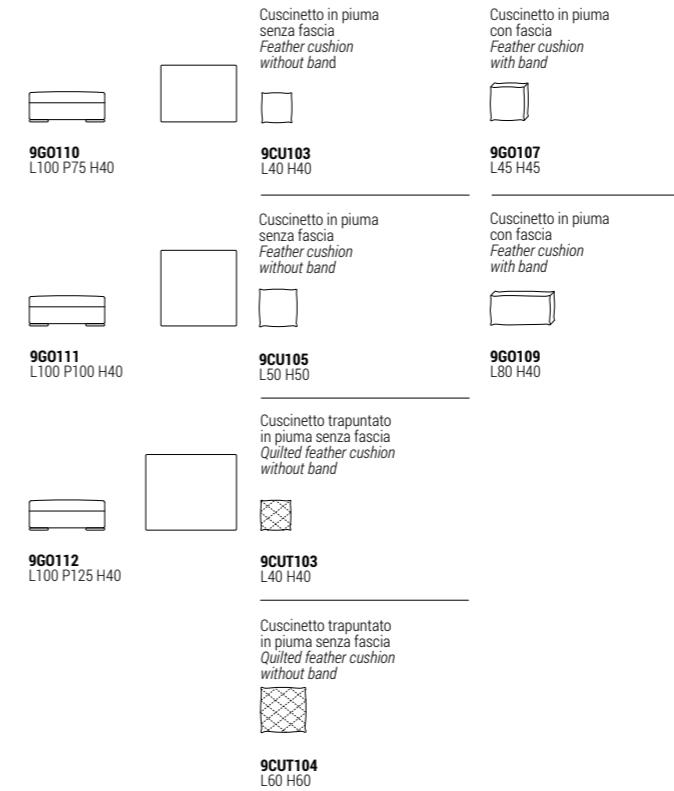

Piedini
Feet

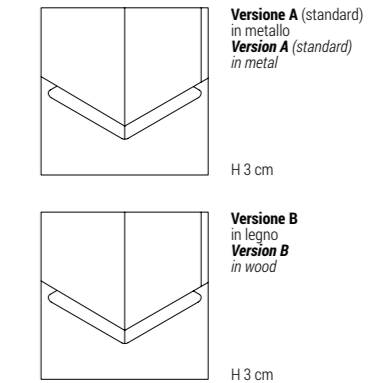

Gli elementi componibili Gordon Move possono essere liberamente combinati con gli elementi Gordon per creare infinite composizioni

The different elements of Gordon Move can be combined with the modular elements of Gordon to create several and different compositions

Gordon Move

DESIGN
STUDIO MARELLI
2014

Gordon Quilted

DESIGN
STUDIO MARELLI
2014

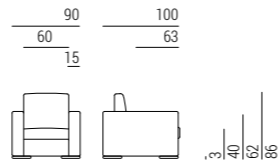

Gordon Quilted

DESIGN
STUDIO MARELLI
2014

Divani
Sofas







Elementi componibili
Modular elements

Divani letto
Sofa-beds

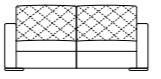

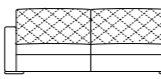

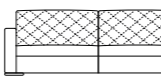

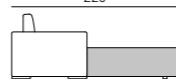
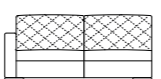
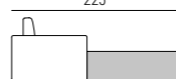

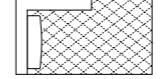
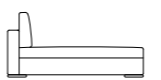
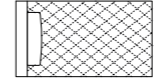
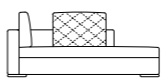
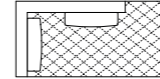
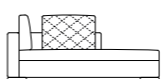
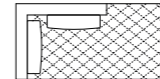
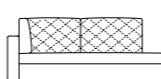
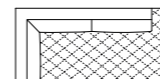



Dormeuse
Longchair

Pouf e accessori
Pouf and accessories

Piedini
Feet

 9GT101 L90 P100 H86	 9GT301 L115 P100 H86	Elemento angolare Corner element 		 9GT213 L190 P100 H86	 Materasso Mattress L115 P190 H15
 9GT202 L170 P100 H86	 9GT302 L135 P100 H86	Elemento angolare Corner element 		 9GT214 L210 P100 H86	 Materasso Mattress L145 P190 H15
 9GT203 L190 P100 H86	 9GT303 L155 P100 H86	 9GT402 L140 P100 H86	 9GT215 L230 P100 H86	 Materasso Mattress L160 P190 H15	
 9GT204 L210 P100 H86	 9GT304 L175 P100 H86	 9GT403 L160 P100 H86	 9GT216 L250 P100 H86	 Materasso Mattress L160 P190 H15	
 9GT205 L230 P100 H86	 9GT305 L195 P100 H86	 9GT404 L180 P100 H86	 9GT314 L175 P100 H86	 Materasso Mattress L115 P190 H15	
 9GT206 L250 P100 H86	 9GT306 L215 P100 H86	 9GT405 L200 P100 H86	 9GT315 L195 P100 H86	 Materasso Mattress L145 P190 H15	
			 9GT316 L215 P100 H86	 Materasso Mattress L160 P190 H15	

 9GT102 L180 P98 H86	
 9GT103 L180 P98 H86	
 9GT104 L200 P98 H86	
 9GT105 L200 P98 H86	
 9GT106 L225 P98 H86	

 9GT110 L100 P75 H40		Cuscinetto in piuma senza fascia Feather cushion without band
 9GT111 L100 P100 H40		Cuscinetto in piuma senza fascia Feather cushion without band
 9GT112 L100 P125 H40		Cuscinetto trapuntato in piuma senza fascia Quilted feather cushion without band
 9GT107 L45 H45		Cuscinetto trapuntato in piuma senza fascia Quilted feather cushion without band
 9GT108 L45 H45		Cuscinetto in piuma con fascia Feather cushion with band
 9GT109 L80 H40		Cuscinetto in piuma con fascia Feather cushion with band

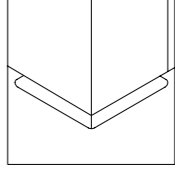
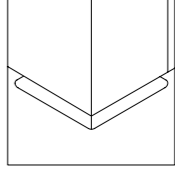
	Versione A (standard) in metallo Version A (standard) in metal	H 3 cm
	Versione B in legno Version B in wood	H 3 cm

Gordon Move Quilted

DESIGN
STUDIO MARELLI
2014

Movimento schienali
Backrest mechanism

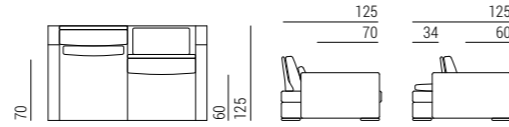

Divani
Sofas

Elementi componibili
Modular elements

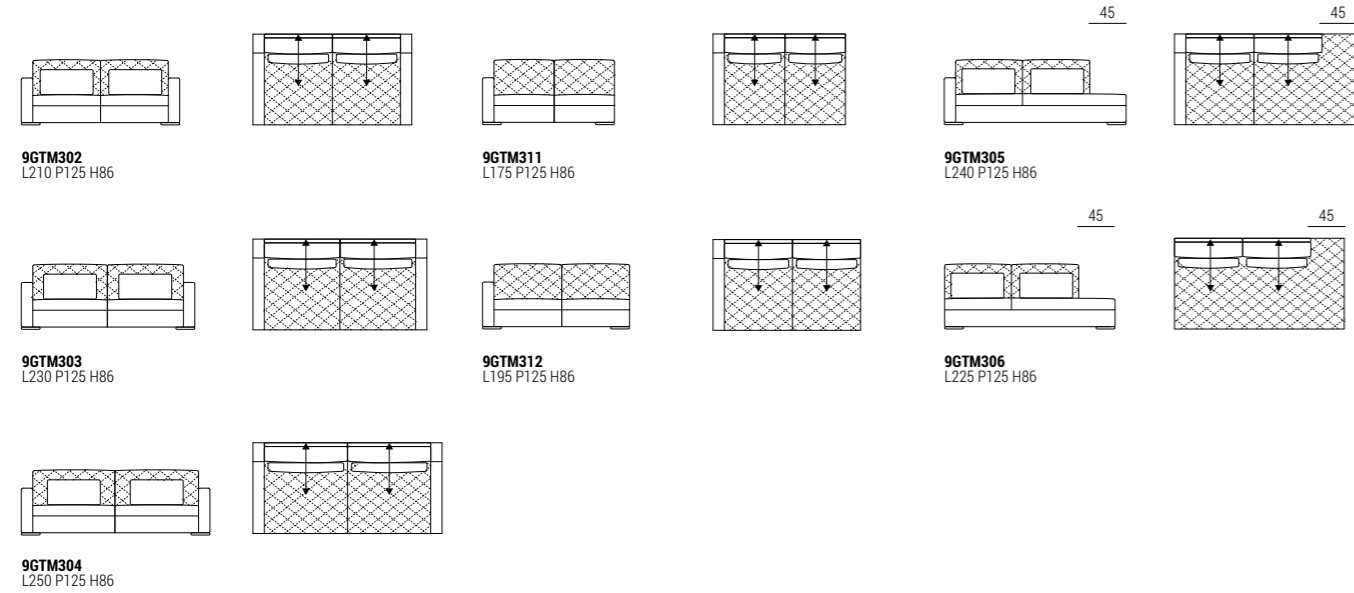

Gli elementi componibili Gordon Move possono essere liberamente combinati con gli elementi Gordon per creare infinite composizioni

The different elements of Gordon Move can be combined with the modular elements of Gordon to create several and different compositions

Gordon Move Quilted

DESIGN
STUDIO MARELLI
2014

Pouf e accessori
Pouf and accessories



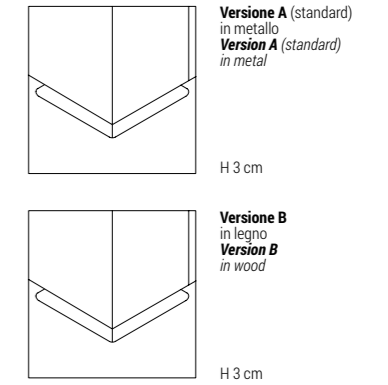
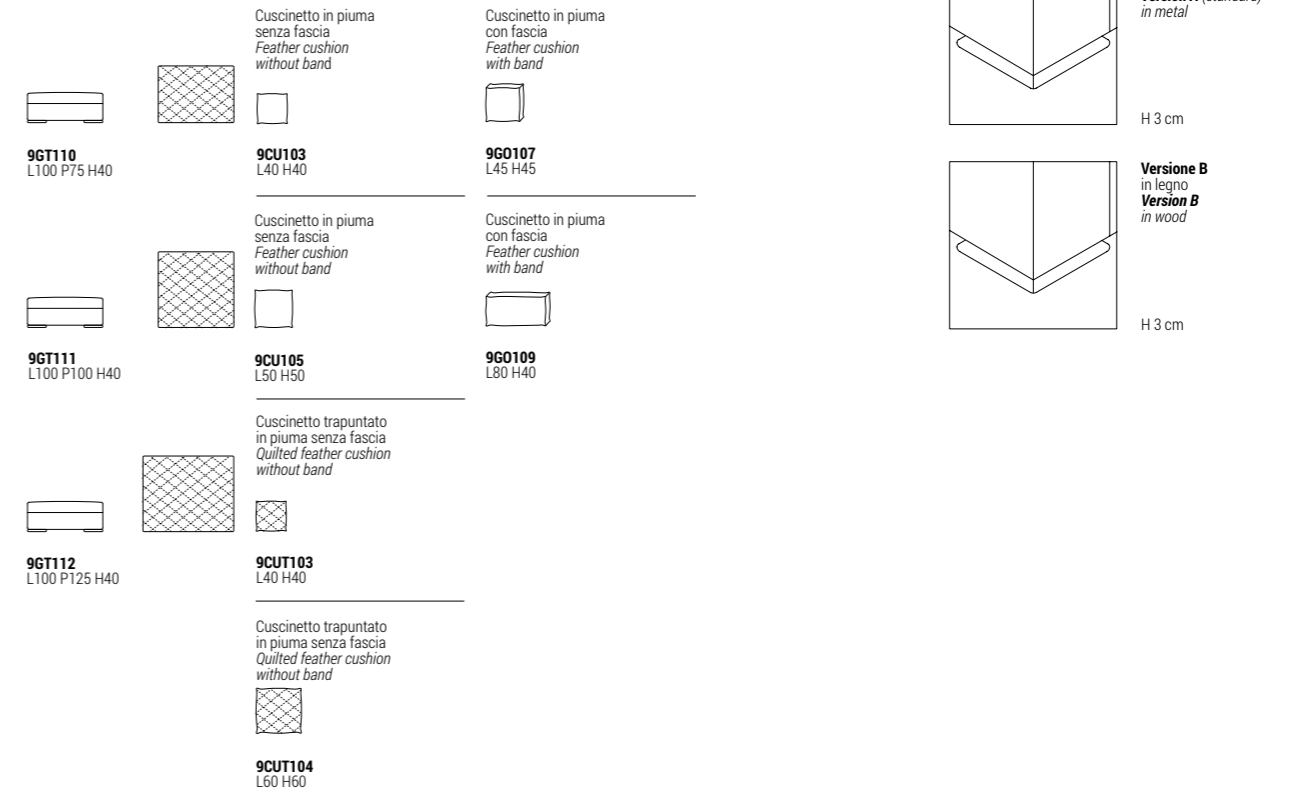













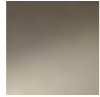



Piedini
Feet



Gordon

DESIGN
STUDIO MARELLI
2014

Finiture Finishes

Piedini in metallo Versione A Metal feet version A																			
Code	Shiny chrome metal OPM1	Brushed matt chrome metal OPM2	Brushed matt dark grey metal OPM3	RAL 9017 traffic black painted metal OPM6	Classic bronze painted metal OPM9	Brushed copper metal OPM12													
																			
Code	Brushed antique brass metal OPM13	Shiny black chrome metal OPM14	Brushed antique gold metal OPM15	Shiny brass chrome metal OPM16	Bronze metal OPM17	Anodized bronze metal OPM18													
Piedini in legno Versione B Wooden feet version B																			
Code	Cherry stained beech OPF1	Wengé stained beech OPF2	Walnut stained beech OPF3	Natural beech OPF4	Black stained beech OPF5	Cherry Milano stained beech OPF6	Tobacco stained beech OPF8	Grey taupe stained beech OPF9	Charcoal stained beech OPF11	Mahogany stained beech OPF12									

Fusto in legno massello e legno multistrato con cinghie elastiche intrecciate. Imbottitura in poliuretano espanso rivestito in vellutino bianco. Cuscini di schienale in Piumafib, una speciale miscela ipoallergenica di vera piuma e fibra poliestere siliconata*.

Cuscini di seduta costituiti da un inserto in poliuretano con densità di 30 Kg/m³ ricoperto da un trapuntino di vera piuma imbottito a scomparti*.

Completamente sfoderabile in tessuto, non sfoderabile in pelle e finta pelle. Kit letto disponibile.

Disponibile anche nella versione con cuscini di seduta e schienale trapuntati

* Manutenzione dei cuscini contenenti piuma:

I cuscini contenenti piuma tendono a deformarsi con l'utilizzo.

Per mantenerne la forma è necessario, anche dopo un breve utilizzo, battere e sprimacciare ripetutamente i cuscini. Non utilizzare mai battipanni o aspirapolvere.

A coloro che non desiderassero seguire queste indicazioni o che volessero un divano dall'aspetto meno vissuto, raccomandiamo di preferire dei cuscini in gomma.

Carcasse en bois massif et multiplies muni de bandes élastiques entrecroisées et finie de mousse polyuréthane couverte de dacron. Coussins de dossier en Piumafib, un mélange hypoallergénique spécial de véritable duvet et fibre polyester siliconisée*.

Les coussins d'assise sont composés d'un noyau en mousse polyuréthane d'une densité de 30 kg/m³ couvert de véritable duvet matelassé en compartiments*. Revêtement complètement déhoussable en tissu, fixe en cuir et cuir look.

Disponibile en canapé-lit. Également disponible avec les coussins d'assise et de dossier matelassés.

* Entretien de coussins en duvet:

Coussins en duvet ont tendance à perdre leur forme dû à l'usage.

Pour en conserver la forme il est nécessaire, aussi après un usage court, de régulièrement battre les coussins. Ne jamais utiliser la tapette ou l'aspirateur. À ceux qui ne désirent pas suivre ces indications ou qui souhaitent un canapé qui ait l'air moins "usé", nous conseillons vivement de choisir des coussins en mousse polyuréthane.

Frame made of solid wood and multi-ply wood with interwoven elastic straps. The upholstery is made of polyurethane foam, covered with dacron. The back cushions are filled with Piumafib, a special hypoallergenic mixture of feathers and siliconised polyfibre*.

The seat cushions are made of a foam insert with density of 30 Kg/m³, covered with a feather compartments quilt*.

Fully removable fabric covers, fixed leather and artificial leather covers.

Sofa-bed is available.

Available also with quilted seat and back cushions.

* Maintenance of feather cushions:

Cushions filled with feathers tend to change their shape with use.

In order to keep their shape it is necessary, even after short use, to plump up the cushions repeatedly. Never use carpet beater or vacuum cleaner.

We recommend to choose foam cushions to those who do not wish to follow these instructions or to have a "used look" sofa.

Romp in massief hout en multiplex, voorzien van door elkaar geweven elastische singels en bekleed met koudschuim afgewerkt met dacron. Rugkussens in Piumafib, een speciale hypoallergene mengeling van echt dons en gesiliconiseerde polyestervezel*.

De zitkussens bestaan uit een kern in koudschuim met een densiteit van 30 kg/m³ met daarbovenop een in vakken doorstikte laag echt dons*.

Volledig afneembare bekleding in stof, vaste bekleding in leder en lederlook.

Ook verkrijgbaar als bedbank.

Ook verkrijgbaar met doorstikte zit- en rugkussens.

* Onderhoud van kussens met dons vulling:

Kussens met dons vulling hebben de neiging door het gebruik hun vorm te verliezen.

Om hun vorm te behouden is het noodzakelijk, ook na kort gebruik, de kussens regelmatig op te kloppen. Nooit een mattenklopper of stofzuiger gebruiken.

Wie deze voorschriften niet wenst te volgen of een zitmeubel wenst dat er minder "sordig" uitziet, raden wij met aandrang aan voor kussens met koudschuimvulling te kiezen.

Das Gestell besteht aus Massiv- und Schichtholz, mit geflochtenen Gummigurten, gepolstert mit Polyurethanschaumstoff, mit Dacron bezogen. Rueckenkissen aus Piumafib, einer hypoallergischen speziellen Mischung aus echter Daune und silikonisierter Polyesterfaser*.

Die Sitzkissen bestehen aus einem Schaumkern mit Dichte 30 Kg/m³ mit einer gekammerten Daunenauf-lage*.

Stoffbezüge alle abziehbar, Leder und Kunstleder festbezogen.

Als Bettsofa verfügbare.

Verfügbare auch mit abgesteppten Sitz- und Rueckenkissen.

* Wartungsanleitungen fuer Daunenkissen:

Die Kissen, die Daunen enthalten, neigen dazu, sich durch Gebrauch zu verformen.

Um die urspruengliche Form zu halten, ist es notwendig, auch nach kurzem Gebrauch, die Kissen wiederholt aufzuschueteln.

Keinen Ausklopper oder Staubsauger verwenden.

Unseren Kunden, die diese Anweisungen nicht befolgen moechten, oder die kein Sofa mit solchem "gebrauchten" Aussehen haben moechten, empfehlen wir Polyurethan-Kissen.

Для производства каркаса используется массив дерева и многослойная фанера в сочетании с перекрещивающимися эластичными ремнями. Наполнение из полиуретана, обернутого в белый бархат. Наполнение подушек спинки выполнено из материала Piumafib – специальной, не вызывающей аллергию смеси из натурального пуха и полиэфирных силиконовых волокон*.

Подушки сиденья: стеганые по отсекам, наполнение из натурального пуха с вставками из полиуретана плотностью 30 кг/м³ *.

Полностью съемные чехлы из ткани, несъемные чехлы из кожи.

Исполнение дивана в версии со спальным местом: возможно Также возможно изготовление подушек сиденья и спинки с декоративной прострочкой

* Эксплуатация подушек с пуховым наполнением:

В процессе эксплуатации подушки с пуховым наполнением могут деформироваться, во избежание чего их необходимо слегка взбивать вручную даже после непродолжительного нахождения на диване.

Использование в этих целях пылесоса или выбивалки для одежды категорически запрещено. Если клиент не планирует следовать данным инструкциям и хочет, чтобы подушки сиденья и спинки проминались по минимуму, посоветуйте выбрать наполнение только из полиуретана, полностью исключив натуральный пух.

Gordon

DESIGN
STUDIO MARELLI
2014

Joy

DESIGN
ELEONORA POZZI
2016

Struttura in tubolare di metallo ricoperto con schiuma di poliuretano a freddo ignifugo, classe 11M, rivestito con una fodera in fibra acrilica. Cuscino di seduta in poliuretano espanso con densità 40 kg/m³ (5,9 KPA), rivestito in fibra acrilica. Il rivestimento è sempre fisso.

Structure en métal tubulaire recouvert de mousse à froid ignifuge classe 11M, recouverte d'une housse en fibre acrylique. Coussin d'assise en mousse de polyuréthane avec une densité de 40 kg/m³ (5,9 kPa), recouverte de fibre acrylique. Le revêtement est toujours fixe.

Metal tube structure upholstered with cold injected fire retardant polyurethane foam class 11M, covered with acrylic fibre. Seat cushion in polyurethane foam with density 40 kg/m³ (5,9 KPA), lined with acrylic fibre. Fixed covers.

Каркас выполнен из профильной металлической трубы, покрытой слоем огнестойкого пенополиуретана холодного формования, класс 1 1M, и помещенной в чехол из акрилового воловкна. Наполнение подушки сиденья выполнено из вспененного полиуретана плотностью 40 кг/м³ (5,9 кПа), помещенного в чехол из акрилового волокна. Обивка только несъемная.

Struktur der Sitzschale in Metall überschäumt mit Polyurethan-Kaltschaumstoff, Feuerwiderstandsklasse 11M, mit Acrylfaser ummantelt. Sitzkissen aus Polyurethan-Schaumstoff mit Dichte 40 Kg/m³ (5,9 KPA), mit Acrylfaser ummantelt. Bezüge immer fix, nicht abziehbar.

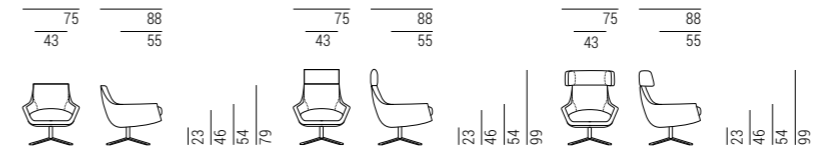

Poltrone girevoli Swivel armchairs



9JY104
L75 P82 H99
Poltrona girevole
con schienale alto
Swivel high
wingback chair



9JY101
L75 P82 H99
Poltrona girevole
con schienale alto
Swivel armchair
with high back



9JY102
L75 P82 H79
Poltrona girevole
con schienale basso
Swivel armchair
with low back



9JY103
L60 P44 H39
Pouf girevole
Swivel pouf

Pouf girevole Swivel ottoman

Basi girevoli Swivel bases

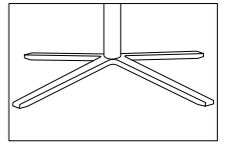

Versione A tubolare in metallo
Version A tubular in metal

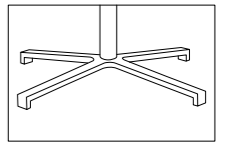

Versione B tubolare in metallo
Version B tubular in metal

Poltrone Armchairs

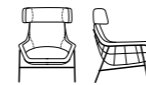

9JY107
L75 P82 H99
Poltrona
con schienale alto
High wingback chair



9JY106
L75 P82 H99
Poltrona
con schienale alto
Armchair with high back



9JY105
L75 P82 H79
Poltrona
con schienale basso
Armchair with low back



9JY108
L75 P82 H79
Poltrona girevole
con schienale basso
Swivel armchair
with low back

Joy

DESIGN
ELEONORA POZZI
2016

Joy
DESIGN
ELEONORA POZZI
2016

Kyoto
DESIGN
MARCO CATTANEO
2019

Finiture
Finishes

Base girevole in metallo A <i>Swivel metal base A</i>								
Code	Shiny chrome metal OPM1	Brushed matt chrome metal OPM2	Brushed matt dark grey metal OPM3	RAL 9017 black painted metal OPM6	RAL 9016 white painted metal OPM7	Classic bronze painted metal OPM9	Golden beach painted metal OPM10	Gold pearl painted metal OPM11
Code	Brushed copper metal OPM12	Brushed antique brass metal OPM13	Shiny black chrome metal OPM14	Brushed antique gold metal OPM15	Shiny brass chrome metal OPM16	Bronze metal OPM17	Anodized bronze painted metal OPM18	
Base girevole in metallo B <i>Swivel metal base B</i>								
Code	Shiny chrome metal OPM1	Brushed matt chrome metal OPM2	RAL 9017 black painted metal OPM6	Classic bronze painted metal OPM9				
9JY105 9JY106 9JY107 9JY108 Base in metallo <i>Metal base</i>								
Code	RAL 9017 traffic black painted metal OPM6	Classic bronze painted metal OPM9	Golden beach painted metal OPM10	Gold pearl painted metal OPM11	Anodized bronze metal OPM18			

Tavolini
Coffee tables

7KY101 Top marmo/Marble top 7KY102 Top vetro/Glass top Ø40 H48	7KY103 Top marmo/Marble top 7KY104 Top vetro/Glass top Ø50 H38	7KY105 Top marmo/Marble top 7KY106 Top vetro/Glass top Ø50 H48	Top: vetro extra light temperato, spessore 6 mm <i>Top: extralight tempered glass, 6 mm thick</i>
			Top: marmo, spessore 20 mm <i>Top: marble, 20 mm thick</i>
7KY107 Top marmo/Marble top 7KY108 Top vetro/Glass top Ø80 H38	7KY109 Top marmo/Marble top 7KY110 Top vetro/Glass top Ø100 H38	7KY111 Top marmo/Marble top 7KY112 Top vetro/Glass top L120 P60 H38	7KY113 Top marmo/Marble top 7KY114 Top vetro/Glass top L80 P80 H38

Tavoli da pranzo
Dining tables

7KY201 Top marmo/Marble top 7KY202 Top legno/Wooden top L200 P110 H74	7KY203 Top marmo/Marble top 7KY204 Top legno/Wooden top L220 P110 H74	7KY205 Top marmo/Marble top 7KY206 Top legno/Wooden top L250 P110 H74

Madia
Sideboard

7KY207 Top superiore in marmo <i>Marble upper top</i> L220 P50 H71

Credenza
Cupboard

7KY208 Top superiore in marmo <i>Marble upper top</i> L220 P50 H50	7KY209 Top superiore in marmo <i>Marble upper top</i> L100 P50 H125
7KY210 Top superiore in marmo <i>Marble upper top</i> L100 P50 H105	

























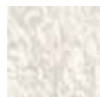











Kyoto

















DESIGN
MARCO CATTANEO
2019

Kyoto

DESIGN
MARCO CATTANEO
2019

Finiture
Finishes

Top in marmo <i>Marble top</i>										
	White Carrara marble OPP1	Black Marquinia marble OPP2	Brown Emperador marble OPP3	Calacatta gold marble OPP7	Black and gold marble OPP9	Perfetto brown marble OPP10				
										
Code	Grey Stone marble OPP11	Guatemala green marble OPP12	Velvet brown marble OPP13	Amani Bronze marble OPP14	Covelano white marble OPP15					
Top in Gres Porcellanato <i>Porcelain Stoneware Top</i>										
Code	Carrara Pure OPG1	Nero Marquinia OPG2	Statuario Select OPG3	Calacatta Royal OPG4						
Top in vetro <i>Glass top</i>										
Code	Transparent glass OPV1	Frosted glass OPV2	RAL 9016 traffic white back-painted glass OPV3	RAL 9017 traffic black back-painted glass OPV4	RAL 7044 silk grey back-painted glass OPV5	RAL 1019 grey beige back-painted glass OPV6	Chrome back-painted bronze glass OPV9	Chrome back-painted grey glass OPV10	Transparent bronze glass OPV12	Transparent grey glass OPV13
Top in rovere impiallacciato <i>Oak veneer top</i>										
Code	Cherry stained oak OPR1	Wengé stained oak OPR2	Walnut stained oak OPR3	Natural oak OPR4	Black stained oak OPR5	Cherry Milano stained oak OPR6				
										
Code	Tobacco stained oak OPR8	Grey taupe stained oak OPR9	Whitened oak OPR10	Charcoal stained oak OPR11	Mahogany stained oak OPR12	Moka matt stained oak OPR15				

Base in metallo <i>Metal base</i>									
Code	Shiny chrome metal OPM1	Brushed matt chrome metal OPM2	Brushed matt dark grey metal OPM3	RAL 9017 black painted metal OPM6	RAL 9016 white painted metal OPM7	Classic bronze painted metal OPM9	Golden beach painted metal OPM10	Gold pearl painted metal OPM11	Brushed copper metal OPM12
									
Code	Brushed antique brass metal OPM13	Shiny black chrome metal OPM14	Brushed antique gold metal OPM15	Shiny brass chrome metal OPM16	Bronze metal OPM17	Anodyc Bronze metal OPM18			
Struttura media/credenza <i>Sideboard/cupboard structure</i>									
Code	Moka matt stained oak OPR15								

L-Sofa

DESIGN
JÉRÔME GAUTHIER
2013

Struttura portante costituita da due tubolari di metallo cm 4 x 3. Piede in metallo diametro cm 2,5. Pannelli in multistrato impiallacciato rovere, spessore 2,1 cm. Cuscini in poliuretano espanso a quote differenziate, rivestito in dacron 100 gr: sedile T.40RC (kPa5); schienale PF30 (kPa4,3), PF30M (kPa 3,5), T.30HR (kPa 1,5); braccioli PF30 (kPa 4,3), T.30HR (kPa 1,5). Il rivestimento è sempre fisso.

Structure portante constituée de deux tubes en métal de 4 x 3 cm. Pied en métal diamètre 2,5 cm. Panneaux en multiplis plaqués chêne, épaisseur 2,1 cm. Coussins en mousse polyuréthane de différentes densités, revêtue de dacron 100 g: assise T.40RC (kPa5); dossier PF30 (kPa4,3), PF30M (kPa 3,5), T.30HR (kPa 1,5); accoudoirs PF30 (kPa 4,3), T.30HR (kPa 1,5). Le revêtement est toujours fixe.

Frame made of two metal tubes cm 4 x 3. Metal leg diameter cm 2.5. Multiply oak veneer panels, 2.1 cm thick. Cushions made of polyurethane foam in different densities, covered with dacron 100 gr: seat T.40RC (kPa5); back PF30 (kPa4,3), PF30M (kPa 3,5), T.30HR (kPa 1,5); armrests PF30 (kPa 4,3), T.30HR (kPa 1,5). Covers are always fixed.

Несущий каркас образован двумя металлическими планками, размер в сечении 4 x 3 см. Металлические ножки диаметром 2,5 см. Панели из многослойной фанеры, отделанной шпоном дуба, толщина панели 2,1 см. Наполнение подушек: вспененный полиуретан с участками различной плотности в чехле из дакрона весом 100 гр.

Gestellkonstruktion mit 2 Querträgern 4-Kantrohr 4 x 3 cm, Metallfüsse mit Durchmesser 2,5 cm. Rücken- und Armlehnelemente aus Schichtholz Eiche furniert, Dicke 2,1 cm. Kissen aus Polyurethanschäumstoff in unterschiedlichen Dichten, mit Dacron 100 gr ummantelt: Sitzkissen T.40RC (kPa5); Rückenkissen PF30 (kPa4,3), PF30M (kPa 3,5), T.30HR (kPa 1,5); Armlehnkissen PF30 (kPa 4,3), T.30HR (kPa 1,5). L-Sofa ist immer fix bezogen.

Подушка сиденья T.40RC (kPa5); подушка спинки schienale PF30 (kPa4,3), PF30M (kPa 3,5), T.30HR (kPa 1,5); подлокотники PF30 (kPa 4,3), T.30HR (kPa 1,5). Чехлы несъемные.

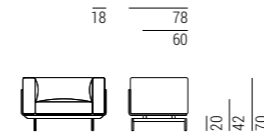

L-Sofa

DESIGN
JÉRÔME GAUTHIER
2013

Divani
Sofas

Elementi componibili
Modular elements

Pouf e accessori
Ottomans and accessories

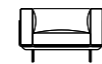

9LF101
L112 P78 H70

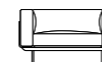

9LF102
L128 P78 H70



9LF201
L188 P78 H70

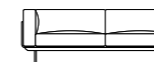

9LF202
L220 P78 H70



9LF207
L260 P78 H70

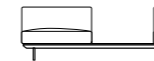

9LF208
L276 P78 H70



9LF203
L170 P78 H70



9LF204
L202 P78 H70

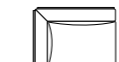

9LF103
L110 P78 H70



9LF107
L94 P78 H70

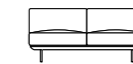

9LF205
L152 P78 H70



9LF206
L184 P78 H70



9LF104
L92 P78 H70



9LF108
L76 P78 H70



9LF105
L92 P92 H42



9LF106
L108 P108 H42



7LF101
L92 P92 H23



7LF102
L108 P108 H23

Top in legno
Wood Top

Cuciture opzionali
Optional stitchings

Punto Cavallo Stitching



L-Sofa

DESIGN
JÉRÔME GAUTHIER
2013

Leaf

DESIGN
STUDIO MARELLI
2009



Finiture Finishes

Pannelli in legno Wooden panels										
Code	Cherry stained oak OPR1	Wengé stained oak OPR2	Walnut stained oak OPR3	Natural oak OPR4	Black stained oak OPR5	Cherry Milano stained oak OPR6	Tobacco stained oak OPR8	Grey taupe stained oak OPR9	Whitened oak OPR10	
Code	Charcoal stained oak OPR11	Mahogany stained oak OPR12	Oak painted in RAL Classic colours OPR14	Moka matt stained oak OPR15						
Base standard Standard base										
Code	RAL 9017 black painted metal OPM6	RAL 9016 white painted metal OPM7	Classic bronze painted metal OPM9	RAL 9006 white aluminium painted metal OPM8	Anodyc Bronze painted metal OPM18					
Base optional Optional base										
Code	Shiny chrome metal OPM1	Brushed matt chrome metal OPM2	Brushed matt dark grey metal OPM3	Metal painted in RAL Classic colours OPM8	Brushed copper metal OPM12	Brushed antique brass metal OPM13	Shiny black chrome metal OPM14	Brushed antique gold metal OPM15	Shiny brass chrome metal OPM16	Bronze metal OPM17

Tavoli Tables



7LE101
Server in metallo
Metal server
L64 P25 H51

Top: spessore 5 mm
Base: spessore 10 mm
Metal side table
Top: 5 mm thick
Base: 10 mm thick

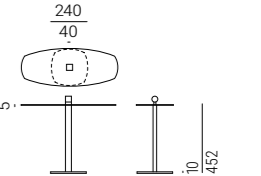

Finiture Finishes

Metallo Metal										
Code	Shiny chrome metal OPM1	Brushed matt chrome metal OPM2	Brushed matt dark grey metal OPM3	RAL 9017 black painted metal OPM6	RAL 9016 white painted metal OPM7	Metal painted in RAL Classic colours OPM8	Classic bronze painted metal OPM9	Golden beach painted metal OPM10	Gold pearl painted metal OPM11	Brushed copper metal OPM12
Code	Brushed antique brass metal OPM13	Shiny black chrome metal OPM14	Brushed antique gold metal OPM15	Shiny brass chrome metal OPM16	Bronze metal OPM17	Anodyc Bronze metal OPM18				

Liam

DESIGN
STUDIO MARELLI
2009

Fusto in legno massello e legno multistrato con cinghie elastiche intrecciate.
Imbottitura in espanso rivestito in vellutino bianco.
Cuscini di schienale in Piumafib, una speciale miscela ipoallergenica di vera piuma e fibra poliestere siliconata*.
Cuscini di seduta in poliuretano espanso con densità di 30 Kg/m³ rivestito in fibre termo legate e in tessuto di puro cotone.
Completamente sfoderabile in tessuto, non sfoderabile in pelle e finta pelle.
Kit letto non disponibile.
*Manutenzione dei cuscini contenenti piuma: I cuscini contenenti piuma tendono a deformarsi con l'utilizzo.
Per mantenerne la forma è necessario, anche dopo un breve utilizzo, battere e sprimacciare ripetutamente i cuscini.
Non utilizzare mai battipanni o aspirapolvere.
A coloro che non desiderassero seguire queste indicazioni o che volessero un divano dall'aspetto meno vissuto, raccomandiamo di preferire dei cuscini in gomma.

Carcasse en bois massif et multiplis muni de bandes élastiques entrecroisées et finie de mousse polyuréthane couverte de dacron.
Coussins de dossier en Piumafib, un mélange hypoallergénique spécial de véritable duvet et fibre polyester siliconisée*.
Coussins d'assise en mousse polyuréthane d'une densité de 30 kg/m³, couverte de dacron.
Revêtement complètement déhoussable en tissu, fixe en cuir et cuir look.
Pas disponible en canapé-lit.
* Entretien de coussins en duvet: Coussins en duvet ont tendance à perdre leur forme dû à l'usage.
Pour en conserver la forme il est nécessaire, aussi après un usage court, de régulièrement battre les coussins. Ne jamais utiliser la tapette ou l'aspirateur.
À ceux qui ne désirent pas suivre ces indications ou qui souhaitent un canapé qui ait l'air moins "usé", nous conseillons vivement de choisir des coussins en mousse polyuréthane.

Frame made of solid wood and multi-ply wood with interwoven elastic straps, upholstered with polyurethane foam, covered with dacron.
The back cushions are filled with Piumafib, a special hypoallergenic mixture of feathers and siliconised polyfibre*.
The seat cushions are made of polyurethane foam with density of 30 Kg/m³, covered with dacron and pure cotton fabric.
Fully removable fabric covers, fixed leather and artificial leather covers.
Sofa-bed is not available.
*Maintenance of feather cushions: Cushions filled with feathers tend to change their shape with use.
In order to keep their shape it is necessary, even after a short use, to plump up the cushions repeatedly.
Never use carpet beater or vacuum cleaner.
We recommend to choose foam cushions to those who do not wish to follow these instructions or to have a "used look" sofa.

Основными преимуществами коллекции диванов Oliver и Slide являются широта и многообразие возможных комбинаций, что обеспечивается богатым выбором элементного ряда, типа наполнения, предлагаемых вариантов отделки, а также видов ножек и оснований и отвечает самым разнообразным требованиям по вкусу, комфорту и параметрам помещения.
Для производства каркаса используется массив дерева и многослойная фанера в сочетании с перекрещивающимися эластичными ремнями.
Наполнение из полиуретана, обернутого в белый бархат. Наполнение подушек спинки выполнено из материала Piumafib – специальной, не вызывающей аллергии смеси из натурального пуха и полиэфирных силиконовых волокон*.
Наполнение подушек сиденья: пенополиуретан плотностью 30 кг/м³, покрытый термосвязанным волокном и обернутый в ткань из натурального хлопка.

Das Gestell besteht aus Massiv- und Schichtholz, mit geflochtenen Gummigurten, gepolstert mit Polyurethanschaumstoff, mit Dacron bezogen.
Rueckenkissen aus Piumafib, einer hypoallergischen speziellen Mischung aus echter Daune und silikonisierter Polyesterfaser*.
Die Sitzkissen bestehen aus Polyurethan-Schaumstoff 30 Kg/m³, bezogen mit Dacron und reinem Baumwollstoff.
Stoffbezüge alle abziehbar, Leder und Kunstleder festbezogen.
Als Bettsofa nicht verfügbare.
*Wartungsanleitungen fuer Daunenkissen: Die Kissen, die Daunen enthalten, neigen dazu, sich durch Gebrauch zu verformen.
Um die urspruengliche Form zu halten, ist es notwendig, auch nach kurzem Gebrauch, die Kissen wiederholt aufzuschueteln.
Keinen Ausklopfen oder Staubsauger verwenden.
Unseren Kunden, die diese Anweisungen nicht befolgen moechten, oder die kein Sofa mit solchem "gebrauchten" Aussehen haben moechten, empfehlen wir Polyurethan-Kissen.

Полностью съемные чехлы из ткани, несъемные чехлы из кожи (искусственной или натуральной) диван-кровать не предоставляется

*Эксплуатация подушек с пуховым наполнением: В процессе эксплуатации подушки с пуховым наполнением могут деформироваться, во избежание чего их необходимо слегка взбивать вручную даже после непродолжительного нахождения на диване. Использование в этих целях пылесоса или выбивалки для одежды категорически запрещено. Если клиент не планирует следовать данным инструкциям и хочет, чтобы подушки сиденья и спинки проминались по минимуму, посоветуйте выбрать наполнение только из полиуретана, полностью исключив натуральный пух.

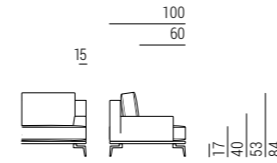

Divani
Sofas

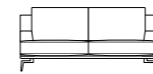

9LI201
L180 P100 H84

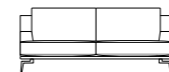

9LI202
L200 P100 H84



9LI203
L220 P100 H84

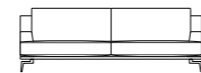

9LI204
L240 P100 H84

Elementi componibili
Modular elements

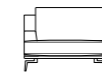

9LI205
L110 P100 H84

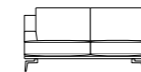

9LI206
L160 P100 H84



9LI207
L180 P100 H84



9LI208
L200 P100 H84



9LI209
L220 P100 H84

Dormeuse
Longchair

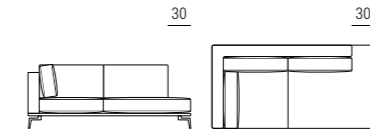

9LI102
L215 P100 H84

Piedini
Feet

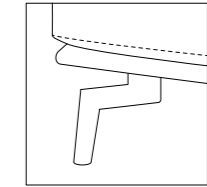

Versione A
in metallo
Version A
in metal

H17 cm

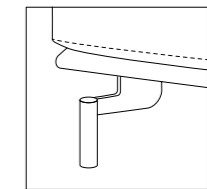

Versione B
in metallo
Version B
in metal

H17 cm

Pouf e accessori
Ottomans and accessories

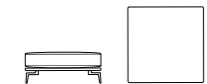

9LI103
L100 P100 H40

Cuscino in piuma
senza fascia
Feather back cushion
without band



9CU106
L45 P45

Piedi in metallo
Metal feet

Metallo
Metal



Code

Shiny chrome metal
OPM1

Brushed matt chrome metal
OPM2

RAL 9017 black painted metal
OPM6

Classic bronze painted metal
OPM9

Golden beach painted metal
OPM10

Gold pearl painted metal
OPM11

Brushed antique gold metal
OPM15

Loft 100

DESIGN
STUDIO MARELLI
2013

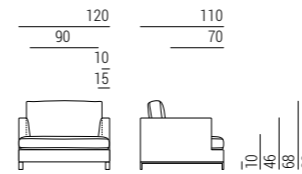
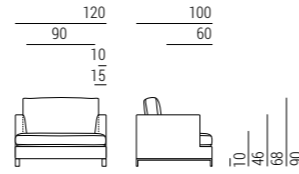

Loft 110

DESIGN
STUDIO MARELLI
2013

Divani
Sofas

Elementi componibili
Modular elements

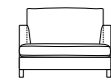

9LT101
L120 P100 H90



9LT102
L105 P100 H90



9LT103
L90 P100 H90

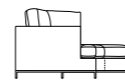
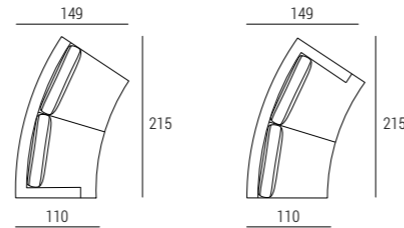

9LT217
L215 P149 H90
Elemento curvo
Curved element

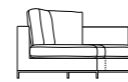

9LT218
L215 P149 H90
Elemento curvo
Curved element

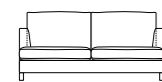

9LT201
L190 P100 H90

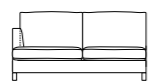

9LT211
L175 P100 H90

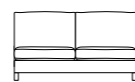

9LT214
L160 P100 H90

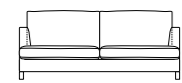

9LT202
L210 P100 H90

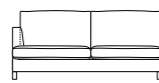

9LT212
L195 P100 H90

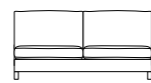

9LT215
L180 P100 H90

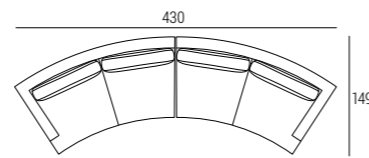

Composizione tipo
Suggested composition

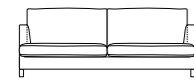

9LT203
L230 P100 H90

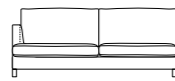

9LT219
L215 P100 H90

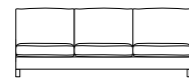

9LT216
L230 P100 H90

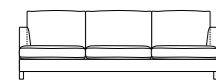

9LT204
L260 P100 H90

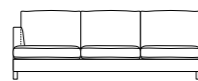

9LT213
L245 P100 H90

Elemento angolare
Corner element

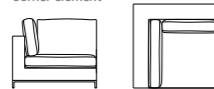

9LT104
L100 P100 H90

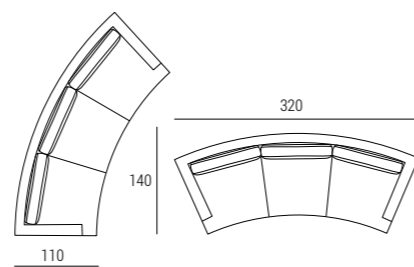

9LT220
L320 P140 H90
Divano curvo
Curved sofa

Divani
Sofas

Elementi componibili
Modular elements

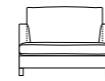

9LJ101
L120 P110 H90



9LJ102
L105 P110 H90



9LJ103
L90 P110 H90

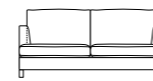
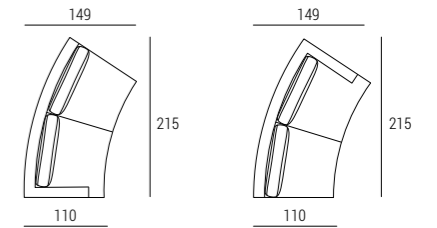

9LJ201
L190 P110 H90

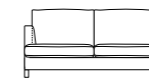

9LJ211
L175 P110 H90

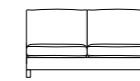

9LJ214
L160 P110 H90



9LT217
L215 P149 H90
Elemento curvo
Curved element

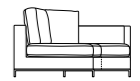

9LT218
L215 P149 H90
Elemento curvo
Curved element

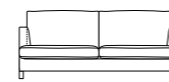

9LJ202
L210 P110 H90

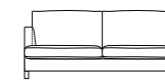

9LJ212
L195 P110 H90

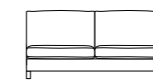

9LJ215
L180 P110 H90

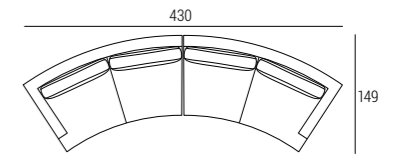

Composizione tipo
Suggested composition

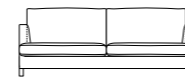

9LJ203
L230 P110 H90

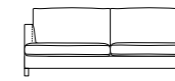

9LJ219
L215 P110 H90

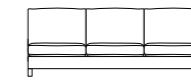

9LJ216
L230 P110 H90

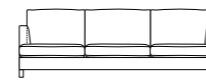

9LJ204
L260 P110 H90

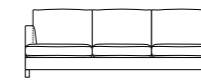

9LJ213
L245 P110 H90

Elemento angolare
Corner element

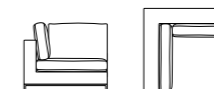

9LJ104
L110 P110 H90

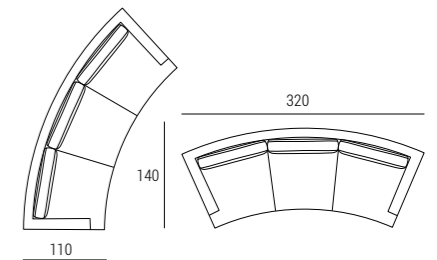

9LT220
L320 P140 H90
Divano curvo
Curved sofa

Le misure delle altezze si riferiscono al modello con base A standard
The height sizes are referred to the model with standard base A

Le misure delle altezze si riferiscono al modello con base A standard
The height sizes are referred to the model with standard base A

Loft 100/110

DESIGN
STUDIO MARELLI
2013

Loft 100/110

DESIGN
STUDIO MARELLI
2013

Dormeuse
Longchair

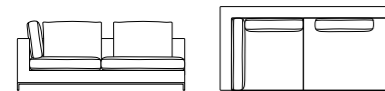

9LT105
L220 P110 H90

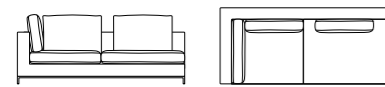

9LT106
L220 P100 H90



9LT112
L115 P140 H90



9LT113
L100 P200 H90

Pouf e accessori
Pouffes and accessories

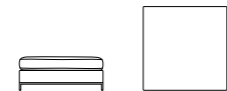

9LT107
L110 P110 H46

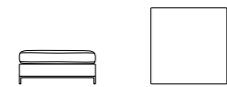

9LT108
L100 P100 H46

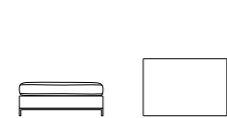

9LT109
L110 P75 H46



9LT110
L100 P75 H46

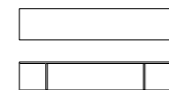

7LT101
L200 P40 H41

Cuscinetto in piuma
senza fascia
*Feather cushion
without band*



Cuscinetto in piuma
senza fascia
*Feather cushion
without band*



Cuscinetto in piuma
senza fascia
*Feather cushion
without band*



Cuscinetto in piuma
senza fascia
*Feather cushion
without band*



Piedini
Feet

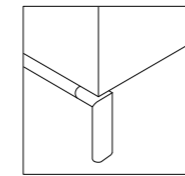

Versione A (standard)
in metallo
Version A (standard)
in metal

H 10 cm

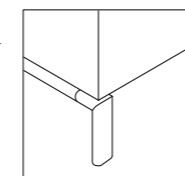

Versione A (optional)
in rovere
Version A (optional)
in oak

H 10 cm

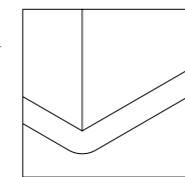

Versione C (optional)
in rovere
Version C (optional)
in oak

H 5 cm

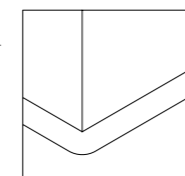

Versione D (optional)
in metallo
Version D (optional)
in metal

H 5 cm

Finiture
Finishes

Versione A + D (standard)
in metallo
Version A + D (standard)
in metal



Shiny chrome metal OPM1	Brushed matt chrome metal OPM2	Brushed matt dark grey metal OPM3	RAL 9017 black painted metal OPM6	Classic bronze painted metal OPM9	Golden beach painted metal OPM10	Gold pearl painted metal OPM11
-----------------------------------	--	---	---	---	--	--

Code

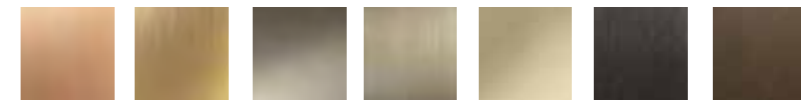

Brushed copper metal OPM12	Brushed antique brass metal OPM13	Shiny black chrome metal OPM14	Brushed antique gold metal OPM15	Shiny brass chrome metal OPM16	Bronze metal OPM17	Anodyc Bronze OPM18
--------------------------------------	---	--	--	--	------------------------------	-------------------------------

Code

Versione A + C + 7LT101 (optional)
in rovere
Version A + C + 7LT101 (optional)
in oak



Cherry stained oak OPR1	Wengé stained oak OPR2	Walnut stained oak OPR3	Natural oak OPR4	Black stained oak OPR5	Cherry Milano stained oak OPR6
-----------------------------------	----------------------------------	-----------------------------------	----------------------------	----------------------------------	--

Code



Tobacco stained oak OPR8	Grey taupe stained oak OPR9	Whitened oak OPR10	Charcoal stained oak OPR11	Mahogany stained oak OPR12	Moka matt stained oak OPR15
------------------------------------	---------------------------------------	------------------------------	--------------------------------------	--------------------------------------	---------------------------------------

Code

Cuciture opzionali
Optional stitchings

Punto Cavallo Stitching



Loft 100/110

DESIGN
STUDIO MARELLI
2013

Fusto in legno massello e legno multistrato con cinghie elastiche intrecciate. Imbottitura in poliuretano espanso rivestito in vellutino bianco. Cuscini di schienale in Piumafib, una speciale miscela ipoallergenica di vera piuma e fibra poliestere siliconata*. Cuscini di seduta costituiti da un inserto in poliuretano con densità di 30 Kg/m³ ricoperto da un trapuntino di vera piuma imbottito a scomparti*. Completamente sfoderabile in tessuto, non sfoderabile in pelle e finta pelle.

Kit letto non disponibile.

Disponibile con profondità di seduta 100/110 cm

*Manutenzione dei cuscini contenenti piuma:

I cuscini contenenti piuma tendono a deformarsi con l'utilizzo. Per mantenerne la forma è necessario, anche dopo un breve utilizzo, battere e sprimacciare ripetutamente i cuscini. Non utilizzare mai battipanni o aspirapolvere. A coloro che non desiderassero seguire queste indicazioni o che volessero un divano dall'aspetto meno vissuto, raccomandiamo di preferire dei cuscini in gomma.

Carcasse en bois massif et multiplis muni de bandes élastiques entrecroisées et finie de mousse polyuréthane couverte de dacron. Coussins de dossier en Piumafib, un mélange hypoallergénique spécial de véritable duvet et fibre polyester siliconisée. Les coussins d'assise sont composés d'un noyau en mousse polyuréthane d'une densité de 30 kg/m³ couvert de véritable duvet broché en compartiments*. Revêtement complètement déhoussable en tissu, fixe en cuir et cuir look. Pas disponible en canapé-lit. Profondeurs d'assise disponibles: cm 100/110 *Entretien de coussins en duvet: Coussins en duvet ont tendance à perdre leur forme dû à l'usage. Pour en conserver la forme il est nécessaire, aussi après un usage court, de régulièrement battre les coussins. Ne jamais utiliser la tapette ou l'aspirateur. À ceux qui ne désirent pas suivre ces indications ou qui souhaitent un canapé qui ait l'air moins "usé", nous conseillons vivement de choisir des coussins en mousse polyuréthane.*

Frame made of solid wood and multi-ply wood with interwoven elastic straps. The upholstery is made of polyurethane foam, covered with dacron. The back cushions are filled with Piumafib, a special hypoallergenic mixture of feathers and siliconised polyfibre. The seat cushions are made of a foam insert with density of 30 Kg/m³, covered with a feather compartments quilt*. Fully removable fabric covers, fixed leather and artificial leather covers. Sofa-bed is not available.*

Available seat depths: 100/110 cm

*Maintenance of feather cushions:

Cushions filled with feathers tend to change their shape with use. In order to keep their shape it is necessary, even after a short use, to plump up the cushions repeatedly. Never use carpet beater or vacuum cleaner. We recommend to choose foam cushions to those who do not wish to follow these instructions or to have a "used look" sofa.

Для производства каркаса используется массив дерева и многослойная фанера в сочетании с перекрещивающимися эластичными ремнями. Наполнение из полиуретана, обернутого в белый бархат. Наполнение подушек спинки выполнено из материала Piumafib – специальной, не вызывающей аллергию смеси из натурального пуха и полиэфирных силиконовых волокон. Подушки сиденья: стеганые по отсекам, наполнение из натурального пуха с вставками из полиуретана плотностью 30 кг/м³ *. Полностью съемные чехлы из ткани, несъемные чехлы из кожи.*

Das Gestell besteht aus Massiv- und Schichtholz, mit geflochtenen Gummigurten, gepolstert mit Polyurethanschaumstoff, mit Dacron bezogen. Rueckenkissen aus Piumafib, einer hypoallergenischen speziellen Mischung aus echter Daune und silikonisierter Polyesterfaser. Die Sitzkissen bestehen aus einem Schaumkern mit Dichte 30 Kg/m³ mit einer gekammerten Daunenauflage*. Stoffbezeuge alle abziehbar, Leder und Kunstleder festbezogen. Als Bettsofa nicht verfügbar.*

Lieferbare Sitztiefen: 100/110 cm

Wartungsanleitungen fuer Daunenkissen:

Die Kissen, die Daunen enthalten, neigen dazu, sich durch Gebrauch zu verformen. Um die urspruengliche Form zu halten, ist es notwendig, auch nach kurzem Gebrauch, die Kissen wiederholt aufzuschuetteln. Keinen Ausklopfen oder Staubsauger verwenden. Unseren Kunden, die diese Anweisungen nicht befolgen moechten, oder die kein Sofa mit solchem "gebrauchten" Aussehen haben moechten, empfehlen wir Polyurethan-Kissen.

Вариант со спальным местом не предусмотрен.

Возможные варианты по глубине: 100/110 см

*Эксплуатация подушек с пуховым наполнением:

В процессе эксплуатации подушки с пуховым наполнением могут деформироваться, во избежание чего их необходимо слегка взбивать вручную даже после непродолжительного нахождения на диване. Использование в этих целях пылесоса или выбивалки для одежды категорически запрещено. Если клиент не планирует следовать данным инструкциям и хочет, чтобы подушки сиденья и спинки проминались по минимуму, посоветуйте выбрать наполнение только из полиуретана, полностью исключив натуральный пух.

Fusto in legno massello e legno multistrato con cinghie elastiche intrecciate. Imbottitura in poliuretano espanso rivestito in vellutino bianco. Cuscini di schienale in Piumafib, una speciale miscela ipoallergenica di vera piuma e fibra poliestere siliconata*. Cuscini di seduta costituiti da un inserto in poliuretano con densità di 30 Kg/m³ ricoperto da un trapuntino di vera piuma imbottito a scomparti*. Completamente sfoderabile in tessuto, non sfoderabile in pelle e finta pelle. Kit letto non disponibile. *Manutenzione dei cuscini contenenti piuma: I cuscini contenenti piuma tendono a deformarsi con l'utilizzo. Per mantenerne la forma è necessario, anche dopo un breve utilizzo, battere e sprimacciare ripetutamente i cuscini. Non utilizzare mai battipanni o aspirapolvere. A coloro che non desiderassero seguire queste indicazioni o che volessero un divano dall'aspetto meno vissuto, raccomandiamo di preferire dei cuscini in gomma.

Carcasse en bois massif et multiplis muni de bandes élastiques entrecroisées et finie de mousse polyuréthane couverte de dacron. Coussins de dossier en Piumafib, un mélange hypoallergénique spécial de véritable duvet et fibre polyester siliconisée. Les coussins d'assise sont composés d'un noyau en mousse polyuréthane d'une densité de 30 kg/m³ couvert de véritable duvet broché en compartiments*. Revêtement complètement déhoussable en tissu, fixe en cuir et cuir look. Pas disponible en canapé-lit. *Entretien de coussins en duvet: Coussins en duvet ont tendance à perdre leur forme dû à l'usage. Pour en conserver la forme il est nécessaire, aussi après un usage court, de régulièrement battre les coussins. Ne jamais utiliser la tapette ou l'aspirateur. À ceux qui ne désirent pas suivre ces indications ou qui souhaitent un canapé qui ait l'air moins "usé", nous conseillons vivement de choisir des coussins en mousse polyuréthane.*

Frame made of solid wood and multi-ply wood with interwoven elastic straps. The upholstery is made of polyurethane foam, covered with dacron. The back cushions are filled with Piumafib, a special hypoallergenic mixture of feathers and siliconised polyfibre. The seat cushions are made of a foam insert with density of 30 Kg/m³, covered with a feather compartments quilt*. Fully removable fabric covers, fixed leather and artificial leather covers. Sofa-bed is not available. *Maintenance of feather cushions: Cushions filled with feathers tend to change their shape with use. In order to keep their shape it is necessary, even after a short use, to plump up the cushions repeatedly. Never use carpet beater or vacuum cleaner. We recommend to choose foam cushions to those who do not wish to follow these instructions or to have a "used look" sofa.*

Для производства каркаса используется массив дерева и многослойная фанера в сочетании с перекрещивающимися эластичными ремнями. Наполнение из полиуретана, обернутого в белый бархат. Наполнение подушек спинки выполнено из материала Piumafib – специальной, не вызывающей аллергию смеси из натурального пуха и полиэфирных силиконовых волокон. Подушки сиденья: стеганые по отсекам, наполнение из натурального пуха с вставками из полиуретана плотностью 30 кг/м³ *. Полностью съемные чехлы из ткани, несъемные чехлы из кожи. Вариант со спальным местом не предусмотрен.*

Das Gestell besteht aus Massiv- und Schichtholz, mit geflochtenen Gummigurten, gepolstert mit Polyurethanschaumstoff, mit Dacron bezogen. Rueckenkissen aus Piumafib, einer hypoallergenischen speziellen Mischung aus echter Daune und silikonisierter Polyesterfaser. Die Sitzkissen bestehen aus einem Schaumkern mit Dichte 30 Kg/m³ mit einer gekammerten Daunenauflage*. Stoffbezeuge alle abziehbar, Leder und Kunstleder festbezogen. Als Bettsofa nicht verfügbar. Wartungsanleitungen fuer Daunenkissen: Die Kissen, die Daunen enthalten, neigen dazu, sich durch Gebrauch zu verformen. Um die urspruengliche Form zu halten, ist es notwendig, auch nach kurzem Gebrauch, die Kissen wiederholt aufzuschuetteln. Keinen Ausklopfen oder Staubsauger verwenden. Unseren Kunden, die diese Anweisungen nicht befolgen moechten, oder die kein Sofa mit solchem "gebrauchten" Aussehen haben moechten, empfehlen wir Polyurethan-Kissen.*

**Эксплуатация подушек с пуховым наполнением: В процессе эксплуатации подушки с пуховым наполнением могут деформироваться, во избежание чего их необходимо слегка взбивать вручную даже после непродолжительного нахождения на диване. Использование в этих целях пылесоса или выбивалки для одежды категорически запрещено. Если клиент не планирует следовать данным инструкциям и хочет, чтобы подушки сиденья и спинки проминались по минимуму, посоветуйте выбрать наполнение только из полиуретана, полностью исключив натуральный пух.*

Matheus

DESIGN
STUDIO MARELLI
2015

Matheus

DESIGN
STUDIO MARELLI
2015

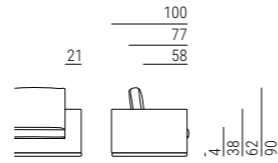

Divani
Sofas

Elementi componibili
Modular elements

9MU201 L180 P100 H62

9MU202 L200 P100 H62

9MU203 L220 P100 H62

9MU204 L240 P100 H62

9MU205 L260 P100 H62

9MU206 L160 P100 H62

9MU207 L180 P100 H62

9MU208 L200 P100 H62

9MU209 L220 P100 H62

9MU210 L240 P100 H62

9MU212 L140 P100 H62

9MU213 L160 P100 H62

9MU214 L180 P100 H62

9MU215 L200 P100 H62

9MU216 L100 P100 H62
Elemento angolare
Corner element

9MU217 L190 P190 H62
Divano curvo
Curved sofa

9MU218 L145 P109 H62
Divano curvo
Curved sofa

9MU219 L190 P190 H62
Divano curvo
Curved sofa

9MU220 L80 P100 H62

9MU221 L80 P100 H38

Composizioni tipo
Suggested compositions

376

255

540

280

Matheus

DESIGN
STUDIO MARELLI
2015

Dormeuse
Longchair

Pouf e accessori
Pouf and accessories

9MU105 L200 P100 H62

9MU110 L200 P100 H62

9MU108 L225 P100 H62

9MU114 L100 P100 H38

9MU116 L72 H60

9CU106 L45 P45

9MU101 L50 P50

9MU102 L60 P60

9CUT106 L45 P45

9MU103 L50 P50

9MU104 L60 P60

Poggia cuscino di schienale
Backrest cushion support

Cuscino in piuma senza fascia
Feather back cushion without band

Cuscino per schienale in piuma con fascia
Feather back cushion with band

Cuscino per schienale trapuntato in piuma con fascia
Quilted feather back cushion with band

Cuscino in piuma trapuntato senza fascia
Quilted feather cushion without band

Cuscino per schienale trapuntato in piuma con fascia
Quilted feather back cushion with band

55

55

45

45

Finiture base metallo
Metal base finishes

Code	Shiny chrome metal OPM1	Brushed matt chrome metal OPM2	Brushed matt dark grey metal OPM3	RAL 9017 black painted metal OPM6	Classic bronze painted metal OPM9	Golden beach painted metal OPM10	Gold pearl painted metal OPM11	Brushed copper metal OPM12
Code	Brushed antique brass metal OPM13	Shiny black chrome metal OPM14	Brushed antique gold metal OPM15	Shiny brass chrome metal OPM16	Bronze metal OPM17	Anodized bronze metal OPM18		

Mike

DESIGN
STUDIO MARELLI
2015

Telaio in metallo verniciato nero o bianco. Gambe in tubo di metallo rivestito in rovere massello. Sottopiano portante in HPL, su cui viene fissato il top.

Piètement en métal laqué noir ou blanc. Pieds en tube de métal revêtu de chêne massif. Sousstructure portante en HPL, sur laquelle est fixé le plateau.

Table frame in black or white painted metal. Metal tube legs covered with solid oak wood. Underlying supporting surface in HPL, on which the top is fixed.

Металлический каркас, окрашенный в черный либо белый цвет. Ножки из металлической трубы в сочетании с массивом дуба. Столешница крепится на несущую подложку из ламината высокого давления (HPL, "High Pressure Laminate")

Das Tischgestell besteht aus Metall, schwarz oder weiss lackiert. Metallgestell mit Eiche Echtholz furniert. Die Tischplatte ist mit einer HPL-Platte unterlegt.

Mike

DESIGN
STUDIO MARELLI
2015

Tavoli Tables

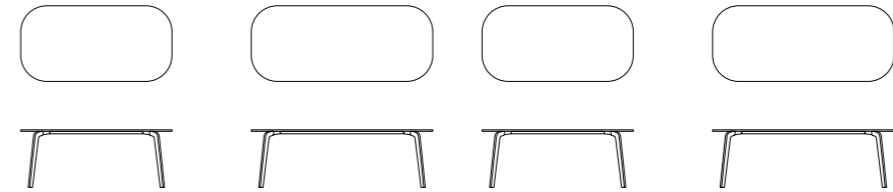

7MK101
Top in marmo
Marble top
L200 P100 H73

7MK102
Top in marmo / Marble top
L240 P100 H73

7MK103
Top in legno
Wooden top
L200 P100 H73

7MK104
Top in legno
Wooden top
L240 P100 H73

Top: marmo, spessore 20 mm
Top: marble, 20 mm thick



Finiture Finishes

Top in marmo
Marble top

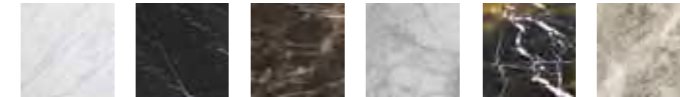

Code
White Carrara marble **OPP1** Black Marquinia marble **OPP2** Brown Emperador marble **OPP3** Calacatta gold marble **OPP7** Black and gold marble **OPP9** Peretto brown marble **OPP10**



Code
Grey Stone marble **OPP11** Guatemala green marble **OPP12** Velvet brown marble **OPP13** Amani Bronze marble **OPP14** Covelano white marble **OPP15**

Top in Gres Porcellanato
Porcelain Stoneware Top



Code
Carrara Pure **OPG1** Nero Marquinia **OPG2** Statuario Select **OPG3** Calacatta Royal **OPG4**

Top/base in legno
Wooden base/top



Code
Cherry stained oak **OPR1** Wengé stained oak **OPR2** Walnut stained oak **OPR3** Natural oak **OPR4** Black stained oak **OPR5** Cherry Milano stained oak **OPR6**



Code
Tobacco stained oak **OPR8** Grey taupe stained oak **OPR9** Whitened oak **OPR10** Charcoal stained oak **OPR11** Mahogany stained oak **OPR12** Oak painted in RAL Classic colours **OPR14** Moka matt stained oak **OPR15**

Mini

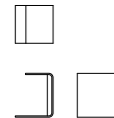
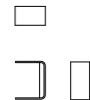
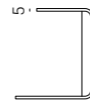
DESIGN
STUDIO MARELLI
2009Tavoli
Tables**9TX159**
L50 P36 H58**9TX160**
L25 P40 H50Server in metallo, spessore 5 mm
Server table in metal, 5 mm thickFiniture
FinishesMetallo
Metal

Code

Shiny chrome metal **OPM1** | Brushed matt chrome metal **OPM2** | Brushed matt dark grey metal **OPM3** | RAL 9017 black painted metal **OPM6** | RAL 9016 white painted metal **OPM7** | Metal painted in RAL Classic colors **OPM8** | Classic bronze painted metal **OPM9**



Code

Golden beach painted metal **OPM10** | Gold pearl painted metal **OPM11** | Brushed copper metal **OPM12** | Brushed antique brass metal **OPM13** | Brushed antique gold metal **OPM15** | Anodized Bronze metal **OPM18**

Moon

DESIGN
STUDIO MARELLI
2019

Fusto in legno massello e legno multistrato con cinghie elastiche intrecciate.
Imbottitura della seduta in poliuretano espanso con densità 40 kg/m³ rivestito in dacron.
Imbottitura dello schienale in poliuretano espanso a quote differenziate con densità di 30 kg/m³ e 40 kg/m³, rivestito in dacron.
Rivestimento fisso.

Carcasse en bois massif et multiplis munie de bandes élastiques entrecroisées.
Assise rembourrée en mousse de polyuréthane d'une densité de 40 kg/m³ couverte de dacron.
Dossier rembourré en mousse polyuréthane de différentes densités de 30 kg/m³ et 40 kg/m³ couverte de dacron.
Revêtement fixe.

Frame made of solid wood and plywood with interwoven elastic belts.
Seat upholstered with polyurethane foam with density of 40 kg/m³, covered with dacron.
Back upholstered with polyurethane foam with different densities of 30 kg/m³ and 40 kg/m³, covered with dacron.
Fixed covers.

Для производства каркаса используется массив дерева и многослойная фанера в сочетании с перекрещивающимися эластичными ремнями. Наполнение сиденья из вспененного пенополиуретан плотностью - 30 кг/м³, обернутого в дакрон. Наполнение спинки из вспененного пенополиуретана различной степени плотности - 30 кг/м³ и 40 кг/м³, обернутого в дакрон. Чехлы несъемные.

Das Gestell besteht aus Massiv- und Schichtholz, mit geflochtenen Gummigurten.
Sitz gepolstert mit Polyurethan-Schaumstoff 40 Kg/m³, mit Dacron bezogen.
Rücken gepolstert mit Polyurethan-Schaumstoff in verschiedenen Dichten 30 Kg/m³ und 40 Kg/m³, mit Dacron bezogen.
Ribot ist immer festbezogen.

Moon

DESIGN
STUDIO MARELLI
2019

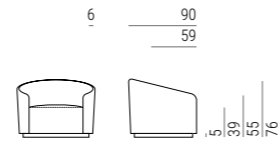

New York

DESIGN
STUDIO MARELLI
2015

Divani
Sofas

Pouf e accessori
Ottomans and accessories

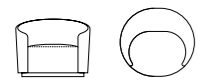

9MN101
L98 P90 H76

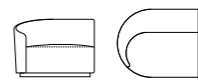

9MN206
L106 P90 H76

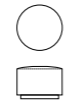
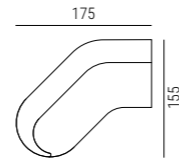

9MN102
Ø60 H40

Cuscino in piuma
senza fascia
Feather back cushion
without band

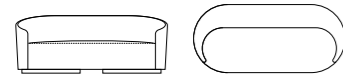

9MN201
L200 P90 H76

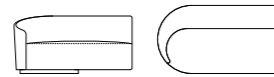

9MN207
L156 P90 H76

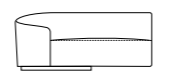

9MN205
L155 P175 H76



9CU106
L45 P45

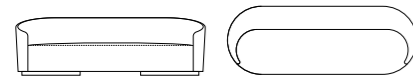

9MN202
L250 P90 H76

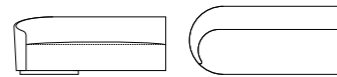

9MN208
L201 P90 H76



9MN203
L245 P120 H76

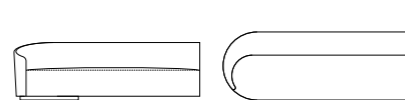

9MN209
L246 P90 H76



9MN204
L305 P120 H76

Fusto in legno massello e legno multistrato con cinghie elastiche intrecciate.
Imbottitura in poliuretano espanso con densità 40 Kg/m³ rivestito in dacron.
Seduta e schienale in poliuretano espanso con densità di 30 Kg/m³, rivestito in dacron.
Cuscini di schienale in piuma.
Rivestimento non sfoderabile né in tessuto, né in pelle e finta pelle. Kit letto non disponibile.

Carcasse en bois massif et multiplis muni de bandes élastiques entrecroisées et finie de mousse de polyuréthane d'une densité de 40 kg/m³ couverte de dacron.
Assise et dossier en mousse de polyuréthane d'une densité de 30 kg/m³, couverte de dacron.
Coussins de dossier en plumes.
Le revêtement est toujours fixe.
Pas disponible en canapé-lit.

Frame made of solid wood and multi-ply wood with interwoven elastic straps, upholstered with polyurethane foam with density of 40 Kg/m³, covered with dacron.
Seat and back in polyurethane foam with density of 30 Kg/m³, covered with dacron.
Feather back cushions.
Fixed fabric, leather and artificial leather covers.
Sofa-bed is not available.

Для производства каркаса используется массив дерева и многослойная фанера в сочетании с перекрещивающимися эластичными ремнями.
Наполнение из вспененного полиуретана плотностью 40 кг/м³, обернутого в дакрон.
Наполнение спинки и сиденья: вспененный пенополиуретан плотностью 30 кг/м³, обернутый в дакрон.
Наполнение подушек спинки: пух.
Чехля несъемные независимо от варианта обивки (ткань, кожа, искусственная кожа)
Версия со спальным местом не предусмотрена

Das Gestell besteht aus Massiv- und Schichtholz, mit geflochtenen Gummigurten, gepolstert mit Polyurethan-Schaumstoff 40 Kg/m³, mit Dacron ummantelt.
Sitz und Rücken bestehen aus Polyurethan-Schaumstoff 30 Kg/m³, mit Dacron ummantelt.
Rückenkissen in Daune.
New York ist immer festbezogen.
Als Bettsofa nicht verfügbar.

Finiture
Finishes

Base metallo
Metal base



Code

Shiny chrome metal **OPM1**
Brushed matt chrome metal **OPM2**
Brushed matt dark grey metal **OPM3**
RAL 9017 black painted metal **OPM6**
Classic bronze painted metal **OPM9**



Code

Golden beach painted metal **OPM10**
Gold pearl painted metal **OPM11**
Brushed copper metal **OPM12**
Brushed antique brass metal **OPM13**
Shiny black chrome metal **OPM14**
Brushed antique gold metal **OPM15**
Shiny brass chrome metal **OPM16**
Bronze metal **OPM17**
Anodyc Bronze painted metal **OPM18**

New York

DESIGN
STUDIO MARELLI
2015

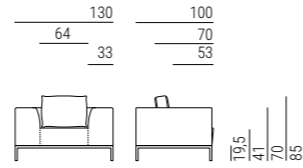

New York

DESIGN
STUDIO MARELLI
2015

Divani
Sofas

Elementi componibili
Modular elements

Pouf e accessori
Ottomans and accessories

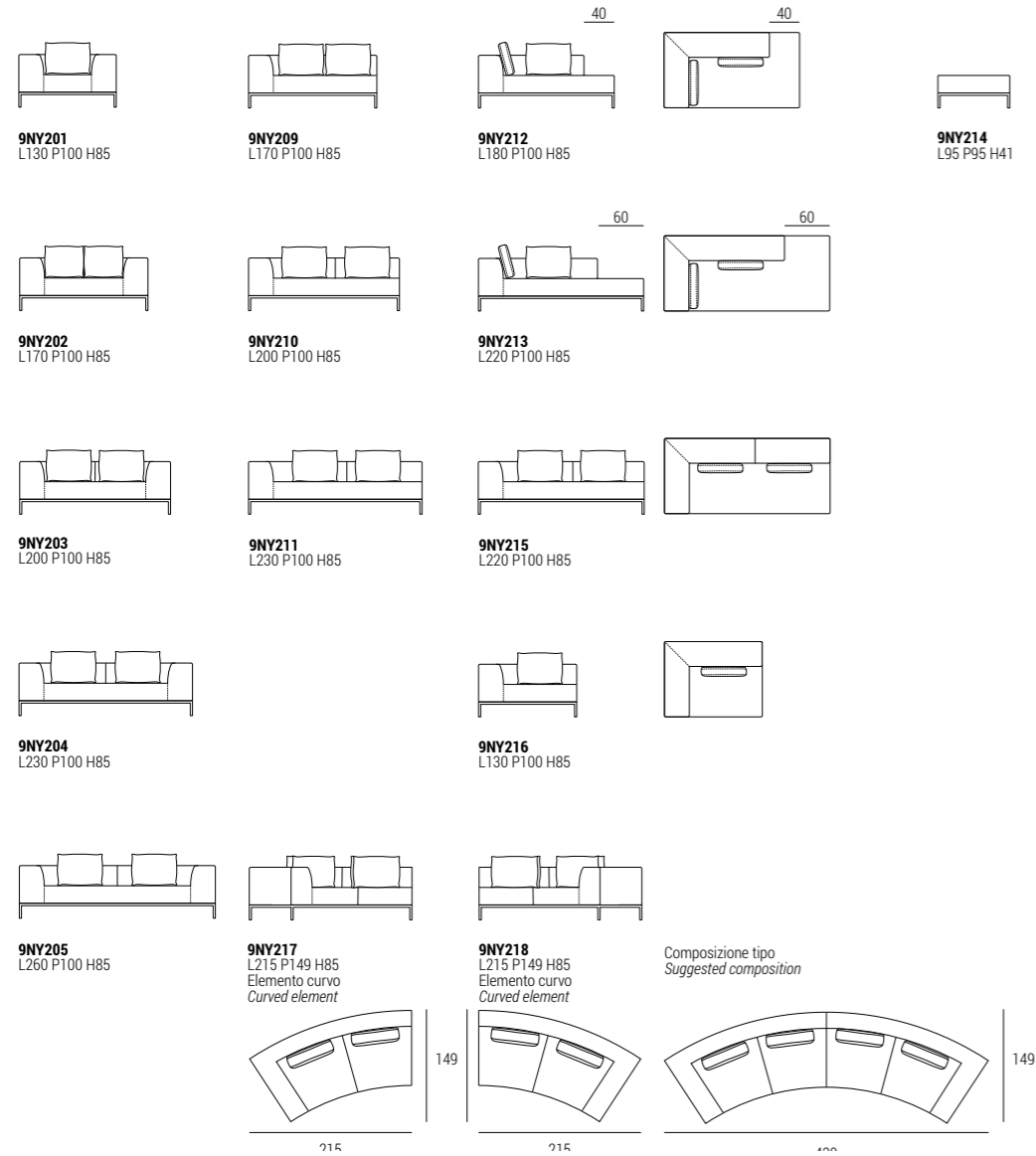

Finiture
Finishes

Base in metallo Metal base							
Code	Shiny chrome metal OPM1	Brushed matt chrome metal OPM2	Brushed matt dark grey metal OPM3	RAL 9017 black painted metal OPM6	Classic bronze painted metal OPM9	Golden beach painted metal OPM10	Gold pearl painted metal OPM11
Code							
Code	Brushed copper metal OPM12	Brushed antique brass metal OPM13	Shiny black chrome metal OPM14	Brushed antique gold metal OPM15	Shiny brass chrome metal OPM16	Bronze metal OPM17	Anodyc Bronze painted metal OPM18

Nicole

DESIGN
STUDIO MARELLI
2015

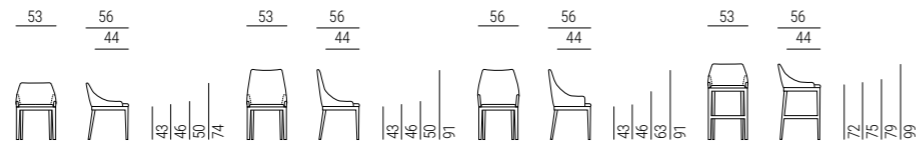

Fusto in legno multistrato di pioppo curvato. Struttura della seduta in legno multistrato con imbottitura in poliuretano espanso a quote differenziate 30 kg/m³ e 40 kg/m³, rivestito in dacron, con cinghie elastiche intrecciate. Rivestimento fisso.

La versione standard è dotata di antiscivolanti in PVC. Disponibili a richiesta altri tipi di antiscivolanti, in feltro e plastica.

Carcasse en bois multiplis de peuplier courbé. Structure de l'assise en bois multiplis finie de mousse de polyuréthane de différentes densités de 30 kg/m³ et de 40 kg/m³ couverte de dacron, muni de bandes élastiques entrecroisées.

Revêtement fixe. Equipé de patins en PVC dans la version standard. Disponible sur demande avec d'autres patins, en feutre ou en plastique.

Frame made of curved multi-ply poplar wood. Seat structure made of multi-ply wood, upholstered with polyurethane foam in different densities of 30 Kg/m³ and 40 Kg/m³, covered with dacron, with interwoven elastic belts.

Fixed covers. The standard version is equipped with PVC glides. Other kinds of glides in plastic or felt pads are available on demand.

Для производства каркаса используется гнутая многослойная фанера из тополя. Конструкция сиденья выполнена из многослойной фанеры в сочетании с перекрещивающимися эластичными ремнями и наполнением из вспененного пенополиуретана различной степени плотности - 30 кг/м³ и 40 кг/м³, обернутого в дакрон. Чехлы несъемные.

В стандартный комплект по умолчанию входят противоскользящие накладки из ПВХ. По запросу возможно их изготовление из войлока или пластика.

Das Gestell besteht aus gebogenem Pappelschichtholz. Sitzstruktur aus Schichtholz, gepolstert mit Polyurethan-Schaumstoff in verschiedenen Dichten 30 Kg/m³ und 40 Kg/m³, mit Dacron ummantelt, mit geflochtenen Gummigurten.

Nicole ist immer festbezogen. Standard mit PVC-Gleitern ausgestattet. Andere Gleiter, wie Felz- oder Kunststoffgleiter, sind auf Anfrage verfügbar.

Schienale in legno multistrato di pioppo curvato imbottito con poliuretano espanso con densità 30 kg/ m³. Seduta in legno multistrato di pioppo imbottito con poliuretano espanso 40 kg/m³, rivestito in dacron con cinghie elastiche intrecciate. Disponibile con trapuntatura sulla parte interna dello schienale oppure liscia. Rivestimento fisso. Basamento in rovere nelle finiture standard o rivestito in tessuto o pelle. La versione standard è dotata di antiscivolanti in PVC. Disponibili a richiesta altri tipi di antiscivolanti, in feltro e plastica.

Backrest made of curved multi-ply poplar wood, upholstered with polyurethane foam with density 30 kg/ m³. Seat structure made of multi-ply poplar wood, upholstered with polyurethane foam with density of 40 Kg/m³, covered with dacron, with interwoven elastic belts. Available with or without quilted inner side. Fixed covers. Oak base in the standard finishes or covered with fabric or leather. The standard version is equipped with PVC glides. Other kinds of glides in plastic or felt pads are available on demand.

Rückenlehne aus aus gebogenem Pappelschichtholz, gepolstert mit Polyurethan-Schaumstoff mit Dichte 30 Kg/m³. Sitzstruktur aus Pappelschichtholz, gepolstert mit Polyurethan-Schaumstoff mit Dichte 40 Kg/m³, mit Dacron ummantelt, mit geflochtenen Gummigurten. Verfügbar mit oder ohne abgesteppte Innenseite. Paris ist immer festbezogen. Eichengestell in den Standard-Ausführungen oder mit Stoff oder Leder bezogen. Standard mit PVC-Gleitern ausgestattet. Andere Gleiter, wie Felz- oder Kunststoffgleiter, sind auf Anfrage verfügbar.

Dossier en bois multiplis de peuplier courbé fini de mousse de polyuréthane de densité de 30 kg/m³. Structure de l'assise en bois multiplis de peuplier finie de mousse de polyuréthane de densité de 40 kg/m³ couverte de dacron, muni de bandes élastiques entrecroisées. Disponible avec ou sans côté intérieur matelassé. Revêtement fixe. Piètement en chêne dans les finitions standard ou recouvert de tissu ou cuir. Equipé de patins en PVC dans la version standard. Disponible sur demande avec d'autres patins, en feutre ou en plastique.

Для изготовления спинки используется гнутая многослойная фанера из тополя с наполнением из вспененного полиуретана плотностью 30 кг/м³. Конструкция сиденья: многослойная фанера из тополя с наполнением из вспененного полиуретана плотностью 40 кг/м³, обернутого в дакрон, в сочетании с перекрещивающимися эластичными ремнями. Для внутренней части спинки предусмотрено 2 варианта отделки: гладкая, либо с декоративной простежкой. Обивка несъемная. Основание стула выполнено из дуба в стандартных цветах, либо в коже или ткани. В стандартный комплект по умолчанию входят противоскользящие накладки из ПВХ. По запросу возможно их изготовление из войлока или пластика.

Sedie e Sgabello Chairs and Barstool

Con schienale esterno trapuntato
With quilted outer backrest



9NK101
L53 P56 H91



9NK102
L53 P56 H74



9NK111
L53 P56 H91



9NK112
L53 P56 H74



9NK103
L56 P56 H91



9NK104
L53 P56 H99



9NK113
L56 P56 H91



9NK114
L53 P56 H99

Finiture Finishes

Base in legno
Wooden base



Code

Cherry stained oak **OPR1** Wengé stained oak **OPR2** Walnut stained oak **OPR3** Natural oak **OPR4** Black stained oak **OPR5** Cherry Milano stained oak **OPR6**

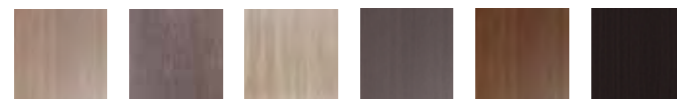

Code

Tobacco stained oak **OPR8** Grey taupe stained oak **OPR9** Whitened oak **OPR10** Charcoal stained oak **OPR11** Mahogany stained oak **OPR12** Moka matt stained oak **OPR15**

Base in rovere rivestita in tessuto/pelle
Oak base covered in fabric/leather

Paris

DESIGN
ELEONORA POZZI
2016

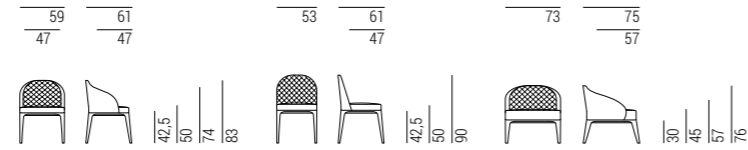

Paris

DESIGN
ELEONORA POZZI
2016

Divani
Sofas



Il modello Paris è disponibile a richiesta con trapuntatura anche sulla parte esterna dello schienale.
On demand Paris is available also with quilting on the external side of the backrest.

Finiture
Finishes

Base in legno Wooden base						
Code	Cherry stained oak OPR1	Wengé stained oak OPR2	Walnut stained oak OPR3	Natural oak OPR4	Black stained oak OPR5	Cherry Milano stained oak OPR6
Code	Tobacco stained oak OPR8	Grey taupe stained oak OPR9	Whitened oak OPR10	Charcoal stained oak OPR11	Mahogany stained oak OPR12	Moka matt stained oak OPR15
Base in rovere rivestita in tessuto/pelle Oak base covered in fabric/leather						

Cuciture opzionali
Optional stitchings













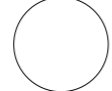

X Stitching

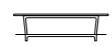
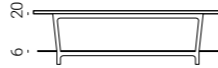
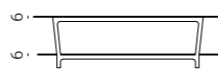

Tab

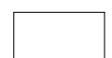
DESIGN
PAOLO SALVADÉ
2014

















































Tavoli
Tables

				<p>Piano superiore: marmo, spessore 20 mm Piano inferiore: legno impiallacciato noce Canaletto o rovere, spessore 20 mm Struttura: metallo, sezione 10 mm Upper top: marble, 20 mm thick Lower top: Canaletto walnut or oak veneer, 20 mm thick Structure: metal, section 10 mm</p> 
				
<p>7TAB101 Piano superiore in marmo Piano inferiore in legno Marble upper top Wooden lower top</p>	<p>7TAB102 Piano superiore in marmo Piano inferiore in legno Marble upper top Wooden lower top</p>	<p>7TAB103 Piano superiore in marmo Piano inferiore in legno Marble upper top Wooden lower top</p>	<p>7TAB104 Piano superiore in marmo Piano inferiore in legno Marble upper top Wooden lower top</p>	
<p>7TAB111 Piano superiore in marmo Piano inferiore in vetro Marble upper top Glass lower top</p>	<p>7TAB112 Piano superiore in marmo Piano inferiore in vetro Marble upper top Glass lower top</p>	<p>7TAB113 Piano superiore in marmo Piano inferiore in vetro Marble upper top Glass lower top</p>	<p>7TAB114 Piano superiore in marmo Piano inferiore in vetro Marble upper top Glass lower top</p>	
<p>7TAB121 Piano superiore e inferiore in vetro Glass lower and upper top</p> <p>Ø60 H36</p>	<p>7TAB122 Piano superiore e inferiore in vetro Glass lower and upper top</p> <p>Ø60 H50</p>	<p>7TAB123 Piano superiore e inferiore in vetro Glass lower and upper top</p> <p>Ø90 H36</p>	<p>7TAB124 Piano superiore e inferiore in vetro Glass lower and upper top</p> <p>Ø125 H36</p>	<p>Piano superiore: marmo, spessore 20 mm Piano inferiore: vetro temperato extra light, spessore 6 mm Struttura: metallo, sezione 10 mm Upper top: marble, 20 mm thick Lower top: extralight tempered glass, 6 mm thick Structure: metal, section 10 mm</p>  <p>Piano superiore: vetro temperato extra light, spessore 6 mm Piano inferiore: vetro temperato extra light, spessore 6 mm Struttura: metallo, sezione 10 mm Upper top: extralight tempered glass, 6 mm thick Lower top: extralight tempered glass, 6 mm thick Structure: metal, section 10 mm</p> 
				
				
<p>7TAB105 Piano superiore in marmo Piano inferiore in legno Marble upper top Wooden lower top</p>	<p>7TAB106 Piano superiore in marmo Piano inferiore in legno Marble upper top Wooden lower top</p>	<p>7TAB107 Piano superiore in marmo Piano inferiore in legno Marble upper top Wooden lower top</p>	<p>7TAB108 Piano superiore in marmo Piano inferiore in legno Marble upper top Wooden lower top</p>	
<p>7TAB115 Piano superiore in marmo Piano inferiore in vetro Marble upper top Glass lower top</p>	<p>7TAB116 Piano superiore in marmo Piano inferiore in vetro Marble upper top Glass lower top</p>	<p>7TAB117 Piano superiore in marmo Piano inferiore in vetro Marble upper top Glass lower top</p>	<p>7TAB118 Piano superiore in marmo Piano inferiore in vetro Marble upper top Glass lower top</p>	
<p>7TAB125 Piano superiore e inferiore in vetro Glass lower and upper top</p> <p>L65 P65 H36</p>	<p>7TAB126 Piano superiore e inferiore in vetro Glass lower and upper top</p> <p>L90 P90 H36</p>	<p>7TAB127 Piano superiore e inferiore in vetro Glass lower and upper top</p> <p>L127 P54 H36</p>	<p>7TAB128 Piano superiore e inferiore in vetro Glass lower and upper top</p> <p>L120 P70 H36</p>	

Tab

DESIGN
PAOLO SALVADÉ
2014











Finiture
Finishes

Top in marmo Marble top								
Code	White Carrara marble OPP1	Black Marquina marble OPP2	Brown Emperador marble OPP3	Calacatta gold marble OPP7	Black and gold marble OPP9	Perfetto brown marble OPP10		
Code								
Code	Grey Stone marble OPP11	Guatemala green marble OPP12	Velvet brown marble OPP13	Amani Bronze marble OPP14	Covelano white marble OPP15			
Top in Gres Porcellanato Porcelain Stoneware Top								
Code	Carrara Pure OPG1	Nero Marquina OPG2	Statuario Select OPG3	Calacatta Royal OPG4				
Top in vetro Glass top								
Code	RAL 9016 traffic white back-painted glass OPV3	RAL 9017 traffic black back-painted glass OPV4	RAL 7044 silk grey back-painted glass OPV5	RAL 1019 grey beige back-painted glass OPV6	Chrome back-painted bronze glass OPV9	Chrome back-painted grey glass OPV10	Transparent bronze glass OPV12	Transparent grey glass OPV13
Top rovere Oak top								
Code	Cherry stained oak OPR1	Wengé stained oak OPR2	Walnut stained oak OPR3	Natural oak OPR4	Black stained oak OPR5	Cherry Milano stained oak OPR6		
Code								
Code	Tobacco stained oak OPR8	Grey taupe stained oak OPR9	Whitened oak OPR10	Charcoal stained oak OPR11	Mahogany stained oak OPR12	Moka matt stained oak OPR15		
Struttura in metallo Metal structure								
Code	Shiny chrome metal OPM1	Brushed matt chrome metal OPM2	Brushed matt dark grey metal OPM3	Classic bronze painted metal OPM9	Golden beach painted metal OPM10	Gold pearl painted metal OPM11		
Code								
Code	Brushed copper metal OPM12	Brushed antique brass metal OPM13	Shiny black chrome metal OPM14	Brushed antique gold metal OPM15	Shiny brass chrome metal OPM16	Bronze metal OPM17	Anodized Bronze metal OPM18	

Thor

DESIGN
STUDIO MARELLI
2018

















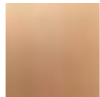





Tavoli
Tables

					
					
7TH101 Tavolo in marmo Marble table L80 P80 H19	7TH102 Tavolo in marmo Marble table L100 P100 H19	7TH111 Tavolo in marmo con base metallo Marble table with metal base L80 P80 H27	7TH112 Tavolo in marmo con base metallo Marble table with metal base L100 P100 H27		
7TH103 Tavolo in marmo Marble table L40 P40 H40	7TH104 Tavolo in marmo Marble table L50 P50 H50	7TH105 Tavolo in marmo Marble table L60 P60 H19	7TH115 Tavolo in marmo con base metallo Marble table with metal base L60 P60 H27	7TH106 Tavolo in marmo Marble table L60 P110 H19	7TH116 Tavolo in marmo con base metallo Marble table with metal base L60 P110 H27

Thor

DESIGN
STUDIO MARELLI
2018

Finiture
Finishes

Base in metallo Metal base						
Code	Shiny chrome metal OPM1	Brushed matt chrome metal OPM2	Brushed matt dark grey metal OPM3	Classic bronze painted metal OPM9	Golden beach painted metal OPM10	Gold pearl painted metal OPM11
						
Code	Brushed copper metal OPM12	Brushed antique brass metal OPM13	Shiny black chrome metal OPM14	Brushed antique gold metal OPM15	Shiny brass chrome metal OPM16	Bronze metal OPM17
Marmo Marble						
Code	White Carrara marble OPP1	Black Marquina marble OPP2	Brown Emperador marble OPP3	Calacatta gold marble OPP7	Black and gold marble OPP9	Perfetto brown marble OPP10
						
Code	Grey Stone marble OPP11	Guatemala green marble OPP12	Velvet brown marble OPP13	Amani Bronze marble OPP14	Covelano white marble OPP15	

Tom

DESIGN
STUDIO MARELLI
2014

Twig
DESIGN
ELEONORA POZZI
2017

Tavoli
Tables



7TM101
Tavolino in tulipier tinto
Stained tulipier table
7TM111
Tavolino in tulipier verniciato lucido
Polished painted tulipier table
Ø40 H40

7TM102
Tavolino in tulipier tinto
Stained tulipier table
7TM112
Tavolino in tulipier verniciato lucido
Polished painted tulipier table
Ø40 H50

Tavolino costituito da blocchi assemblati e torniti di legno massello di tulipier. Spessore base e top 35 mm, diametro colonna 80 mm.
Wooden coffee table made of solid tulipier blocks which are assembled and lathed. Base and top 35 mm thick, column diameter 80 mm.

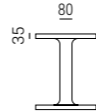

Finiture
Finishes

Tulipier Tulipier						
Code	Cherry stained tulipier OPT1	Wengé stained tulipier OPT2	Walnut stained tulipier OPT3	Natural tulipier OPT4	Black stained tulipier OPT5	Cherry Milano stained tulipier OPT6
Code	Tobacco stained tulipier OPT8	Grey taupe stained tulipier OPT9	Shiny white painted tulipier OPT11	Shiny black painted tulipier OPT12	Charcoal stained tulipier OPT13	Mahogany stained tulipier OPT14

Tavoli
Tables



7TG101
Top in marmo/Marble top
7TG111
Top in metallo/Metal top
7TG121
Top in rovere massello/Solid oak top
Ø50 H50
7TG131
Top in vetro/Glass top
Ø50 H50

7TG102
Top in marmo/Marble top
7TG112
Top in metallo/Metal top
7TG122
Top in rovere massello/Solid oak top
Ø60 H40
7TG132
Top in vetro/Glass top
Ø60 H40

7TG103
Top in marmo/Marble top
7TG113
Top in metallo/Metal top
7TG123
Top in rovere massello/Solid oak top
Ø100 H35
7TG133
Top in vetro/Glass top
Ø100 H35

7TG104
Top in marmo/Marble top
7TG114
Top in metallo/Metal top
7TG124
Top in rovere massello/Solid oak top
L120 P71 H35
7TG134
Top in vetro/Glass top
L120 P71 H35

Top: marmo/rovere massello, spessore 20 mm
Base: tubo di metallo rotondo, sezione 10 mm
Top: marble/solid oak, 20 mm thick
Base: square metal tube, section 10 mm



Top: metallo, spessore 10 mm
Base: tubo di metallo rotondo, sezione 10 mm
Top: metal, 10 mm thick
Base: square metal tube, section 10 mm

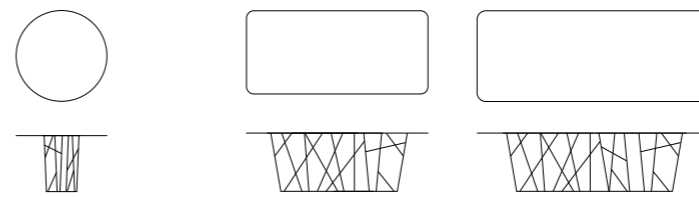
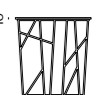

7TG139
Top in marmo/Marble top
7TG140
Top impiallacciato rovere
Oak veneer top
Ø120 H74

7TG134
Top in marmo/Marble top
7TG135
Top impiallacciato rovere
Oak veneer top
7TG138
Top in vetro/Glass top
L240 P110 H74

7TG136
Top in marmo/Marble top
L300 P120 H74
7TG137
Top impiallacciato rovere
Oak veneer top
7TG143
Top in vetro/Glass top
L310 P120 H74



Twig
DESIGN
ELEONORA POZZI
2017

Finiture
Finishes

Top in marmo Marble top								
Code	White Carrara marble OPP1	Black Marquinia marble OPP2	Brown Emperador marble OPP3	Calacatta gold marble OPP7	Black and gold marble OPP9	Perfetto brown marble OPP10		
Code	Grey Stone marble OPP11	Guatemala green marble OPP12	Velvet brown marble OPP13	Amani Bronze marble OPP14	Covelano white marble OPP15			
Top in Gres Porcellanato Porcelain Stoneware Top								
Code	Carrara Pure OPG1	Nero Marquinia OPG2	Statuario Select OPG3	Calacatta Royal OPG4				
Top in legno Wooden top								
Code	Cherry stained oak OPR1	Wengé stained oak OPR2	Walnut stained oak OPR3	Natural oak OPR4	Black stained oak OPR5	Cherry Milano stained oak OPR6		
Code	Tobacco stained oak OPR8	Grey taupe stained oak OPR9	Whitened oak OPR10	Charcoal stained oak OPR11	Mahogany stained oak OPR12	Moka matt stained oak OPR15		
Top in metallo Metal top								
Code	Brushed matt dark grey metal OPM3	Classic bronze painted metal OPM9	Golden beach painted metal OPM10	Gold pearl painted metal OPM11	Brushed copper metal OPM12	Brushed antique brass metal OPM13	Brushed antique gold metal OPM15	Anodyc Bronze metal OPM18
Base in metallo Metal base								
Code	Shiny chrome metal * OPM1	Brushed matt chrome metal OPM2	Brushed matt dark grey metal OPM3	Classic bronze painted metal OPM9	Golden beach painted metal OPM10	Gold pearl painted metal OPM11	Brushed copper metal OPM12	
Code	Brushed antique brass metal OPM13	Shiny black chrome metal * OPM14	Brushed antique gold metal OPM15	Shiny brass chrome metal * OPM16	Bronze metal * OPM17	Anodyc Bronze painted metal OPM18		
Code	Brushed antique brass metal OPM13	Shiny black chrome metal * OPM14	Brushed antique gold metal OPM15	Shiny brass chrome metal * OPM16	Bronze metal * OPM17	Anodyc Bronze painted metal OPM18		

* non disponibile per i tavoli 7TG136, 7TG137 e 7TG143
* not available for 7TG136, 7TG137 and 7TG143 tables

Well
DESIGN
GIULIANO CAPPELLETTI
1999

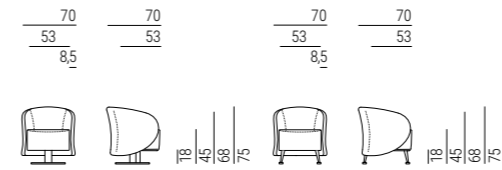

Struttura: tubolare d'acciaio rivestito con schiuma di poliuretano a freddo ignifugo classe 11M
Molleggio di seduta: cinghie elastiche intrecciate.
Rivestimento: non sfoderabile.

Romp: buisstaal bekleed met brandvertragend koudschuim klasse 11M.
Zitvering: door elkaar geweven elastische singels.
Bekleding: vast.

Frame: drawn tubular steel structure upholstered with cold flexible polyurethane foam classified as a class 11M fire-proof material.
Seat springs: intertwined elastic belts.
Cover: not removable.

Несущая конструкция: стальные трубки, покрытые огнеупорным пенополиуретаном, нанесенным холодным способом, класса 11M
Пружинение сиденья: плетеные эластичные ремни.
Покрывтие: не снимается.

Gestell aus gezogenem Stahlrohr, Polsterung aus kaltgeschäumtem, weichem PUR-Schaum, Feuerwiderstands Klasse 11M.
Sitzfederung: geflochtene elastische Gurte.
Bezug: nicht abziehbar.

Poltrone
Armchairs



9WE101
Poltrona
Armchair
L70 P70 H75



9WX101
Poltrona girevole
Swivel armchair
L70 P70 H75



9WX102
Poltrona girevole
Swivel armchair
L70 P70 H80

Finiture
Finishes

Piedini in metallo Metal feet (9WE101) Base girevole Swivel base (9WX102)								
Code	Shiny chrome metal OPM1	Brushed matt chrome metal OPM2	Brushed matt dark grey metal OPM3	RAL 9017 black painted metal OPM6	Classic bronze painted metal OPM9	Golden beach painted metal OPM10	Gold pearl painted metal OPM11	Brushed copper metal OPM12
Code	Brushed antique brass metal OPM13	Shiny black chrome metal OPM14	Brushed antique gold metal OPM15	Shiny brass chrome metal OPM16	Bronze metal OPM17	Anodyc Bronze painted metal OPM18		
Base girevole Swivel base (9WX101)								
Code	Shiny chrome metal OPM1	Brushed matt chrome metal OPM2						

William

DESIGN
STUDIO MARELLI
2020

Fusto in legno massello e legno multistrato con cinghie elastiche intrecciate. Imbottitura in poliuretano espanso rivestito in vellutino bianco. Cuscini di schienale in Piumafib, una speciale miscela ipoallergenica di vera piuma e fibra poliestere siliconata*.

Cuscini di seduta costituiti da un inserto in poliuretano con densità di 30 Kg/m³ ricoperto da un trapuntino di vera piuma imbottito a scomparti*.

Completamente sfoderabile in tessuto, non sfoderabile in pelle e finta pelle.

Kit letto non disponibile.

*Manutenzione dei cuscini contenenti piuma:

I cuscini contenenti piuma tendono a deformarsi con l'utilizzo.

Per mantenerne la forma è necessario, anche dopo un breve utilizzo, battere e sprimacciare ripetutamente i cuscini. Non utilizzare mai battipanni o aspirapolvere.

A coloro che non desiderassero seguire queste indicazioni o che volessero un divano dall'aspetto meno vissuto, raccomandiamo di preferire dei cuscini in gomma.

Car casse en bois massif et multiplis muni de bandes élastiques entrecroisées et finie de mousse polyuréthane couverte de dacron. Coussins de dossier en Piumafib, un mélange hypoallergénique spécial de véritable duvet et fibre polyester siliconisée.*

Les coussins d'assise sont composés d'un noyau en mousse polyuréthane d'une densité de 30 kg/m³ couvert de véritable duvet broché en compartiments.*

Revêtement complètement déhoussable en tissu, fixe en cuir et cuir look.

Pas disponible en canapé-lit.

**Entretien de coussins en duvet:*

Coussins en duvet ont tendance à perdre leur forme dû à l'usage.

Pour en conserver la forme il est nécessaire, aussi après un usage court, de régulièrement battre les coussins. Ne jamais utiliser la tapette ou l'aspirateur.

A ceux qui ne désirent pas suivre ces indications ou qui souhaitent un canapé qui ait l'air moins "usé", nous conseillons vivement de choisir des coussins en mousse polyuréthane.

Frame made of solid wood and multi-ply wood with interwoven elastic straps. The upholstery is made of polyurethane foam, covered with dacron. The back cushions are filled with Piumafib, a special hypoallergenic mixture of feathers and siliconised polyfibre.*

The seat cushions are made of a foam insert with density of 30 Kg/m³, covered with a feather compartments quilt.*

Fully removable fabric covers, fixed leather and artificial leather covers.

Sofa-bed is not available.

**Maintenance of feather cushions:*

Cushions filled with feathers tend to change their shape with use.

In order to keep their shape it is necessary, even after a short use, to plump up the cushions repeatedly. Never use carpet beater or vacuum cleaner.

We recommend to choose foam cushions to those who do not wish to follow these instructions or to have a "used look" sofa.

Для производства каркаса используется массив дерева и многослойная фанера в сочетании с перекрещивающимися эластичными ремнями. Наполнение из полиуретана, обернутого в белый бархат. Наполнение подушек спинки выполнено из материала Piumafib – специальной, не вызывающей аллергию смеси из натурального пуха и полиэфирных силиконовых волокон. Подушки сиденья: стеганые по отсекам, наполнение из натурального пуха с вставками из полиуретана плотностью 30 кг/м³ *.*

Полностью съемные чехлы из ткани, несъемные чехлы из кожи.

диван-кровать не предоставляется.

**Эксплуатация подушек с пуховым наполнением:*

В процессе эксплуатации подушки с пуховым наполнением могут деформироваться, во избежание чего их необходимо слегка взбивать вручную даже после непродолжительного нахождения на диване. Использование в этих целях пылесоса или выбивалки для одежды категорически запрещено. Если клиент не планирует следовать данным инструкциям и хочет, чтобы подушки сиденья и спинки проминались по минимуму, посоветуйте выбрать наполнение только из полиуретана, полностью исключив натуральный пух.

Das Gestell besteht aus Massiv- und Schichtholz, mit geflochtenen Gummigurten, gepolstert mit Polyurethanschaumstoff, mit Dacron bezogen.

Rueckenkissen aus Piumafib, einer hypoallergenischen speziellen Mischung aus echter Daune und silikonisierter Polyesterfaser.*

Die Sitzkissen bestehen aus einem Schaumkern mit Dichte 30 Kg/m³ mit einer gekammerten Daunenaufgabe.*

Stoffbezüge alle abziehbar, Leder und Kunstleder festbezogen.

Als Bettsofa nicht verfügbbar.

**Wartungsanleitungen fuer Daunenkissen:*

Die Kissen, die Daunen enthalten, neigen dazu, sich durch Gebrauch zu verformen.

Um die ursprungliche Form zu halten, ist es notwendig, auch nach kurzem Gebrauch, die Kissen wiederholt aufzuschuettern.

Keinen Ausklopfper oder Staubsauger verwenden.

Unseren Kunden, die diese Anweisungen nicht befolgen moechten, oder die kein Sofa mit solchem "gebrauchten" Aussehen haben moechten, empfehlen wir Polyurethan-Kissen.

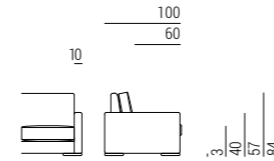
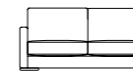
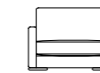
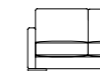
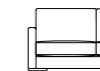
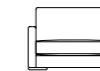
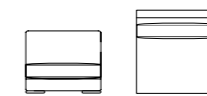
Divani
Sofas**9WIL201**
L160 P100 H84**9WIL202**
L180 P100 H84**9WIL203**
L200 P100 H84**9WIL204**
L220 P100 H84**9WIL205**
L320 P100 H84Elementi componibili
Modular elements**9WIL206**
L110 P100 H84**9WIL207**
L150 P100 H84**9WIL208**
L170 P100 H84**9WIL209**
L190 P100 H84**9WIL210**
L210 P100 H84**9WIL211**
L100 P100 H84**9WIL212**
L110 P110 H84**9WIL213**
L210 P100 H84

William

DESIGN
STUDIO MARELLI
2020

William

DESIGN
STUDIO MARELLI
2020

Dormeuse
Longchair

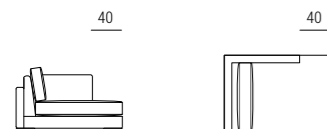

9WIL102
L140 P100 H84

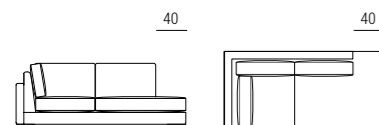

9WIL103
L225 P100 H84

Pouf e accessori
Ottomans and accessories



9WIL104
L100 P100 H84

Cuscinetto in piuma
senza fascia
*Feather cushion
without band*



9CU106
L45 H45

Cuscinetto in piuma
senza fascia
*Feather cushion
without band*



9CU103
L40 H40

Piedini
Feet

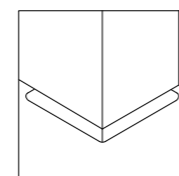

Versione A (standard)
in metallo
Version A (standard)
in metal

H 3 cm

Finiture
Finishes

Piedini in metallo
Versione A
*Metal feet
version A*



Shiny
chrome metal
OPM1

RAL 9017
traffic black
painted metal
OPM6

Classic bronze
painted metal
OPM9

Gold pearl
painted metal
OPM11

Anodized
Bronze metal
OPM18

Code

Divani letto

SOFA BEDS

marelli

Dream

DESIGN
STUDIO MARELLI
2011

Le speciali caratteristiche di questo meccanismo letto brevettato consentono l'apertura e la chiusura del divano con un unico e semplice movimento, senza la necessità di rimuovere i cuscini della seduta e dello schienale che rimangono ancorati alla struttura del meccanismo. Struttura portante del meccanismo in tubo in metallo ad alta resistenza verniciato a polvere epossidica. I braccioli, lo schienale e la fascia anteriore sono fissati con innesti a baionetta per poterli facilmente smontare in fase di trasporto. Rete ortopedica a maglia elettrosaldata. Materasso a molle, alto 14 cm e lungo 200 cm (tolleranza circa 1%). La struttura dei braccioli, dello schienale e della fascia anteriore sono in legno massello e legno multistrato. L'imbottitura è in poliuretano espanso rivestito in vellutino bianco. I cuscini di seduta e di schienale sono in poliuretano espanso con densità di 30kg/m³ rivestito in fibre termolegate e in tessuto di puro cotone. Su richiesta con spazio per riporre i cuscini dietro lo schienale. Completamente sfoderabile in tessuto, non sfoderabile in pelle e in finta pelle.

Les caractéristiques spéciales de ce mécanisme-lit breveté permettent l'ouverture et la fermeture du canapé avec un seul mouvement facile, sans enlever les coussins d'assise qui restent fixés à la structure du mécanisme. Structure du mécanisme en tube métallique à haute résistance, laqué aux poudres époxydiques. Accoudoirs, dossier et bande antérieure fixés à l'aide de baïonnettes pour un facile démontage au moment du transport. Sommier en métal soudé. Matelas à ressorts de cm 200 x 14h. (marge de tolérance environ 1%). Structure des accoudoirs, du dossier et de la bande antérieure constituée de bois massif et de bois multiplis. Rembourrage en mousse polyuréthane revêtue de dacron. Coussins d'assise et de dossier en mousse polyuréthane avec densité de 30 kg/m³, recouverte de dacron et d'un tissu de pur coton. Espace de rangement pour oreillers disponible sur demande. Revêtements en tissu complètement déhoussables, revêtements en cuir et cuir look non déhoussables.

The special features of this patented bed mechanism allow the opening and the closing of the sofa with only one movement, without removing the seat and back cushions, which remain attached to the frame of the mechanism. Mechanism frame in highly resistant metal tube painted with epoxy powder. Armrests, backrest and front band fixed with bayonet joints for an easy disassembly during transport. Welded orthopedic mesh bed base. Spring mattress cm 200 x 14h. (tolerance approx. 1%). Armrests, backrest and front band frame made of solid wood and multiply wood, upholstered with polyurethane foam and covered with dacron. Seat and back cushions made of polyurethane foam with density of 30 kg/m³, covered with dacron and pure cotton fabric. Space to contain pillows behind the backrest available on request. Completely removable fabric covers, fixed leather and artificial leather covers.

Особые характеристики запатентованного механизма, используемого в данной модели, позволяют разложить и сложить диван с помощью одного движения, не снимая перед этим подушек спинки и сиденья, поскольку они составляют единое целое со структурой механизма. Несущая структура механизма изготовлена из металлической трубы повышенной прочности, покрытой эпоксидной порошковой краской. Подлокотники, спинка и передняя часть крепятся при помощи байонетных муфт, что обеспечивает их легкий демонтаж при транспортировке.

Der patentierte Bettmechanismus aus pulverbeschichtetem Stahlrohr ermöglicht durch einfache Rotation des Ruckenteils das schnelle Verwandeln vom Sofa zum komfortablen Bett mit einer 200 cm langen und 14 cm hohen Bonell-Federkernmatratze. (Toleranz zirka 1%). Sitz- und Ruckenkissen muessen nicht entfernt werden. Die Unterfederung besteht aus einem orthopaedischen elektogeschweissten Stahlgitter. Armlehnen, Ruckenteil und Blenden sind aus abgepolstertem Massiv- und Schichtholz und werden mit Keilbeschlaegen an dem Gestell befestigt. Die Sitz- und Ruckenkissen bestehen aus Polyurethenschaumstoff 30 Kg/m³ mit Dacron ummantelt. Stoffbezeuge alle abziehbar, Leder und Kunstleder festbezogen. Optional mit Stauraum fuer Kissen in der Ruckenklehne.

Тип решетки: ортопедическая электросварная Тип матраса: пружинный, высота 14см, длина 200см (допуск +/- 1%) Структура подлокотников, спинки и передней части выполнена из массива древесины в сочетании многослойной фанеры. Наполнение из полиуретана, обернутого в белый бархат. Наполнение подушек сиденья и спинки: пенополиуретан плотностью 30 кг/м³, покрытый термосвязанным волокном и обернутый в ткань из натурального хлопка. По запросу возможно изготовление дивана со специальной нишей для размещения подушек, она располагается позади спинки Полностью съемные чехлы из ткани, несъемные чехлы из кожи (искусственной или натуральной)



Dream

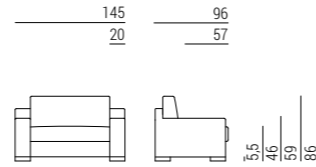

DESIGN
STUDIO MARELLI
2011



Dream

DESIGN
STUDIO MARELLI
2011

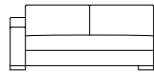

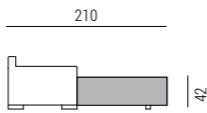
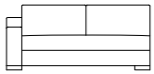
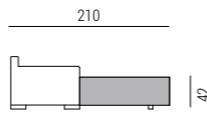
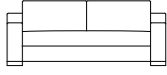
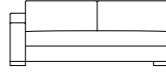
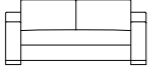
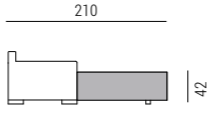
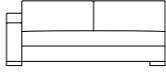
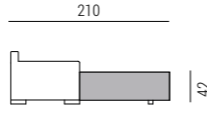
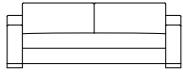
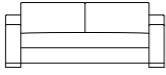
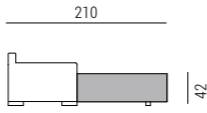
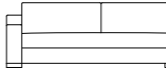
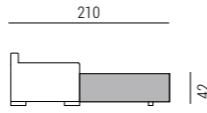
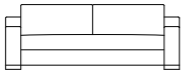
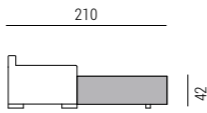
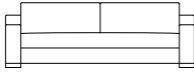
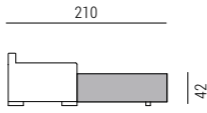
Divani Sofas | Elementi componibili Modular elements | Divani letto Sofa-beds

 9DE105 L145 P96 H86	 9DE204 L190 P96 H87	 9DE102 L145 P96 H86	 Materasso Mattress L75 P200 H14	 9DE202 L190 P96 H87	 Materasso Mattress L140 P200 H14
 9DE203 L210 P96 H87	 9DE304 L210 P96 H87	 9DE101 L186 P96 H87	 Materasso Mattress L116 P200 H14	 9DE302 L210 P96 H87	 Materasso Mattress L160 P200 H14
 9DE303 L230 P96 H87	 9DE201 L210 P96 H87	 Materasso Mattress L140 P200 H14	 9DE402 L230 P96 H87	 Materasso Mattress L180 P200 H14	
	 9DE301 L230 P96 H87	 Materasso Mattress L160 P200 H14			
	 9DE401 L250 P96 H87	 Materasso Mattress L180 P200 H14			

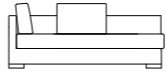
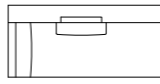
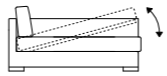
Dormeuse Longchair

 9DE103 L205 P105 H87	
 9DE104 L175 P105 H87	Dormeuse con contenitore Longchair with storage base

Accessori Accessories





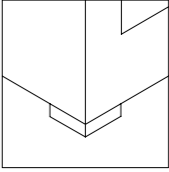
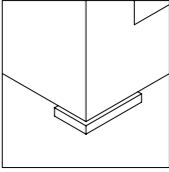







 9VR102 L45 H45	Cuscinetto in piuma con fascia Feather cushion with band
 9CU103 L40 H40	Cuscino in piuma senza fascia Feather cushion without band
 9DE101 L50 H50	Cuscino in piuma con bordo cucitura "a pizzicata" Feather cushion with special "pizzicata" stitching

Piedini Feet

	Versione A (standard) in legno Version A (standard) in wood
	H 5,5 cm
	Versione B in metallo Version B in metal
	H 5,5 cm



Finiture Finishes

Piedini in legno Versione A Wooden feet version A										
	Cherry stained beech OPF1	Wengé stained beech OPF2	Walnut stained beech OPF3	Natural beech OPF4	Black stained beech OPF5	Cherry Milano stained beech OPF6	Tobacco stained beech OPF8	Grey taupe stained beech OPF9	Charcoal stained beech OPF11	Mahogany stained beech OPF12
Piedini in metallo Versione B Metal feet version B										
	Shiny chrome metal OPM1	Brushed matt chrome metal OPM2	Classic bronze painted metal OPM9							



Le speciali caratteristiche di questo meccanismo letto brevettato consentono l'apertura e la chiusura del divano con un unico e semplice movimento, senza la necessità di rimuovere i cuscini della seduta e dello schienale che rimangono ancorati alla struttura del meccanismo. Struttura portante del meccanismo in tubo in metallo ad alta resistenza verniciato a polvere epossidica. I braccioli, lo schienale e la fascia anteriore sono fissati con innesti a baionetta per poterli facilmente smontare in fase di trasporto. Rete ortopedica a maglia elettrosaldata. Materasso a molle, alto 14 cm e lungo 200 cm (tolleranza circa 1%). La struttura dei braccioli, dello schienale e della fascia anteriore sono in legno massello e legno multistrato. L'imbottitura è in poliuretano espanso rivestito in vellutino bianco. I cuscini di seduta e di schienale sono in poliuretano espanso con densità di 30kg/m³ rivestito in fibre termolegate e in tessuto di puro cotone. Su richiesta con spazio per riporre i cuscini dietro lo schienale. Completamente sfoderabile in tessuto, non sfoderabile in pelle e in finta pelle.

Les caractéristiques spéciales de ce mécanisme-lit breveté permettent l'ouverture et la fermeture du canapé avec un seul mouvement facile, sans enlever les coussins d'assise qui restent fixés à la structure du mécanisme. Structure du mécanisme en tube métallique à haute résistance, laqué aux poudres époxydiques. Accoudoirs, dossier et bande antérieure fixés à l'aide de baïonnettes pour un facile démontage au moment du transport. Sommier en métal soudé. Matelas à ressorts de cm 200 x 14h. (marge de tolérance environ 1%). Structure des accoudoirs, du dossier et de la bande antérieure constituée de bois massif et de bois multiplis. Rembourrage en mousse polyuréthane revêtue de dacron. Coussins d'assise et de dossier en mousse polyuréthane avec densité de 30 kg/m³, recouverte de dacron et d'un tissu de pur coton. Espace de rangement pour oreillers disponible sur demande. Revêtements en tissu complètement déhoussables, revêtements en cuir et cuir look non déhoussables.

The special features of this patented bed mechanism allow the opening and the closing of the sofa with only one movement, without removing the seat and back cushions, which remain attached to the frame of the mechanism. Mechanism frame in highly resistant metal tube painted with epoxy powder. Armrests, backrest and front band fixed with bayonet joints for an easy disassembly during transport. Welded orthopedic mesh bed base. Spring mattress cm 200 x 14h. (tolerance approx. 1%). Armrests, backrest and front band frame made of solid wood and multiply wood, upholstered with polyurethane foam and covered with dacron. Seat and back cushions made of polyurethane foam with density of 30 kg/m³, covered with dacron and pure cotton fabric. Space to contain pillows behind the backrest available on request. Completely removable fabric covers, fixed leather and artificial leather covers.

Особые характеристики запатентованного механизма, используемого в данной модели, позволяют разложить и сложить диван с помощью одного движения, не снимая перед этим подушек спинки и сиденья, поскольку они составляют единое целое со структурой механизма. Несущая структура механизма изготовлена из металлической трубы повышенной прочности, покрытой эпоксидной порошковой краской. Подлокотники, спинка и передняя часть крепятся при помощи байонетных муфт, что обеспечивает их легкий демонтаж при транспортировке.

Der patentierte Bettmechanismus aus pulverbeschichtetem Stahlrohr ermöglicht durch einfache Rotation des Ruckenteils das schnelle Verwandeln vom Sofa zum komfortablen Bett mit einer 200 cm langen und 14 cm hohen Bonell-Federkernmatratze. (Toleranz zirka 1%). Sitz- und Ruckenkissen muessen nicht entfernt werden. Die Unterfederung besteht aus einem orthopaedischen elektogeschweissten Stahlgitter. Armlehnen, Ruckenteil und Blenden sind aus abgepolstertem Massiv- und Schichtholz und werden mit Keilbeschlaegen an dem Gestell befestigt. Die Sitz- und Ruckenkissen bestehen aus Polyurethenschaumstoff 30 Kg/m³ mit Dacron ummantelt. Stoffbezeuge alle abziehbar, Leder und Kunstleder festbezogen. Optional mit Stauraum fuer Kissen in der Ruckenklehne.

Тип решетки: ортопедическая электросварная Тип матраса: пружинный, высота 14см, длина 200см (допуск +/- 1%) Структура подлокотников, спинки и передней части выполнена из массива древесины в сочетании многослойной фанерой. Наполнение из полиуретана, обернутого в белый бархат. Наполнение подушек сиденья и спинки: пенополиуретан плотностью 30 кг/м³, покрытый термосвязанным волокном и обернутый в ткань из натурального хлопка. По запросу возможно изготовление дивана со специальной нишей для размещения подушек, она располагается позади спинки Полностью съёмные чехлы из ткани, несъёмные чехлы из кожи (искусственной или натуральной)



Guest



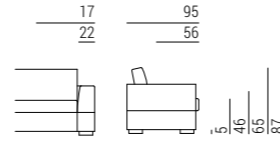

DESIGN
STUDIO MARELLI
1999

Guest

DESIGN
STUDIO MARELLI
1999

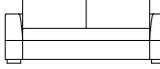
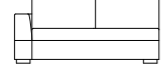

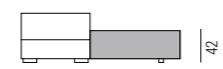
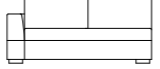
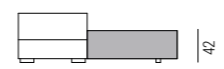
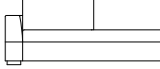
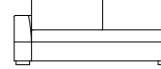
Divani Sofas | Elementi componibili Modular elements | Divani letto Sofa-beds

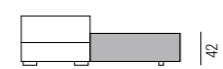
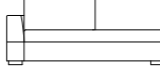
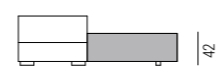
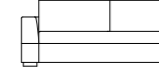
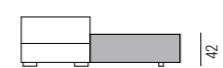
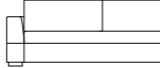
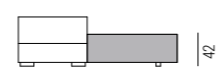
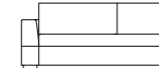
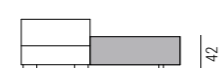
 9GU203 L214 P95 H87	 9GU204 L194 P95 H87	 9GU101 L190 P95 H87	 Materasso Mattress L116 P200 H14	 9GU202 L194 P95 H87	 Materasso Mattress L140 P200 H14
 9GU303 L234 P95 H87	 9GU304 L214 P95 H87	 9GU201 L214 P95 H87	 Materasso Mattress L140 P200 H14	 9GU302 L214 P95 H87	 Materasso Mattress L160 P200 H14
		 9GU301 L234 P95 H87	 Materasso Mattress L160 P200 H14	 9GU402 L234 P95 H87	 Materasso Mattress L180 P200 H14
		 9GU401 L254 P95 H87	 Materasso Mattress L180 P200 H14		

Dormeuse Longchair

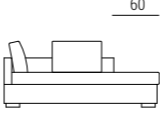

9GU103
L205 P95 H87

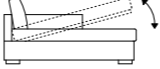

9GU104
L175 P95 H87

Dormeuse con contenitore Longchair with storage base

Accessori Accessories



9VR102
L45 H45

Cuscinetto in piuma con fascia Feather cushion with band



9CU103
L40 H40

Cuscinetto in piuma senza fascia Feather cushion without band

Piedini Feet

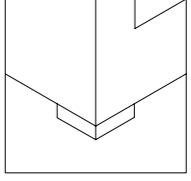

Versione A (standard)
in legno
Version A (standard)
in wood

H 5,5 cm

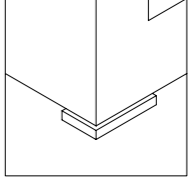











Versione B
in metallo
Version B
in metal

H 5,5 cm

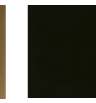



Finiture Finishes

Piedini in legno Versione A Wooden feet version A

									
Cherry stained beech OPF1	Wengé stained beech OPF2	Walnut stained beech OPF3	Natural beech OPF4	Black stained beech OPF5	Cherry Milano stained beech OPF6	Tobacco stained beech OPF8	Grey taupe stained beech OPF9	Charcoal stained beech OPF11	Mahogany stained beech OPF12

Piedini in metallo Versione B Metal feet version B

		
Shiny chrome metal OPM1	Brushed matt chrome metal OPM2	Classic bronze painted metal OPM9

Le speciali caratteristiche di questo meccanismo letto brevettato consentono l'apertura e la chiusura del divano con un unico e semplice movimento, senza la necessità di rimuovere i cuscini della seduta e dello schienale che rimangono ancorati alla struttura del meccanismo. Struttura portante del meccanismo in tubo in metallo ad alta resistenza verniciato a polvere epossidica. I braccioli, lo schienale e la fascia anteriore sono fissati con innesti a baionetta per poterli facilmente smontare in fase di trasporto. Rete ortopedica a maglia elettrosaldata. Materasso a molle, alto 14 cm e lungo 200 cm (tolleranza circa 1%). La struttura dei braccioli, dello schienale e della fascia anteriore sono in legno massello e legno multistrato. L'imbottitura è in poliuretano espanso rivestito in vellutino bianco. I cuscini di seduta e di schienale sono in poliuretano espanso con densità di 30kg/m³ rivestito in fibre termolegate e in tessuto di puro cotone. Su richiesta con spazio per riporre i cuscini dietro lo schienale. Completamente sfoderabile in tessuto, non sfoderabile in pelle e in finta pelle.

Les caractéristiques spéciales de ce mécanisme-lit breveté permettent l'ouverture et la fermeture du canapé avec un seul mouvement facile, sans enlever les coussins d'assise qui restent fixés à la structure du mécanisme. Structure du mécanisme en tube métallique à haute résistance, laqué aux poudres époxydiques. Accoudoirs, dossier et bande antérieure fixés à l'aide de baïonnettes pour un facile démontage au moment du transport. Sommier en métal soudé. Matelas à ressorts de cm 200 x 14h. (marge de tolérance environ 1%). Structure des accoudoirs, du dossier et de la bande antérieure constituée de bois massif et de bois multiplis. Rembourrage en mousse polyuréthane revêtue de dacron. Coussins d'assise et de dossier en mousse polyuréthane avec densité de 30 kg/m³, recouverte de dacron et d'un tissu de pur coton. Espace de rangement pour oreillers disponible sur demande. Revêtements en tissu complètement déhoussables, revêtements en cuir et cuir look non déhoussables.

The special features of this patented bed mechanism allow the opening and the closing of the sofa with only one movement, without removing the seat and back cushions, which remain attached to the frame of the mechanism. Mechanism frame in highly resistant metal tube painted with epoxy powder. Armrests, backrest and front band fixed with bayonet joints for an easy disassembly during transport. Welded orthopedic mesh bed base. Spring mattress cm 200 x 14h. (tolerance approx. 1%). Armrests, backrest and front band frame made of solid wood and multiply wood, upholstered with polyurethane foam and covered with dacron. Seat and back cushions made of polyurethane foam with density of 30 kg/m³, covered with dacron and pure cotton fabric. Space to contain pillows behind the backrest available on request. Completely removable fabric covers, fixed leather and artificial leather covers.

Особые характеристики запатентованного механизма, используемого в данной модели, позволяют разложить и сложить диван с помощью одного движения, не снимая перед этим подушек спинки и сиденья, поскольку они составляют единое целое со структурой механизма. Несущая структура механизма изготовлена из металлической трубы повышенной прочности, покрытой эпоксидной порошковой краской. Подлокотники, спинка и передняя часть крепятся при помощи байонетных муфт, что обеспечивает их легкий демонтаж при транспортировке.

Der patentierte Bettmechanismus aus pulverbeschichtetem Stahlrohr ermöglicht durch einfache Rotation des Ruckenteils das schnelle Verwandeln vom Sofa zum komfortablen Bett mit einer 200 cm langen und 14 cm hohen Bonell-Federkernmatratze. (Toleranz zirka 1%). Sitz- und Ruckenkissen muessen nicht entfernt werden. Die Unterfederung besteht aus einem orthopaedischen elektogeschweissten Stahlgitter. Armlehnen, Ruckenteil und Blenden sind aus abgepolsterem Massiv- und Schichtholz und werden mit Keilbeschlaegen an dem Gestell befestigt. Die Sitz- und Ruckenkissen bestehen aus Polyurethenschaumstoff 30 Kg/m³ mit Dacron ummantelt. Stoffbezeuge alle abziehbar, Leder und Kunstleder festbezogen. Optional mit Stauraum fuer Kissen in der Ruckenlehne.

*Тип решетки: ортопедическая электросварная
Тип матраса: пружинный, высота 14см, длина 200см (допуск +/- 1%) Структура подлокотников, спинки и передней части выполнена из массива древесины в сочетании многослойной фанерой. Наполнение из полиуретана, обернутого в белый бархат. Наполнение подушек сиденья и спинки: пенополиуретан плотностью 30 кг/м³, покрытый термосвязанным волокном и обернутый в ткань из натурального хлопка. По запросу возможно изготовление дивана со специальной нишей для размещения подушек, она располагается позади спинки Полностью съемные чехлы из ткани, несъемные чехлы из кожи (искусственной или натуральной)*

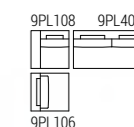

Rem

DESIGN
STUDIO MARELLI
2013

Le speciali caratteristiche di questo meccanismo letto brevettato consentono l'apertura e la chiusura del divano con un unico e semplice movimento, senza la necessità di rimuovere i cuscini della seduta e dello schienale che rimangono ancorati alla struttura del meccanismo. Struttura portante del meccanismo in tubo in metallo ad alta resistenza verniciato a polvere epossidica. I braccioli, lo schienale e la fascia anteriore sono fissati con innesti a baionetta per poterli facilmente smontare in fase di trasporto. Rete ortopedica a maglia elettrosaldata. Materasso a molle, alto 14 cm e lungo 200 cm (tolleranza circa 1%). La struttura dei braccioli, dello schienale e della fascia anteriore sono in legno massello e legno multistrato. L'imbottitura è in poliuretano espanso rivestito in vellutino bianco. I cuscini di seduta e di schienale sono in poliuretano espanso con densità di 30kg/m³ rivestito in fibre termolegate e in tessuto di puro cotone. Su richiesta con spazio per riporre i cuscini dietro lo schienale. Completamente sfoderabile in tessuto, non sfoderabile in pelle e in finta pelle.

Les caractéristiques spéciales de ce mécanisme-lit breveté permettent l'ouverture et la fermeture du canapé avec un seul mouvement facile, sans enlever les coussins d'assise qui restent fixés à la structure du mécanisme. Structure du mécanisme en tube métallique à haute résistance, laqué aux poudres époxydiques. Accoudoirs, dossier et bande antérieure fixés à l'aide de baïonnettes pour un facile démontage au moment du transport. Sommier en métal soudé. Matelas à ressorts de cm 200 x 14h. (marge de tolérance environ 1%). Structure des accoudoirs, du dossier et de la bande antérieure constituée de bois massif et de bois multiplis. Rembourrage en mousse polyuréthane revêtu de dacron. Coussins d'assise et de dossier en mousse polyuréthane avec densité de 30 kg/m³, recouverte de dacron et d'un tissu de pur coton. Espace de rangement pour oreillers disponible sur demande. Revêtements en tissu complètement déhoussables, revêtements en cuir et cuir look non déhoussables.

The special features of this patented bed mechanism allow the opening and the closing of the sofa with only one movement, without removing the seat and back cushions, which remain attached to the frame of the mechanism. Mechanism frame in highly resistant metal tube painted with epoxy powder. Armrests, backrest and front band fixed with bayonet joints for an easy disassembly during transport. Welded orthopedic mesh bed base. Spring mattress cm 200 x 14h. (tolerance approx. 1%). Armrests, backrest and front band frame made of solid wood and multiply wood, upholstered with polyurethane foam and covered with dacron. Seat and back cushions made of polyurethane foam with density of 30 kg/m³, covered with dacron and pure cotton fabric. Space to contain pillows behind the backrest available on request. Completely removable fabric covers, fixed leather and artificial leather covers.

Особые характеристики запатентованного механизма, используемого в данной модели, позволяют разложить и сложить диван с помощью одного движения, не снимая перед этим подушек спинки и сиденья, поскольку они составляют единое целое со структурой механизма. Несущая структура механизма изготовлена из металлической трубы повышенной прочности, покрытой эпоксидной порошковой краской. Подлокотники, спинка и передняя часть крепятся при помощи байонетных муфт, что обеспечивает их легкий демонтаж при транспортировке.

Der patentierte Bettmechanismus aus pulverbeschichtetem Stahlrohr ermöglicht durch einfache Rotation des Ruckenteils das schnelle Verwandeln vom Sofa zum komfortablen Bett mit einer 200 cm langen und 14 cm hohen Bonell-Federkernmatratze. (Toleranz zirka 1%). Sitz- und Ruckenkissen muessen nicht entfernt werden. Die Unterfederung besteht aus einem orthopaedischen elektogeschweissten Stahlgitter. Armlehnen, Ruckenteil und Blenden sind aus abgepolstertem Massiv- und Schichtholz und werden mit Keilbeschlaegen an dem Gestell befestigt. Die Sitz- und Ruckenkissen bestehen aus Polyurethenschaumstoff 30 Kg/m³ mit Dacron ummantelt. Stoffbezeuge alle abziehbar, Leder und Kunstleder festbezogen. Optional mit Stauraum fuer Kissen in der Ruckenklehne.

Тип решетки: ортопедическая электросварная Тип матраса: пружинный, высота 14см, длина 200см (допуск +/- 1%) Структура подлокотников, спинки и передней части выполнена из массива древесины в сочетании многослойной фанеры. Наполнение из полиуретана, обернутого в белый бархат. Наполнение подушек сиденья и спинки: пенополиуретан плотностью 30 кг/м³, покрытый термосвязанным волокном и обернутый в ткань из натурального хлопка. По запросу возможно изготовление дивана со специальной нишей для размещения подушек, она располагается позади спинки Полностью съемные чехлы из ткани, несъемные чехлы из кожи (искусственной или натуральной)



9DR209 9DR104

Rem



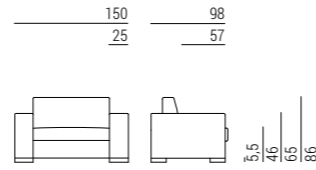

DESIGN
STUDIO MARELLI
2013

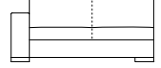
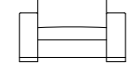
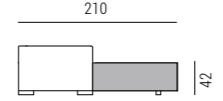
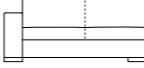
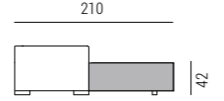
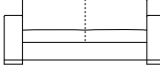
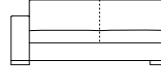
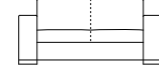
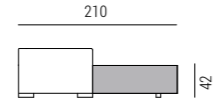
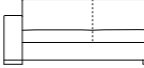
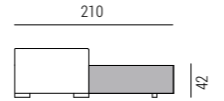
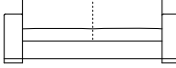
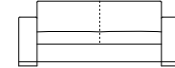

Rem

DESIGN
STUDIO MARELLI
2013

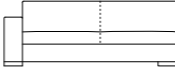
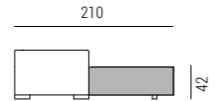
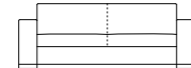

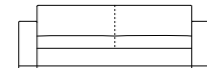
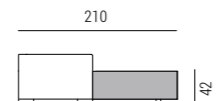
Divani Sofas | Elementi componibili Modular elements | Divani letto Sofa-beds

 9RE101 L150 P98 H86	 9RE203 L190 P98 H86	 9RE102 L150 P98 H86	 Materasso Mattress L75 P200 H14	 9RE208 L190 P98 H86	 Materasso Mattress L140 P200 H14
 9RE201 L215 P98 H86	 9RE204 L210 P98 H86	 9RE205 L190 P98 H86	 Materasso Mattress L116 P200 H14	 9RE209 L210 P98 H86	 Materasso Mattress L160 P200 H14
 9RE202 L235 P98 H86	 9RE206 L215 P98 H86	 Materasso Mattress L140 P200 H14	 9RE302 L230 P98 H86	 Materasso Mattress L180 P200 H14	
	 9RE207 L235 P98 H86	 Materasso Mattress L160 P200 H14			
	 9RE301 L255 P98 H86	 Materasso Mattress L180 P200 H14			

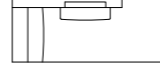
Dormeuse Longchair

 9RE103 L205 P98 H86	 9RE104 L175 P98 H86
	Dormeuse con contenitore Longchair with storage base







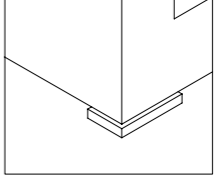
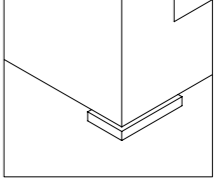





Accessori Accessories

 9VR102 L45 H45	Cuscinetto in piuma con fascia Feather cushion with band
 9CU103 L40 H40	Cuscinetto in piuma senza fascia Feather cushion without band

Piedini Feet

	Versione A (standard) in metallo Version A (standard) in metal	H 5,5 cm
	Versione B in legno Version B in wood	H 5,5 cm

Finiture Finishes

Piedini in metallo Versione A Metal feet version A										
Code	Shiny chrome metal OPM1	Brushed matt chrome metal OPM2	Classic bronze painted metal OPM9							
Piedini in legno Versione B Wooden feet version B										
Code	Cherry stained beech OPF1	Wengé stained beech OPF2	Walnut stained beech OPF3	Natural beech OPF4	Black stained beech OPF5	Cherry Milano stained beech OPF6	Tobacco stained beech OPF8	Grey taupe stained beech OPF9	Charcoal stained beech OPF11	Mahogany stained beech OPF12

graphic
Matteo Paoloni

concept and stylist creator
Morena Colombo

photo
Riccardo Bianchi
IKB Studio

all rights reserved © 2020

marelli

Giulio Marelli Italia SpA

Via Indipendenza 159 20821 Meda (MB) Italia T ++39 0362 342116
info@giuliomarelli.com www.giuliomarelli.com



marelli

Giulio Marelli Italia SpA
Via Indipendenza 159 20821 Meda (MB) Italia T ++39 0362 342116
info@giuliomarelli.com www.giuliomarelli.com