



PREVIEW COLLECTION 2021

**OZZIO**<sup>®</sup> ITALIA

La storia di Ozzio Italia inizia nel 1961 nella culla di molte eccellenze dell'italian design: il distretto della Brianza a nord di Milano. Nel primo laboratorio artigiano della famiglia Pozzoli si coltiva la qualità: con questa filosofia e un forte legame con il proprio territorio, l'azienda cresce fino a diventare oggi un brand internazionale, presente con i suoi prodotti in 5 continenti. La collezione Ozzio Italia è contraddistinta da una particolare interpretazione della vita contemporanea, frutto di una visione in grado di raccogliere ispirazioni da tutto il mondo e trasformarle in proposte dall'inconfondibile stile italiano. Ozzio Italia ha posto le basi del proprio sales network internazionale a partire dagli anni 90. Oggi l'azienda è una realtà di riferimento nell'ambito dell'arredamento multifunzione, con una consolidata presenza in Europa, America, Asia e Russia confermata da showroom istituzionali nelle più importanti città del mondo.

The history of Ozzio Italia started in 1961, in the cradle of many italian design excellences: the Brianza district, located north of Milano. In the first artisan workshop of the Pozzoli Family, quality was the first value: with this philosophy and a strong bond with its homeland, the company grows until becoming, today, an international brand, currently available throughout five continents.

The Ozzio collection is characterised by a particular interpretation of contemporary lifestyle, fruit of a vision that gathers inspiration from the whole world and transforms it in unmistakably italian design propositions.

Ozzio laid its international sales network bases starting from the 90s. Today, the company is a reference reality in multi-functional furniture field, with a consolidated turnout in Europe, America, Asia and Russia, confirmed by the presence in the best showrooms in the most important cities of the world.

**OZZIO**<sup>®</sup> ITALIA

TAVOLI /  
TABLES

4 X 4

4



GEM

24



BIG ROUND

72



CONSOLLE/  
CONSOLE

4 YOU

36



GOLIA

60



TRASFORMABILI/  
TRANSFORMABLE ITEMS

BOX

44



SU E GIU'

62



TAVOLINI ELEVABILI/  
MULTIFUNCTIONAL TABLES

BELLAGIO

24

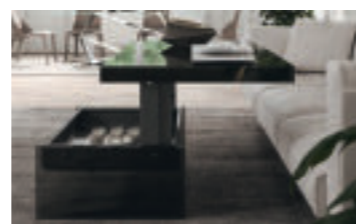

SEDIE/ CHAIRS  
POLTRONCINE/ARMCHAIRS

GIOTTO 4



CUBIX 44  
62

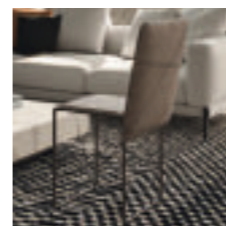

STELLA 42  
SALLY  
SELENA

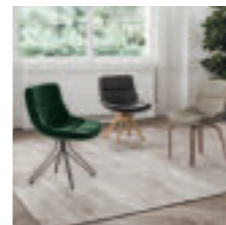

KITE 26



SIRIA 32



RIPIEGO 70



LOREN 72



SGABELLI/  
STOOLS

MORRIS 58



MARLON 58



MORGAN 58



MORFEO 58



MILO 44



COMPLEMENTI/  
COMPLEMENTARY ITEMS

PANTO 4  
24

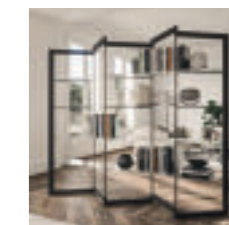

BIJOUX 4



MIAMI VICE 4



GOLDEN BIG 34

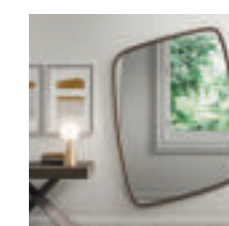

ALIZEE 72



BYBLOS 62  
72

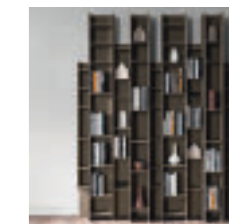

## VILLA LUCERTOLA

Ambiente Open Space affacciato su un rigoglioso paesaggio lacustre armoniosamente suddiviso da due librerie Panto, proposte in due differenti dimensioni. L'iconico tavolo 4x4 è qui rinnovato con il top nella finitura Marble Glass Onice ed attorniato dalle romantiche sedute Giotto rivestite in morbida pelle abbinata ad una solida struttura in legno massello. Completano l'ambiente sala da pranzo gli specchi Miami Vice con cornici abbinata che riprendono il piano del tavolo. Nella zona relax sono protagonisti i tavolini Bijoux con basamento in metallo sagomato e piani di diverso diametro in cristallo o ceramica.

Open Space location overlooking a lake landscape harmoniously divided by two Panto bookcases, proposed in two different sizes.

The iconic 4x4 table is renovated with the top in Marble Glass Onice finish and surrounded by romantic Giotto chairs covered in soft leather combined with a solid wood structure.

Miami Vice mirrors complete the dining room environment with matching frames that reflect the table top.

In the living area the stars are the Bijoux coffee tables with a shaped metal base and tops of different diameters top in glass or and ceramic.



4 X 4

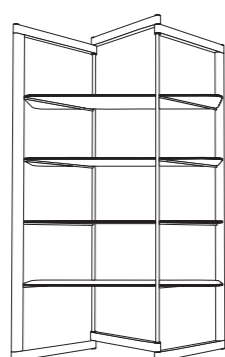

PANTO

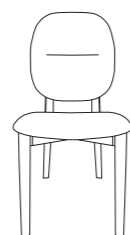

GIOTTO

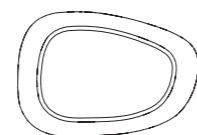

MIAMI VICE



BIJOUX

**Tavolo T240 4X4** piano MG03 base MT97 / **Sedie S010 GIOTTO** seduta P11 base PW94 / **Libreria X016D, X016C PANTO** telaio MT97 cornice PW94 ripiani CR14 - Table T240 4X4 top MG03 structure MT97 / Chairs S010 GIOTTO covering P11 structure PW94 / Bookcase X016D, X016C PANTO frame MT97 structure PW94 shelves CR14 - Tisch T240 4X4 Platte MG03 Struktur MT97 / Stühle S010 GIOTTO Bezug P11 Struktur PW94 / Bücherschrank X016D, X016C PANTO Rahmen MT97 Struktur PW94 Einlegeböden CR14 - Table T240 4X4 plateau MG03 structure MT97 / Chaises S010 GIOTTO revêtement P11 structure PW94 / Bibliothèque X016D, X016C PANTO cadre MT97 structure PW94 étagères CR14 - Mesa T240 4X4 top MG03 estructura MT97 / Sillas S010 GIOTTO tapizado P11 estructura PW94 / Librería X016D, X016C PANTO marco MT97 estructura PW94 estantes CR14 - Стол T240 4X4 верхний MG03 структура MT97 / Стулья S010 GIOTTO покрытие P11 структура PW94 / Каркас книжного шкафа X016D, X016C PANTO рама MT97 конструкция PW94 полки CR14





4X4



Il top di gamma 4x4, nelle immagini in versione con top Marble Glass Onice, coniuga il funzionamento tecnico all'inaspettata continuazione della vena del piano da aperto e da chiuso. L'affascinante meccanismo di apertura brevettato è composto da una perfetta sovrapposizione di incastri solidamente trattenuti tra loro. Basamento in solido metallo formato da quattro gambe incrociate.

Design: Giulio Manzoni  
Prodotto Brevettato

The top seller 4x4, here shown in the version with Marble Glass Onice top, combines technical features with the unexpected continuous marble vein design while open and closed. The fascinating patented opening mechanism is made up of a perfect overlap of joints firmly held together. Strong metal base composed by four crossed legs.

Design: Giulio Manzoni  
Patented Product

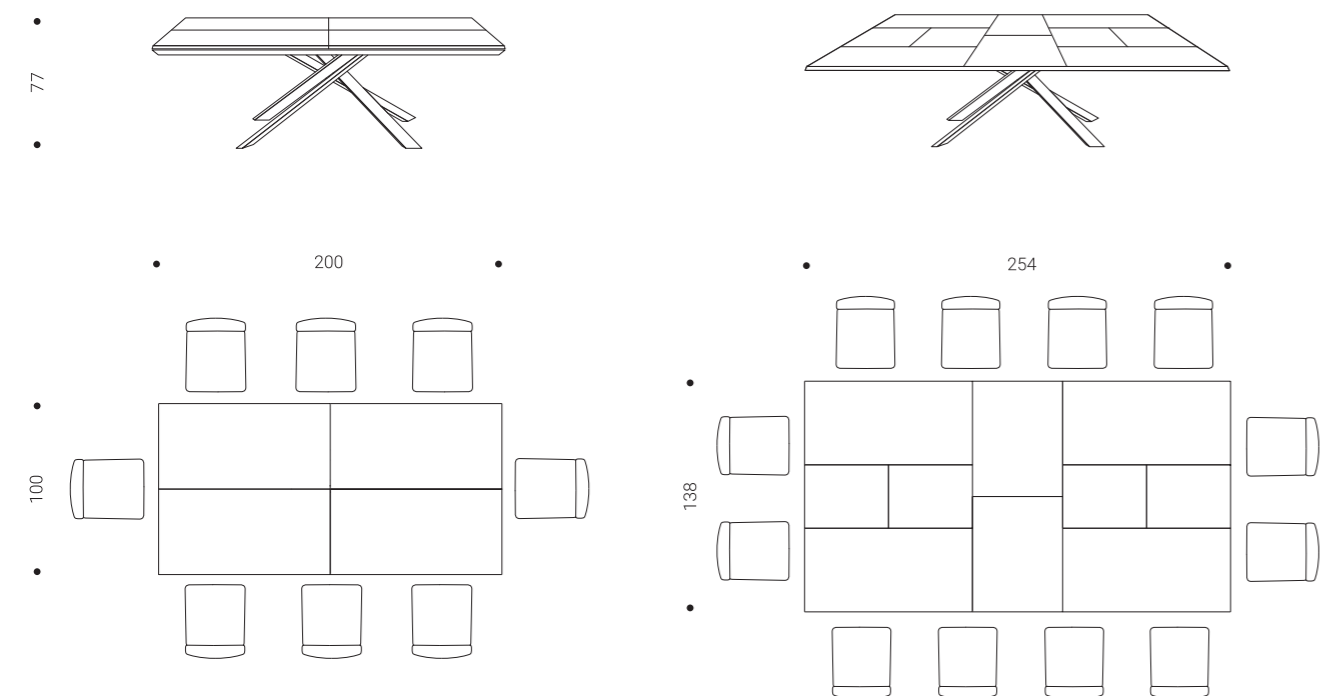

**Tavolo T240 4X4** piano MG03 base MT97 - Table T240 4X4 top MG03 structure MT97 - Tisch T240 4X4 Platte MG03 Struktur MT97  
Table T240 4X4 plateau MG03 structure MT97 - Mesa T240 4X4 top MG03 estructura MT97 - Стол T240 4X4 верхний MG03 структура MT97



**Tavolo T240 4X4** piano MG03 base MT97 / **Sedie S010 GIOTTO** seduta P11 base PW94 / **Specchi X038 MIAMI VICE** cornici MG02, MG03  
Table T240 4X4 top MG03 base MT97 / Chairs S010 GIOTTO covering P11 base PW94 / Mirrors X038 MIAMI VICE frames MG02, MG03  
Tisch T240 4X4 Platte MG03 Gestell MT97 / Stühle S010 GIOTTO Sitz P11 Struktur PW94 / Spiegel X038 MIAMI VICE Gestelle MG02, MG03 - Table T240 4X4 plateau MG03 base MT97 / Chaises S010 GIOTTO revêtement P11 structure PW94 / Miroirs X038 MIAMI VICE

cadres MG02, MG03 - Mesa T240 4X4 top MG03 base MT97 / Sillas S010 GIOTTO asiento P11 Estructura PW94 / Espejos X038 MIAMI VICE marcos MG02, MG03 - Столик T240 4X4 верхний MG03 основание MT97 / Стулья S010 GIOTTO сиденье P11 основание PW94 / Зеркала X038 MIAMI VICE рамы MG02, MG03



# PANTO



La libreria Panto evoca il nome e la funzionalità dello strumento di appartenenza: il Pantografo. Noto utensile che permette di riprodurre forme in scala ridotta o ingrandita, l'esatto concept di questo elemento d'arredo. Panto, attraverso la combinazione di ripiani in cristallo di diversa profondità, è in grado di espandersi e restringersi mutando la sua forma e funzione. Autoportante come separatore di ambienti o posizionata a parete, è perfetta per tutti coloro che desiderano abitualmente riorganizzare spazi attivi.

Design: Andrea Lucatello

Expect the unexpected. Have no doubts The Panto bookcase reminds the name and functionality of the instrument it belongs to: the Pantograph. Known tool allows you to reproduce shapes on a reduced or enlarged scale, the exact concept of this bookcase. Panto, through the combination of glass shelves of different depths, is able to expand and shrink, changing its shape and function. Self-supporting as a room divider or leaning against the wall, it is perfect for all those who usually wish to reorganize active spaces.

Design: Andrea Lucatello

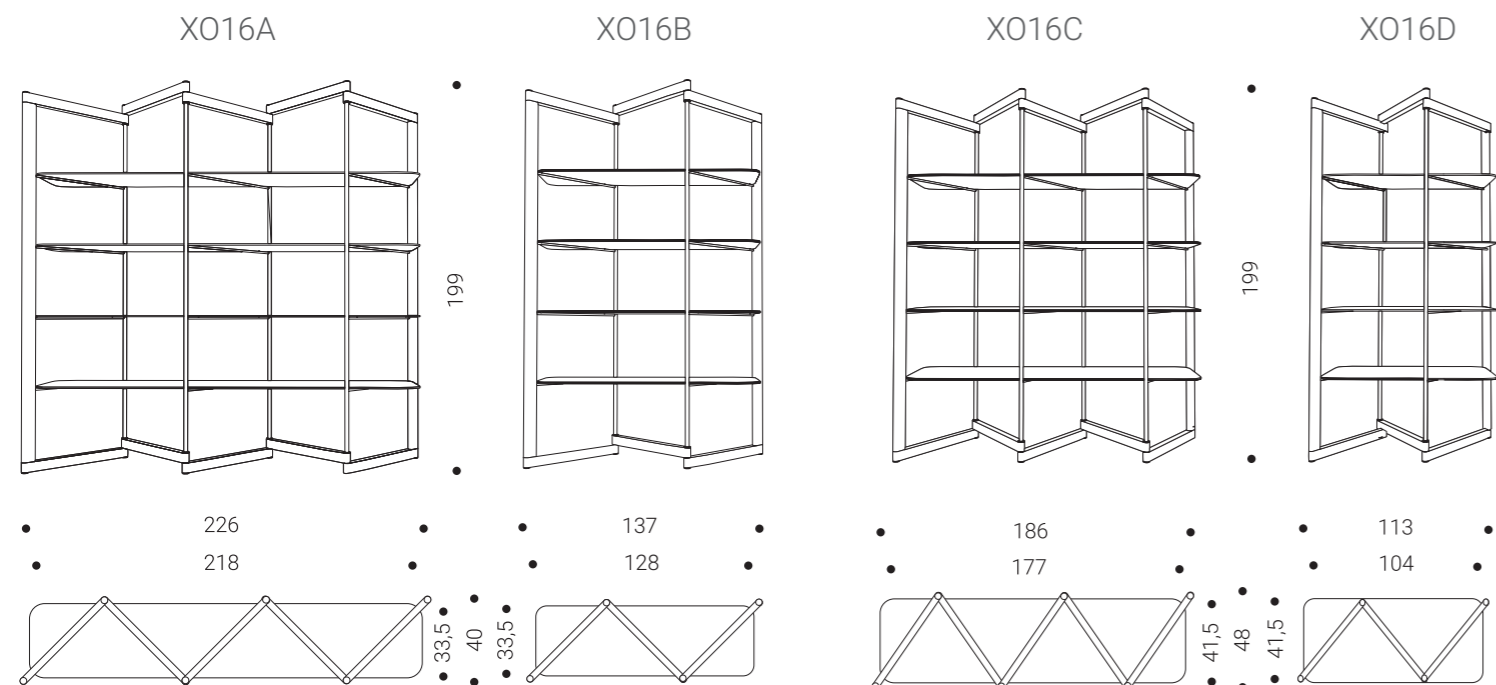

**Libreria X016D, X016C PANTO** telaio MT97 struttura PW94 ripiani CR14 - Bookcase X016D, X016C PANTO frame MT97 structure PW94 shelves CR14 - Bücherschrank X016D, X016C PANTO Rahmen MT97 Struktur PW94 Einlegeböden CR14 - Bibliothèque X016D, X016C PANTO cadre MT97 structure PW94 étagères CR14 - Libreria X016D, X016C PANTO marco MT97 estructura PW94 estantes CR14 - Каркас книжного шкафа X016D, X016C PANTO рама MT97 конструкция PW94 полки CR14





LIBRERIA PANTO PROFONDITA' 40 CM  
PANTO BOOKCASE 40 CM DEPT



VISTA LATERALE  
SIDE VIEW



VISTA FRONTALE LIBRERIA 5 MODULI  
FRONT VIEW BOOKCASE 5 ELEMENTS



VISTA FRONTALE LIBRERIA 3 MODULI  
FRONT VIEW BOOKCASE 3 ELEMENTS



VISTA DALL'ALTO LIBRERIA 5 MODULI  
TOP VIEW BOOKCASE 5 ELEMENTS



VISTA DALL'ALTO LIBRERIA 3 MODULI  
TOP VIEW BOOKCASE 3 ELEMENTS

LIBRERIA PANTO PROFONDITA' 48 CM  
PANTO BOOKCASE 48 CM DEPT



VISTA LATERALE  
SIDE VIEW



VISTA FRONTALE LIBRERIA 5 MODULI  
FRONT VIEW BOOKCASE 5 ELEMENTS



VISTA FRONTALE LIBRERIA 3 MODULI  
FRONT VIEW BOOKCASE 3 ELEMENTS



VISTA DALL'ALTO LIBRERIA 5 MODULI  
TOP VIEW BOOKCASE 5 ELEMENTS



VISTA DALL'ALTO LIBRERIA 3 MODULI  
TOP VIEW BOOKCASE 3 ELEMENTS

# BIJOUX

Discreti e versatili, i tavolini bassi Bijoux composti da tre diverse dimensioni, si combinano in contrasto con le differenti tipologie di piano. Vetro e ceramica con basamento in metallo verniciato impreziosiscono e completano tutti i contesti abitativi.

Design: Massimiliano Mornati

Discreet and versatile, the Bijoux coffee tables made up of three different sizes, match in contrast with the different types of tops. Glass and ceramic with painted metal base enhance and complete all living areas.

Design: Massimiliano Mornati

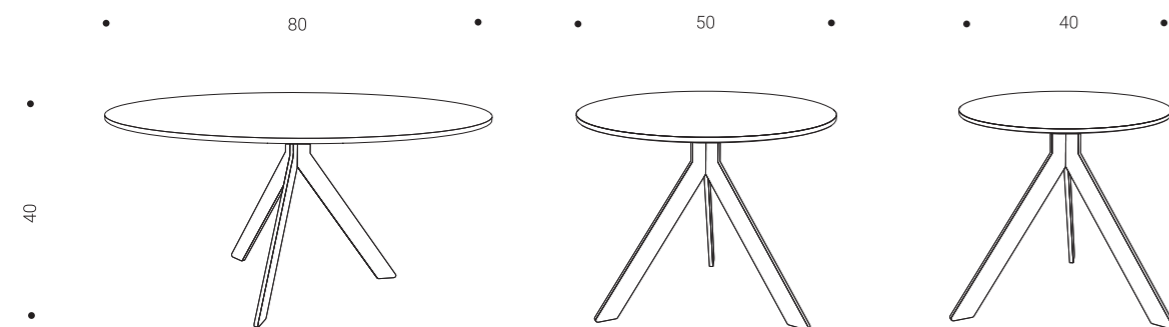

**Tavolini X502 BIJOUX** piani CR12, CC10, CR17 basi MT98, MT16 - Coffee tables X502 BIJOUX tops CR12, CC10, CR17 bases MT98, MT16  
Couchtische X502 BIJOUX Platten CR12, CC10, CR17 Struktur MT98, MT16 - Tables basses X502 BIJOUX plateaux CR12, CC10, CR17  
structure MT98, MT16 - Mesas de centro X502 BIJOUX tops CR12, CC10, CR17 Estructura MT98, MT16 - Кофейные столики X502 BIJOUX  
топы CR12, CC10, CR17 конструкция MT98, MT16



# MIAMI VICE

Specchio dalla forma organica asimmetrica sottolineata da una doppia profondità e da un'elegante bisellatura funzionale. Le cornici in Marble Glass si abbinano armonicamente creando composizioni cromatiche in grado di dare luce e movimento a pareti spoglie.

Design: Studio Ozeta

Mirror with an asymmetrical organic shape highlighted by a double depth and an elegant functional bevel. The Marble Glass frame matches harmoniously and creates chromatic compositions able to give light and movement to bare walls.

Design: Studio Ozeta

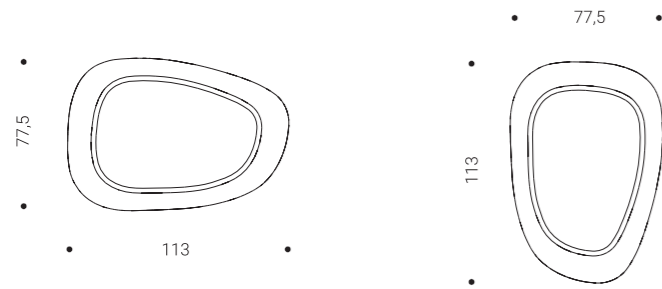

**Specchi X038 MIAMI VICE** cornici MG02, MG03 - **Mirrors X038 MIAMI VICE** frames MG02, MG03 - **Spiegel X038 MIAMI VICE** Gestelle MG02, MG03 - **Miroirs X038 MIAMI VICE** cadres MG02, MG03 - **Espejos X038 MIAMI VICE** marcos MG02, MG03 - **Зеркала X038 MIAMI VICE** рамы MG02, MG03



# GIOTTO

Dall'armonico incontro tra legno e pelle prende forma una seduta che mette a nudo i suoi elementi essenziali. Il rivestimento sapientemente lavorato, evidenzia le cuciture sartoriali e l'impuntura che esalta lo schienale concepito ergonomicamente per fornire il massimo comfort. La struttura in massello plasma giochi di pieni e vuoti mediante configurazioni inflessibili e curvilinee.

Design: Andrea Lucatello

From the harmonious match between wood and leather, a chair takes form and reveals its essential elements. The skillfully handmade cover highlights the tailored stitching that enhances the ergonomically designed backrest to provide the maximum comfort. The solid wood structure shapes design of inflexible and curvilinear configurations.

Design: Andrea Lucatello

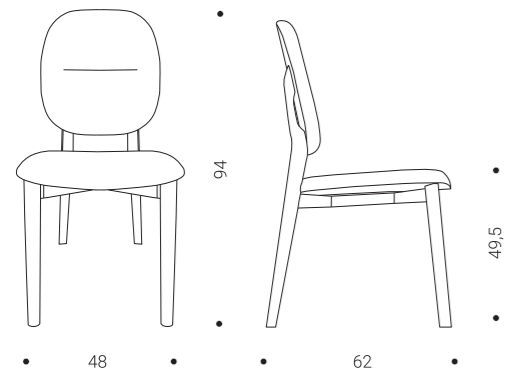

**Sedie S010 GIOTTO** sedute P12, P90, P19 basi PW91, PW95, PW61 - Chairs S010 GIOTTO covering P12, P90, P19 bases PW91, PW95, PW61 - Stühle S010 GIOTTO Sitze P12, P90, P19 Struktur PW91, PW95, PW61 - Chaises S010 GIOTTO revêtement P12, P90, P19 structure PW91, PW95, PW61 - Sillas S010 GIOTTO tapizado P12, P90, P19 Estructura PW91, PW95, PW61 - Стулья S010 GIOTTO сиденья P12, P90, P19 конструкция PW91, PW95, PW61





**Sedie S010 GIOTTO** sedute P12, P90 basi PW91, PW95 - Chairs S010 GIOTTO covering P12, P90 bases PW91, PW95 - Stühle S010 GIOTTO Sitze P12, P90 Struktur PW91, PW95 - Chaises S010 GIOTTO revêtement P12, P90 structure PW91, PW95 - Sillas S010 GIOTTO tapizado P12, P90 Estructura PW91, PW95 - Стулья S010 GIOTTO сиденья P12, P90 конструкция PW91, PW95

## VILLA BELVEDERE

Appartamento signorile e sofisticato, esaltato dal tavolo Gem, novità del piano sagomato con molatura incrociata a doppia bisellatura, vero protagonista della zona pranzo attorniato dalle sedute in cuoio Kite. L'area conviviale esprime tranquillità e sofisticatezza con le librerie Panto collocate a parete, e il tavolino elevabile Bellagio proposto in Marble Glass. L'ingresso apre sulla performante consolle allungabile 4You e l'imponente specchio Golden Big.

Elegant and sophisticated apartment, enhanced by the Gem table, innovation of the shaped top with crossed double bevel grinding, the real star of the dining area surrounded by Kite leather chairs. The convivial area expresses peace and elegance with the Panto bookcases placed against the wall, and the Bellagio multifunctional coffee table proposed in Marble Glass. The entrance opens onto the high-performance 4You extendable console and the majestic Golden Big mirror.

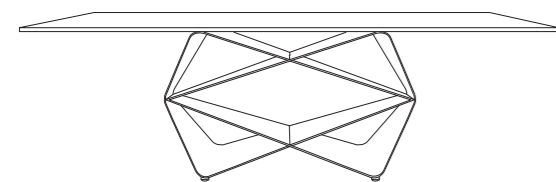

GEM

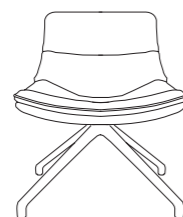

SVEVA

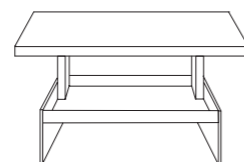

BELLAGIO

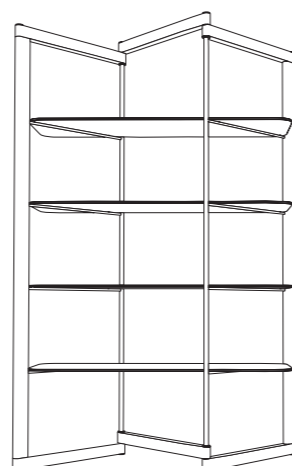

PANTO

**Tavolino multifunzione T061 BELLAGIO** piano MG02 struttura MT98 gambe CR12 / **Poltroncina S059 SVEVA** seduta P12 base MT97  
**Librerie X016B PANTO** telaio MT97 struttura PW95 ripiani CR14 - Multifunctional table T061 BELLAGIO top MG02 structure MT98 legs CR12 / Armchair S059 SVEVA covering P12 base MT97 / Bookcases X016B PANTO frame MT97 structure PW95 shelves CR14  
 Multifunktionstisch T061 BELLAGIO Platte MG02 Struktur MT98 Beine CR12 / Sessel S059 SVEVA Sitz P12 Basis MT97 / Bücherregale X016B PANTO Rahmen MT97 Struktur PW95 Regale CR14 - Table multifunction T061 BELLAGIO plateau MG02 Structure MT98 Pieds CR12  
 Fauteuil S059 SVEVA revêtement P12 base MT97 / Bibliothèques X016B PANTO Cadre MT97 Structure PW95 Etagères CR14 - Mesita transformable T061 BELLAGIO tapa MG02 estructura MT98 patas CR12 / Sillón S059 SVEVA tapizado P12 base MT97 / Librerías X016B PANTO marco MT97 estructura PW95 estantes CR14 - Многофункциональный стол T061 BELLAGIO топ MG02 структура MT98 ножки CR12 / кресло S059 SVEVA сидя P12 база MT97 / Книжные шкафы X016B PANTO рама MT97 структура PW95 полки CR14





# GEM

La semplicità dei diversi piani fluttuanti del tavolo Gem, con bordo sagomato bisellato (molatura incrociata doppio bisellatura) e bordo dritto molato filo lucido, celebrano l'essenziale dinamicità del basamento in metallo in doppia nuance cromatica o tinta unica. Il possente incastro geometrico della struttura centrale focalizza l'attenzione dell'ambiente e conferisce a questo arredo una personalità unica.

Design: Andrea Lucatello

The simplicity of the different glass tops of the Gem table, with a double shaped beveled cross grinding edge and a straight ground polished edge, highlight the essential dynamism of the metal base in a double chromatic nuance or single color. The powerful geometric interlocking of the metal base attracts the attention of the living and gives this furniture a unique personality.

Design: Andrea Lucatello

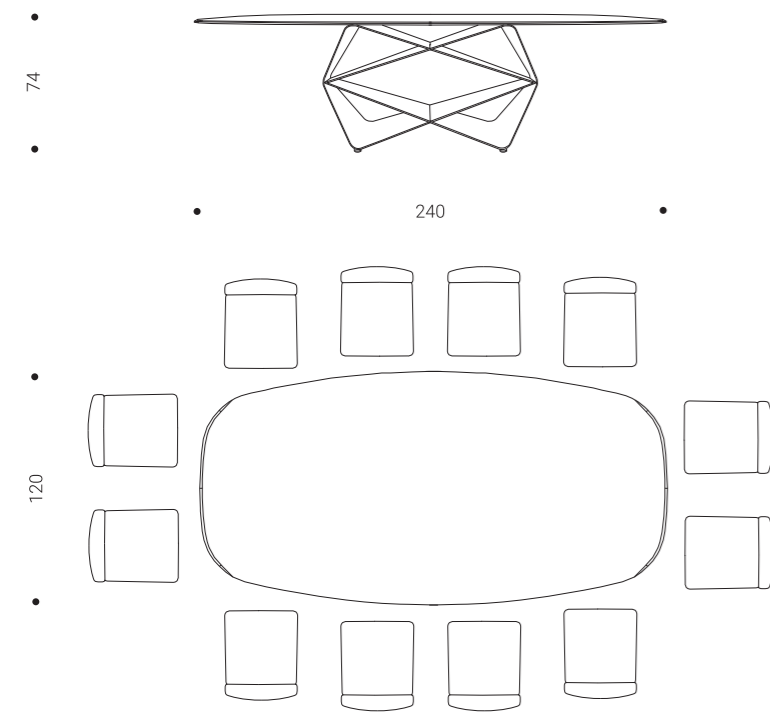

**Tavolo T234 GEM** piano CR14 base MT97, MT16 - **Table T234 GEM** top CR14 structure MT97, MT16 - **Tisch T234 GEM** Platte CR14 Struktur MT97, MT16 - **Table T234 GEM** plateau CR14 Structure MT97, MT16 - **Mesa T234 GEM** top CR14 base MT97, MT16 - **Настольная T234 GEM** top CR14 Настольная база MT97, MT16







**Tavolo T234 GEM** piano CR14 base MT97, MT16 / **Sedie S336 KITE** rivestimento C30 - **Table T234 GEM** top CR14 structure MT97, MT16 / **Chairs S336 KITE** covering C30 - **Tisch T234 GEM** Platte CR14 Struktur MT97, MT16 / **Stühle S336 KITE** Bezug C30 - **Table T234 GEM** plateau CR14 Structure MT97, MT16 / **Chaises S336 KITE** revêtement C30 - **Mesa T234 GEM** top CR14 base de mesa MT97, MT16 / **Sillas S336 KITE** tapizado C30 - **Настольная T234 GEM** top CR14 **Настольная база** MT97, MT16 / **Стулья S336** Обивка КИТ C30





# GOLDEN BIG

Versione "Big" del noto specchio Golden wood. La cornice in legno massello dislocata dal proprio asse originario movimentata la pura staticità di questo complemento. Posizionabile a parete in orizzontale o verticale, è pensato per completare la progettazione dell'ambiente domestico e contract moderno.

Design: Andrea Lucatello

"Big" version of the well-known Golden wood mirror. The solid wood frame misaligned from its original axis enlivens the pure stillness of this complement. It can be positioned horizontally or vertically on the wall, and is conceived to complete the design of the modern home and contract project.

Design: Andrea Lucatello

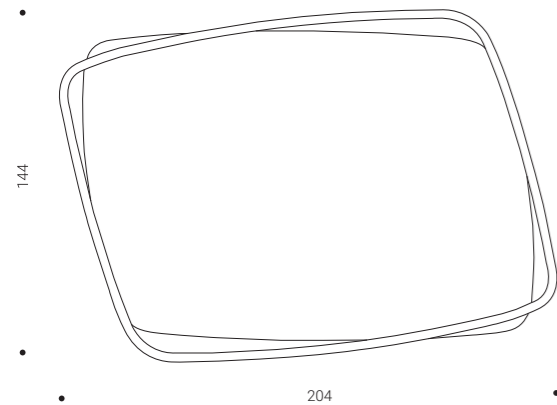

**Specchio X039 GOLDEN BIG** cornice PW96 – **Mirror X039 GOLDEN BIG** Frame PW96 - **Spiegel X039 GOLDEN BIG** rahmen PW96 - **Miroir X039 GOLDEN BIG** cadre PW96 - **Espejo X039 GOLDEN BIG** marco PW96 - **Зеркало X039 GOLDEN BIG** обрамлять PW96

# 4YOU



Perfetta per ogni ambiente, la consolle allungabile 4YOU è l'arredo che combina forma e funzione.

Le tre allunghe a libro, celate all'interno del raffinato piano in legno, permettono di ospitare fino a 10 commensali. Base in metallo geometricamente incastonata e sistema brevettato con guide in leggero alluminio.

Design: Giulio Manzoni  
Prodotto Brevettato

Perfect for any environment, the extendable console "4YOU" is the furniture that combines shape and function.

The three folding extensions, hidden inside the refined wooden top, can accommodate up to 10 guests. Geometric metal base and patented system with light aluminum guides.

Design: Giulio Manzoni  
Patented Product

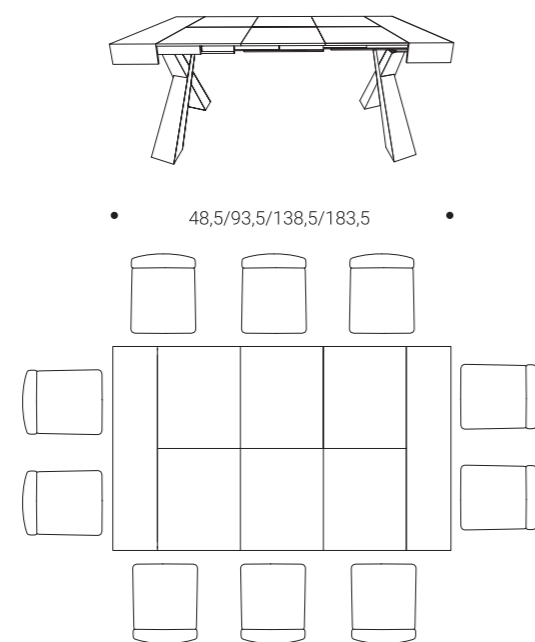
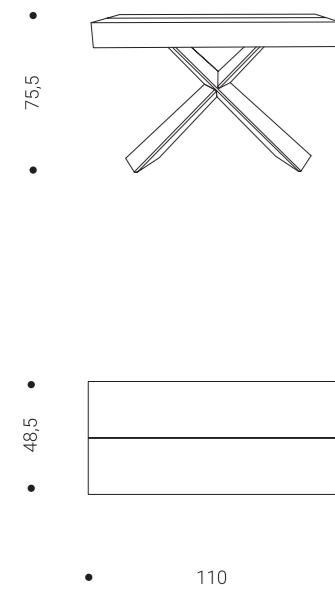

Consolle T024 4YOU piano PW96 base MT97 - Console T024 4YOU top PW96 structure MT97 - Konsole T024 4YOU oben PW96 Struktur MT97 - Console T024 4YOU plateau PW96 base MT97 - Consola T024 4YOU top PW96 base MT97 - T024 4YOU плоская PW96 база MT97 консольный стол



# BELLAGIO



Il tavolino multifunzionale Bellagio è un pratico complemento polivalente per l'arredamento del living contemporaneo. Il piano elevabile ammortizzato consente di utilizzarlo come tavolino da soggiorno, o in posizione elevata quale versatile appoggio per colazione, gioco, notebook... e molte altro.

The Bellagio multifunctional coffee table is a practical multi-purpose item for the contemporary living room. The elevating top allows it to be used as a living room coffee-table, or in the lift up position as a versatile support for breakfast, games, notebooks... and much more.

Design: Marco Pozzoli  
Prodotto Brevettato

Design: Marco Pozzoli  
Prodotto Brevettato

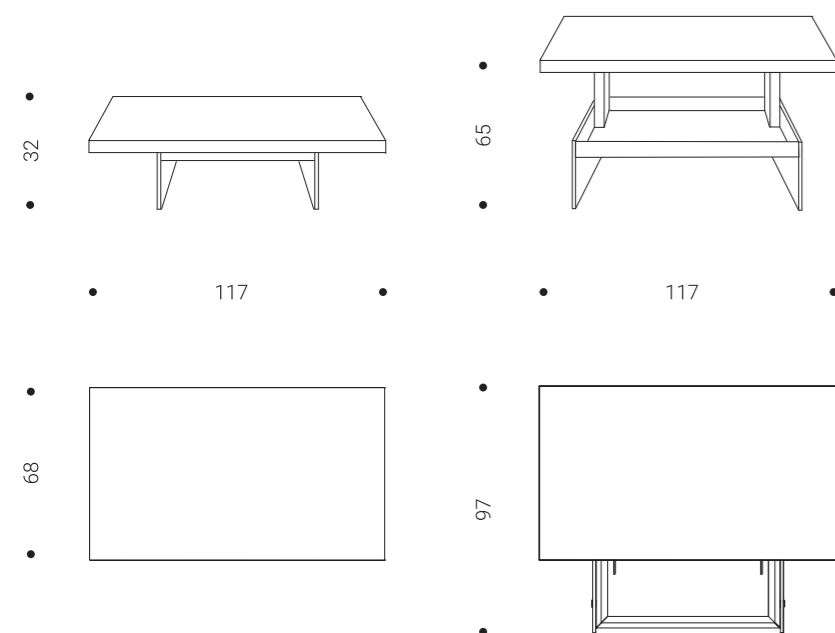

**Tavolino multifunzione T061 BELLAGIO** piano MG02 struttura MT98 gambe CR12 - Multifunctional table T061 BELLAGIO top MG02 structure MT98 legs CR12 - Multifunktionstisch T061 BELLAGIO Platte MG02 Struktur MT98 Beine CR12 - Table multifonction T061 BELLAGIO plateau MG02 Structure MT98 Pieds CR12 - Mesita transformable T061 BELLAGIO top MG02 estructura MT98 patas CR12 Многофункциональный стол T061 BELLAGIO top MG02 структура MT98 ножки CR12





**Tavolino multifunzione T061 BELLAGIO** piano MG02 struttura MT98 gambe CR12 - Multifunctional table T061 BELLAGIO top MG02 structure MT98 legs CR12 - Multifunktionstisch T061 BELLAGIO Platte MG02 Struktur MT98 Beine CR12  
Table multifonction T061 BELLAGIO plateau MG02 Structure MT98 Pieds CR12 - Mesita transformable T061 BELLAGIO top MG02 estructura MT98 patas CR12 - Многофункциональный стол T061 BELLAGIO top MG02 структура MT98 ножки CR12



# STELLA, SALLY, SVEVA

Una famiglia di poltroncine dalla seduta morbida e avvolgente, presentate con diversi rivestimenti. Le cuciture sullo schienale ne disegnano le forme e lasciano trasparire la morbidezza. Basamenti diversi, sia nel disegno che nel materiale, offrono molteplici possibilità di abbinamenti per soddisfare ogni ambiente e circostanza.

A family of armchairs with a soft and cosy seat, presented with different covers. The seams on the backrest design the shapes and let the softness shine through. Different bases, both in design and material, offer multiple possibilities of combinations to satisfy every environment and circumstance.

Design: Marco Pozzoli

Design: Marco Pozzoli

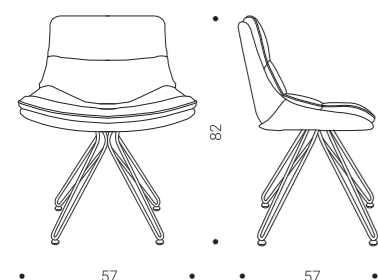

STELLA

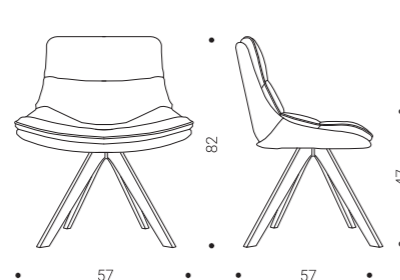

SALLY

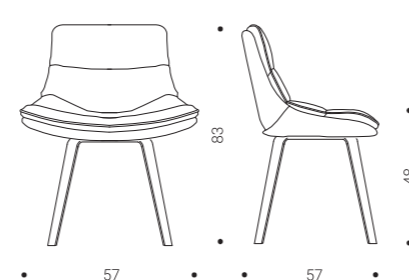

SELENA

**Poltroncine S057 STELLA** seduta VE04 base MT98, **S058 SALLY** seduta P10 base PW91, **S060 SELENA** seduta P12 base PW96 - Armchairs S057 STELLA covering VE04 base MT98, S058 SALLY covering P10 base PW91, S060 SELENA covering P12 base PW96 - Sessel S057 STELLA Sitz VE04 Untergestell MT98, S058 SALLY Sitz P10 Untergestell PW91, S060 SELENA Sitz P12 Untergestell PW96 - Fauteuils S057 STELLA revêtement VE04 base MT98, S058 SALLY revêtement P10 base PW91, S060 SELENA revêtement P12 base PW96 - Sillón S057 STELLA tapizado VE04 base MT98, Sillón S058 SALLY tapizado P10 base PW91, Sillón S060 SELENA tapizado P12 base PW96 - Кресла S057 STELLA сиденье VE04 основание MT98, сиденье S058 SALLY P10 основание PW91, S060 SELENA сиденье P12 основание PW96



## LOFT PORTA VENEZIA

Arioso loft con zona giorno open space e zona notte soppalcata a vista, delineata da un'elegante balaustra in vetro. Gli sgabelli Milo dalla morbida seduta, decorano la penisola, mentre una consolle Golia funge da comodo scrivtorio e angolo studio/lavoro. I protagonisti della zona relax sono i sorprendenti pouf Cubix, in grado di trasformarsi fino a formare cinque sedute, quattro delle quali dotate di comodo schienale. Il complemento Cubix si completa perfettamente attorno al tavolo trasformabile Box proposto nella nuova finitura in Marble Glass.

Airy loft with open space living area and open mezzanine sleeping area, outlined by an elegant glass balustrade. Milo stools with soft seats decorate the peninsula, while a Golia console serves as a comfortable desk and study / work corner. The stars of the relax area are the surprising Cubix poufs, which can transform into five seats, four of which have a comfortable backrest. Cubix matches perfectly around the Box transformable coffee table shown in the new Marble Glass finish.

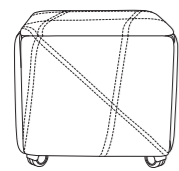

CUBIX

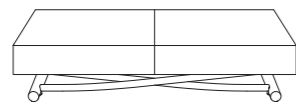

BOX

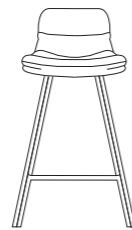

MILO

**Pouf trasformabili S011 CUBIX** rivestimento EP90, VE03 con cuciture a contrasto, struttura MT97 / **Tavolino trasformabile T110 BOX** piano MG01 struttura MT97 / **Sgabelli S503 MILO** seduta P11 base MT97 - Transformable pouf S011 CUBIX covering EP90, VE03 with contrast stitching, MT97 structure / Transformable coffee table T110 BOX top MG01 structure MT97 / Stools S503 MILO seat P11 base MT97 - Umwandelbare Sitzsack S011 CUBIX bezug EP90, VE03 mit Kontrastnähten, Struktur MT97 / Umwandelbarer Couchtisch T110 BOX Platte MG01 Struktur MT97 / Hocker S503 MILO Sitz P11 Untergestell MT97 - Poufs transformables S011 CUBIX avec EP90, VE03 avec coutures contrastées, structure MT97 / Table basse transformable T110 BOX plan MG01 structure MT97 / Tabourets S503 MILO siège P11 structure MT97 - Otomanos transformables S011 CUBIX con EP90, VE03 con costura de contraste, estructura MT97 / Mesa de centro transformable T110 BOX top MG01 estructura MT97 / Taburetes S503 MILO asiento P11 base MT97 - Оттоманы S011 CUBIX трансформируемые с EP90, VE03 с контрастной строчкой, структура MT97 / T110 BOX трансформируемый журнальный столик MG01 top структура MT97 / S503 MILO стулья P11 основание сиденья MT97







# CUBIX



Sorprendente, trasformabile, indispensabile, sono solo alcuni degli aggettivi che descrivono al meglio questo innovativo complemento. L'avveniristico studio di intersezioni cela all'interno cinque sedute, quattro delle quali progettate per essere utilizzate come comode sedie dotate di poggia schiena imbottito. Articolo insostituibile per la praticità di utilizzo, dotato di quattro ruote per una facile movimentazione oltre che a elegante progetto di doppia cucitura per semplificare il riposizionamento in sede delle sedute.

Surprising, transformable, essential, are just some of the adjectives that best describe this innovative item. The futuristic study of intersections hides five chairs inside, four of which are comfortable chairs with upholstered backrests. A unique item easy to use, equipped with four sliding wheels for easy handling, and an elegant double stitching design to simplify the opening and closing system.

Design: Giulio Manzoni  
Prodotto Brevettato

Design: Giulio Manzoni  
Prodotto Brevettato

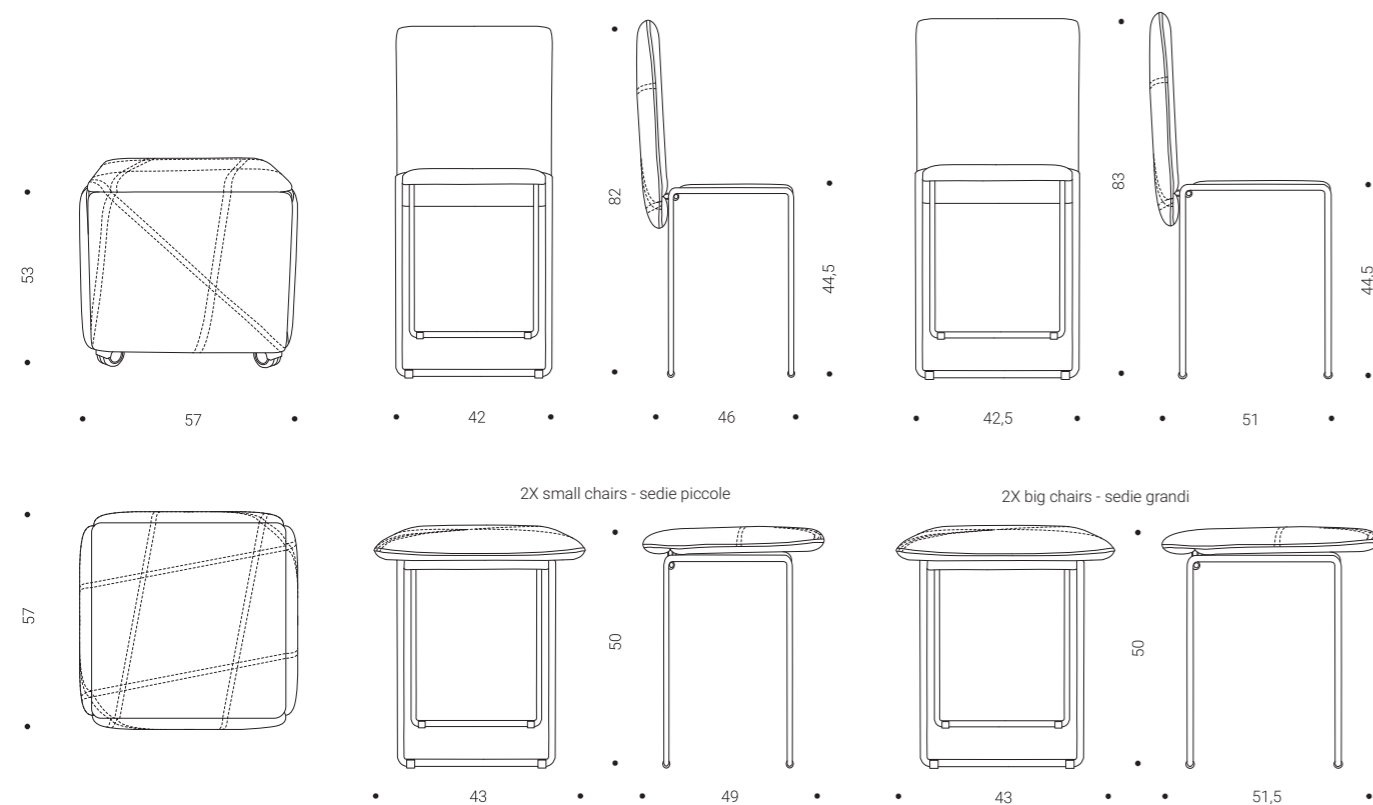

**Pouf trasformabile S011 CUBIX** rivestimento EP90 con cuciture a contrasto, struttura MT97 - Transformable pouf S011 CUBIX covering EP90 with contrast stitching, MT97 structure Umwandelbare - Ottomane S011 CUBIX mit EP90 mit Kontrastnähten, Struktur MT97 - Pouf transformable S011 CUBIX revêtement EP90 avec coutures en contrast, structure MT97 - Pouf transformables S011 CUBIX con EP90 con costura de contraste, estructura MT97 - Оттоманы S011 CUBIX трансформируемые с EP90 с контрастной строчкой, структура MT97





**Pouf trasformabile S011 CUBIX** rivestimento EP90 con cuciture a contrasto, struttura MT97 / **Tavolino trasformabile T110 BOX** piano MG01 struttura MT97 - Transformable pouf S011 CUBIX covering EP90 with contrast stitching, MT97 structure / Transformable coffee table T110 BOX top MG01 structure MT97 - Umwandelbare Ottomane S011 CUBIX mit EP90 mit Kontrastnähten, Struktur MT97 / Umwandelbarer Couchtisch T110 BOX Platte MG01 Struktur MT97 - Pouf transformable S011 CUBIX revêtement EP90 avec coutures en contraste, structure MT97 / Table basse transformable T110 BOX plateau MG01 structure MT97 - Pouf transformables S011 CUBIX con EP90 con costura de contraste, estructura MT97 / Mesa de centro transformable T110 BOX top MG01 estructura MT97 - Оттоманы S011 CUBIX трансформируемые с EP90 с контрастной строчкой, структура MT97 / T110 BOX трансформируемый журнальный столик MG01 top структура MT97



LA TRASFORMABILITA' DI CUBIX  
CUBIX TRANSFORMABILITY



1

POUF TRASFORMABILE DOTATO DI ROTELLE PER UNA FACILE MOVIMENTAZIONE. UTILIZZABILE COME SEDUTA ANCHE COMPLETAMENTE "CHIUSO". L'ELEGANTE DOPPIA CUCITURA SEMPLIFICA IL RIPOSIZIONAMENTO IN SEDE DELLE QUATTRO SEDUTE INTERNE.

TRANSFORMABLE POUF EQUIPPED WITH CASTORS FOR EASY HANDLING. IT CAN BE USED AS A SITTING WHEN COMPLETELY "CLOSED". THE ELEGANT DOUBLE STITCHING SIMPLIFIES THE REPOSITIONING OF THE FOUR INTERNAL SEATS.

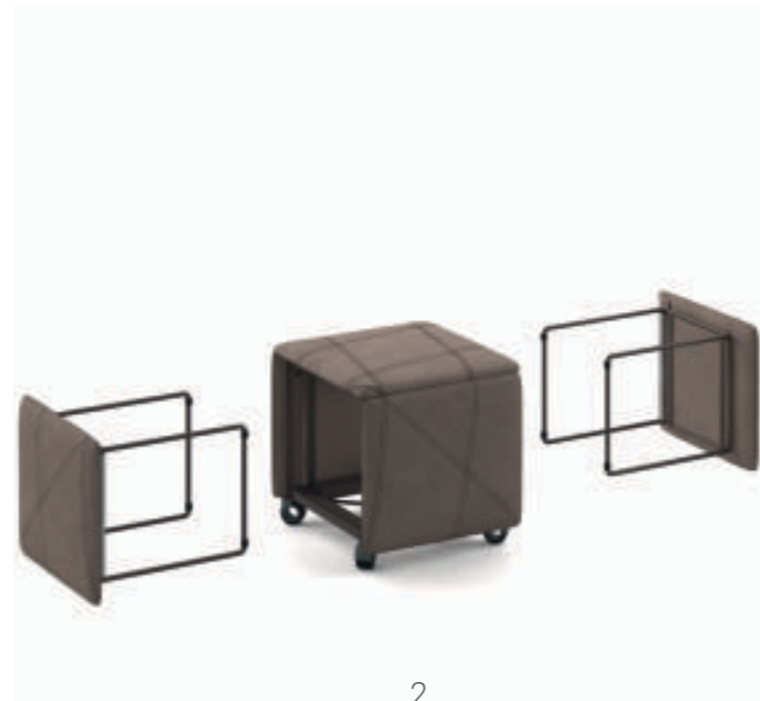

2

L'ESTRAZIONE DELLE SEDUTE È PRATICA E INTUITIVA. È POSSIBILE UTILIZZARE IL NUMERO DI SEDUTE DESIDERATO, LASCIANDO ALL'INTERNO DEL POUF QUELLE CHE NON RISULTANO NECESSARIE

THE EXTRACTION OF THE SITTINGS IS PRACTICAL AND INTUITIVE. IT IS POSSIBLE TO USE THE NUMBER OF SITTINGS NEEDED AND LEAVE THE OTHER ONES STORED INSIDE THE POUF.



3

LE QUATTRO SEDUTE INTERNE, UNA VOLTA ESTRATTE, POSSONO ESSERE UTILIZZATE ANCHE SENZA L'AUSILIO DELLO SCHIENALE, MA COME SEMPLICI SGABELLI.

THE FOUR INTERNAL SITTINGS, ONCE EXTRACTED, CAN ALSO BE USED WITHOUT THE BACKREST BUT AS SIMPLE STOOLS.



4

PER UN MAGGIORE CONFORT E COMPLETA LIBERTÀ DI UTILIZZO, LE QUATTRO SEDUTE INTERNE SONO DOTATE DI UN MORBIDO SCHIENALE IMBOTTITO. MENTRE IL POUF CON ROTELLE PUÒ ESSERE UTILIZZATO ANCH'ESSO COME SEDUTA O COME TAVOLINO DA APPOGGIO.

FOR GREATER COMFORT AND COMPLETE FREEDOM OF USE, THE FOUR INTERNAL SITTINGS ARE EQUIPPED WITH A PADDED BACKREST. WHILE THE POUF WITH CASTORS CAN ALSO BE USED AS A STOOL OR AS A COFFEE TABLE.



DOTATO DI MECCANISMO DI CHIUSURA "SOFT CLOSING".  
EQUIPPED WITH "SOFT CLOSING" MECHANISM.

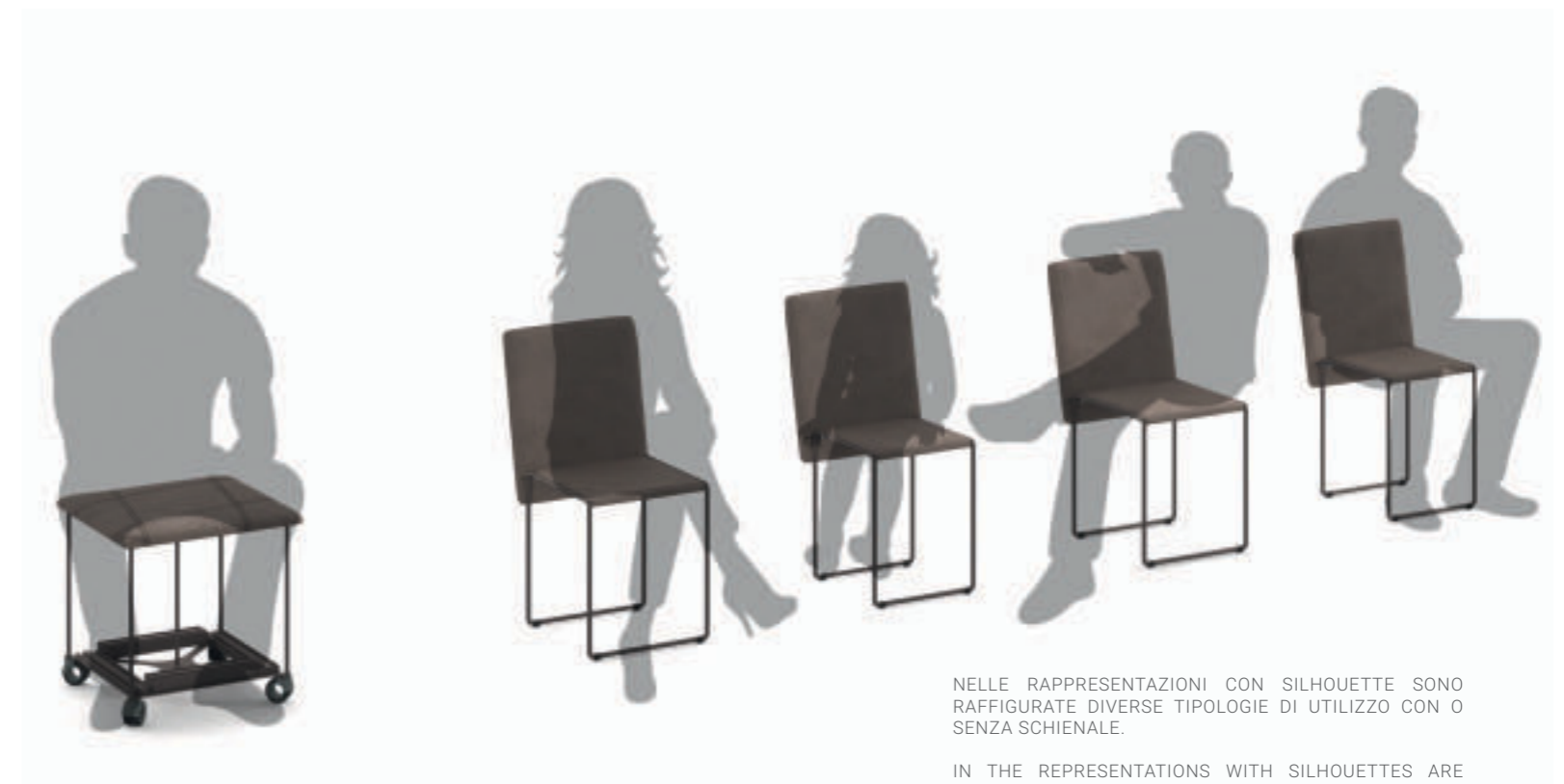

NELLE RAPPRESENTAZIONI CON SILHOUETTES SONO RAFFIGURATE DIVERSE TIPOLOGIE DI UTILIZZO CON O SENZA SCHIENALE.

IN THE REPRESENTATIONS WITH SILHOUETTES ARE DISPLAYED SEVERAL TYPES OF USE, WITH OR WITHOUT BACKREST ACCORDING TO CUSTOMER NEEDS

# BOX



Il top seller Box si rinnova attraverso la preziosa finitura Marble Glass. Iconico e multifunzione, questo tavolino trasformabile dall'aspetto essenziale, è il cuore pulsante della convivialità domestica. Allunghe abilmente celate all'interno del piano, apertura telescopica sincronizzata, alzata assistita al millimetro con pistone a gas e ruote a scomparsa per una discreta movimentazione all'interno della zona living.

Design: Studio Ozeta  
Prodotto Brevettato

The top seller "Box" is renewed through the precious Marble Glass finishing. Iconic and multifunctional, this transformable table with an essential appearance is the beating heart of domestic conviviality. Extensions cleverly hidden inside the top, synchronized telescopic opening, millimeter-assisted lift with gas piston and hidden wheels for an easy movement in the living area.

Design: Studio Ozeta  
Patented Product

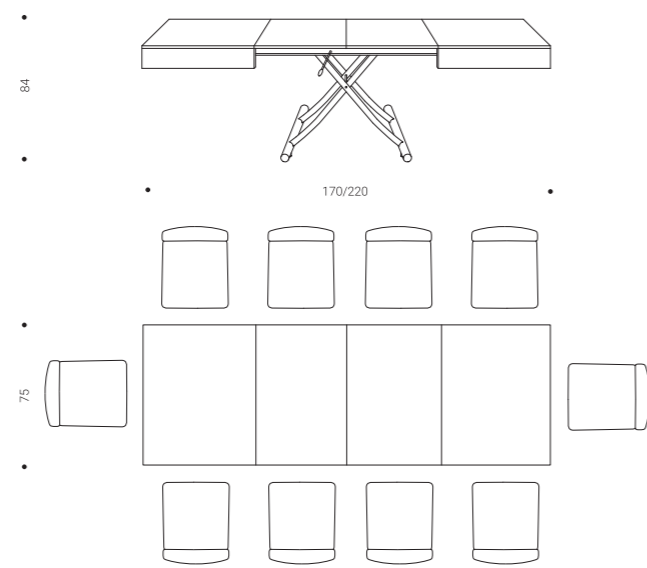
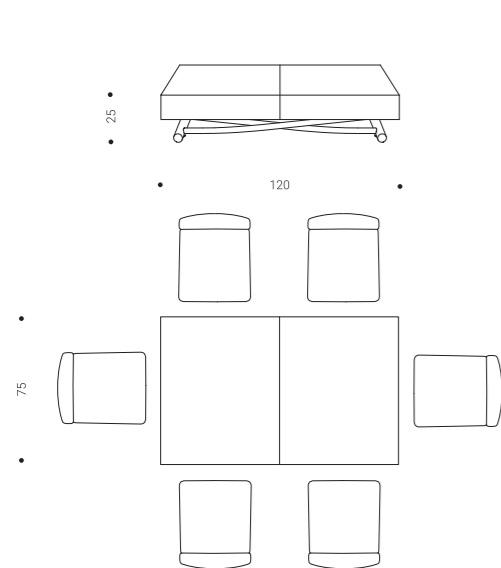

**Tavolino trasformabile T110 BOX** piano MG01 struttura MT97 - Transformable coffee table T110 BOX top MG01 structure MT97  
Umwandelbarer Couchtisch T110 BOX Platte MG01 Struktur MT97 - Table transformable T110 BOX plateau MG01 structure MT97 - Mesa de centro transformable T110 BOX top MG01 estructura MT97 - BOX трансформируемый журнальный столик MG01 top структура MT97

**Pouf trasformabili S011 CUBIX** rivestimento EP90, VE03 con cuciture a contrasto, struttura MT97 / **Tavolino trasformabile T110 BOX** piano MG01 struttura MT97 / **Sgabelli S503 MILO** seduta P11 base MT97 - Transformable poufs S011 CUBIX covering EP90, VE03 with contrast stitching, MT97 structure / Transformable coffee table T110 BOX top MG01 structure MT97 / Stools S503 MILO covering P11 base MT97 - Umwandelbare Ottomane S011 CUBIX mit EP90, VE03 mit Kontrastnähten, Struktur MT97 / Umwandelbarer Couchtisch T110 BOX Platte MG01 Struktur MT97 / Hocker S503 MILO Sitz P11 Untergestell MT97 - Poufs transformables S011 CUBIX revêtement EP90,



VE03 avec coutures en contrast, structure MT97 / Table basse transformable T110 BOX plateau MG01 structure MT97 / Tabourets S503 MILO revêtement P11 structure MT97 - Pouf transformables S011 CUBIX tapizado en EP90, VE03 con costura de contraste, estructura MT97 / Mesa de centro transformable T110 BOX top MG01 estructura MT97 / Taburetes S503 MILO tapizado P11 base MT97 - Оттоманы S011 CUBIX трансформируемые с EP90, VE03 с контрастной строчкой, структура MT97 / T110 BOX трансформируемый журнальный столик MG01 топ структура MT97 / S503 MILO стулья P11 основание сиденья MT97



# MORFEO, MORGAN, MORRIS, MARLON

Una famiglia di sgabelli comodi ed avvolgenti realizzati per un living caldo e moderno.

Gli sgabelli Morfeo, Morgan, Morris e Marlon sono accomunati da una seduta imbottita dall'effetto cosy e da una cucitura che fa trasparire il loro morbido rivestimento. Diversi basamenti, fissi e regolabili con pistone a gas, ne conferiscono diverse personalità, le quali possono essere ulteriormente personalizzate nelle finiture.

A family of comfortable stools made for a friendly and modern living.

The Morfeo, Morgan, Morris and Marlon stools have in common a cosy padded seat and a stitching that makes their softness upholstery very appealing. Several bases, fixed and adjustable with gas piston, give them different personalities, which can be further customized in finishes.

Design: Marco Pozzoli

Design: Marco Pozzoli

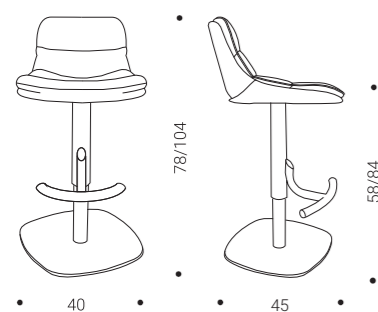

MORFEO

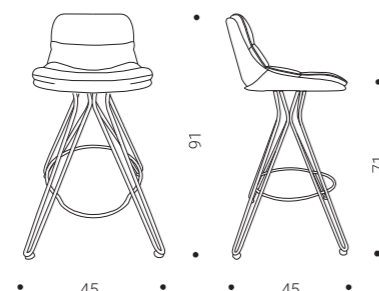

MORGAN

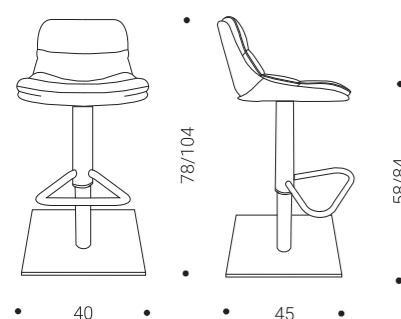

MORRIS

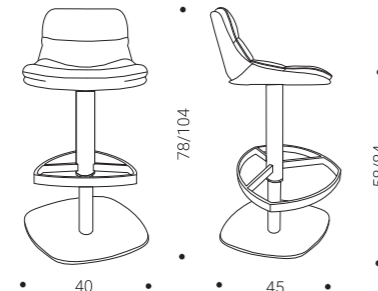

MARLON

**Sgabello S512 MORFEO** seduta P10 base MT99 / **Sgabello S504 MORGAN** seduta VE03 base MT97 / **Sgabello S511 MORRIS** seduta P18 base MT98 / **Sgabello S513 MARLON** seduta P11 base MT97 - Stool S512 MORFEO covering P10 base MT99 / Stool S504 MORGAN covering VE03 base MT97 / Stool S511 MORRIS covering P18 base MT98 / Stool S513 MARLON covering P11 base MT97 - Hocker S512 MORFEO sitzend P10 Sockel MT99 / Hocker S504 MORGAN sitzend VE03 Sockel MT97 / Hocker S511 MORRIS sitzend P18 Sockel MT98 / Hocker S513 MARLON sitzend P11 Sockel MT97 - Tabouret S512 MORFEO revêtement P10 base MT99 / Tabouret S504 MORGAN revêtement VE03 base MT97 / Tabouret S511 MORRIS revêtement P18 base MT98 / Tabouret S513 MARLON revêtement P11 base MT97 Taburete S512 MORFEO tapizado P10 base MT99 / Taburete S504 MORGAN tapizado VE03 base MT97 / Taburete S511 MORRIS sentado P18 base MT98 / Taburete S513 MARLON sentado P11 base MT97 - Стул S512 MORFEO сидящий P10 база MT99 / Стул S504 MORGAN сидящий VE03 база MT97 / Стул S511 MORRIS сидящий P18 база MT98 / Стул S513 MARLON сидящий P11 база MT97



# GOLIA



Minimal ma dalla personalità multiforme l'iconica consolle allungabile Golia si ripropone in versione laccato opaco poro aperto. Piani, gambe e allunghe in legno, meccanismo telescopico in alluminio e dotata di 5 prolunghe esterne di 50 cm, laccate in tinta. La gamba centrale presenta una doppia funzione: sostegno centrale a consolle aperta e la rotazione di 180°, per favorire la libertà di seduta di tutti i commensali.

Minimal but with a versatile personality, the iconic Golia extendable console is presented in an open pore matt lacquered version. Wooden tops, legs and extensions, telescopic mechanism in aluminum and equipped with 5 external extensions of 50 cm each, lacquered in the same color. The central pivoting leg has a double function: support the top while the console is open, to give extra room sitting for all guests.

Design: Marco Pozzoli & Giacomo Mauri  
Prodotto Brevettato

Design: Marco Pozzoli & Giacomo Mauri  
Patented Product

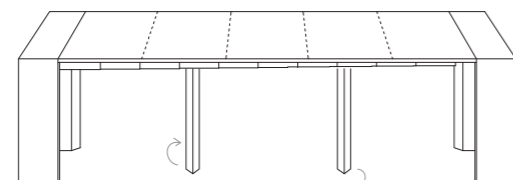
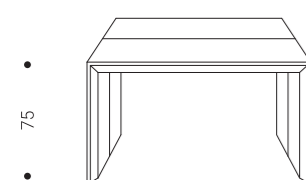

• 100 •

• 93/143/193/242/293 •

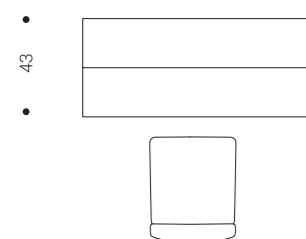

**Pouf trasformabile S011 CUBIX** rivestimento VE03 con cuciture a contrasto, struttura MT97 / **Consolle T035 GOLIA** struttura e allunghe PW96 - Transformable pouf S011 CUBIX covering VE03 with contrast stitching, MT97 structure / Console T035 GOLIA structure and extensions PW96 - Umwandelbare Ottomane S011 CUBIX mit VE03 mit Kontrastnähten, Struktur MT97 / Konsole T035 GOLIA Struktur und Erweiterungen PW96 - Pouf transformables S011 CUBIX revêtement VE03 avec coutures en contrast, structure MT97 / Console T035 GOLIA structure et rallonges PW96 – Pouf transformables S011 CUBIX tapizado VE03 con costura de contraste, estructura MT97 / Consola T035 GOLIA estructura y extensiones PW96 - Оттоманы S011 CUBIX трансформируемые с VE03 с контрастной строчкой, структура MT97 / Консоль T035 GOLIA структура и удлинители PW96





## PALAZZO FLORENTIA

Salotto di design e multifunzionalità grazie al tavolino trasformabile Su e Giù con piano e gambe legno. Il motivo "Shanghai" della struttura catalizza completamente l'attenzione di quest'area polifunzionale. Le sedie pieghevoli vengono comodamente riposte con un gancio a parete dedicato. Il pouf Cubix offre le sedute aggiuntive che risultano indispensabili una volta che il tavolino si trasforma in un comodo tavolo da pranzo che può ospitare fino a otto commensali.

Design and multifunctional living room thanks to the transformable table Su e Giù with wooden top and legs. The "Shanghai" design of the structure completely captures the attention of this multifunctional area. The folding chairs can easily be stored with a dedicated hook on the wall. The seats of the Cubix pouf are essential once the coffee table is open and becomes a comfortable dining table for up to eight guests.

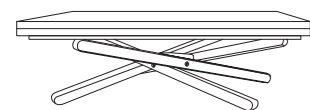

SU E GIU'

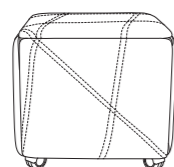

CUBIX

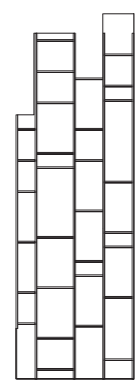

BYBLOS

**Tavolino trasformabile T101 SU e GIÙ** piano e struttura PW94 / **Pouf trasformabile S011 CUBIX** rivestimento VE05 con cuciture a contrasto, struttura MT97 / **Libreria X026 BYBLOS** struttura X01 - Transformable coffee table T101 SU e GIÙ top and structure PW94 / Transformable pouf S011 CUBIX covering VE05 with contrast stitching, MT97 structure / Bookcase X026 BYBLOS structure X01 - Cabrio Couchtisch T101 SU e GIÙ Oberseite und Struktur PW94 / Umwandelbare Ottomane S011 CUBIX mit VE05 mit Kontrastnähten, Struktur MT97 / Bücherregal X026 BYBLOS Struktur X01 - Table de salon transformable T101 SU e GIÙ plateau et structure PW94 / Pouf transformables S011 CUBIX avec VE05 avec coutures en contrast, structure MT97 / Bibliothèque X026 BYBLOS Structure X01 - Mesa de centro Transformable T101 SU e GIÙ tapa y estructura PW94 / Pouf transformables S011 CUBIX con VE05 con costura de contraste, estructura MT97 / Librería X026 BYBLOS Estructura X01 - Трансформируемый журнальный столик T101 SU e GIÙ, верх и структура PW94 / Оттоманы S011 CUBIX трансформируемые с VE05 с контрастной строчкой, структура MT97 / Книжный шкаф X026 Структура BYBLOS X01





# SU E GIU'



Tavolino da salotto che diventa tavolo da pranzo, per la prima volta completamente in legno. Il basamento incrociato, regolabile a tutte le altezze al millimetro, si armonizza con il piano allungabile a libro. Questo eccezionale complemento d'arredo è in grado di fondersi completamente con l'ambiente living, infatti il gioco di incroci del basamento elevabile crea un connubio perfetto tra design ed efficienza.

Coffee table that becomes a dining table, completely made of wood for the first time. The crossed base, adjustable at any height, perfectly matches with the extendable folding top. This extraordinary piece of furniture is able to harmoniously stand out with the living environment, in fact the game of intersections of the elevating base creates a perfect combination of design and efficiency.

Design: Giulio Manzoni  
Prodotto Brevettato

Design: Giulio Manzoni  
Patented Product

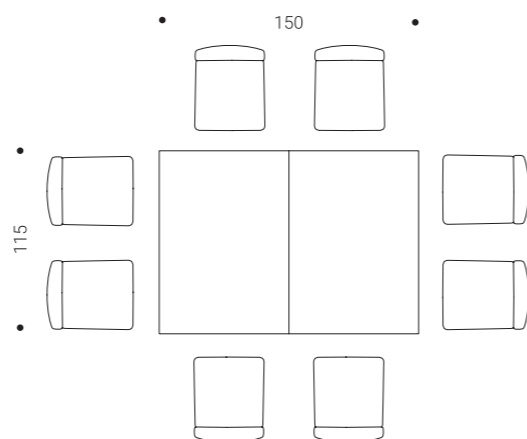
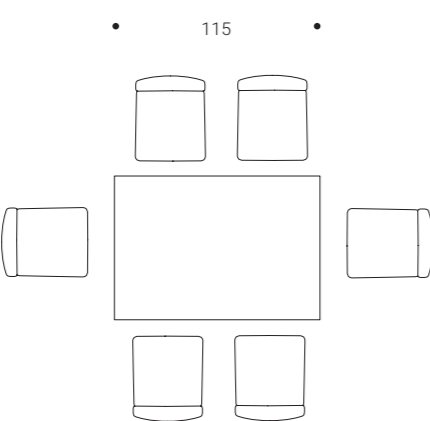
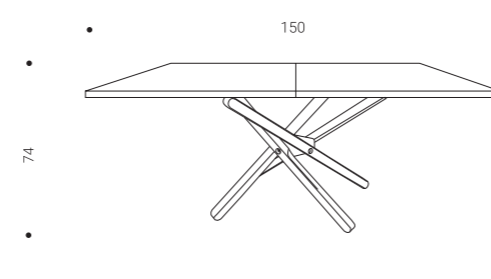
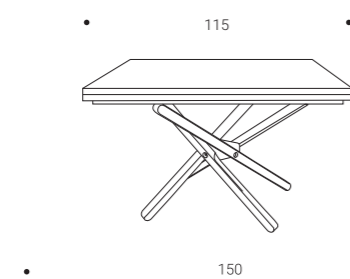
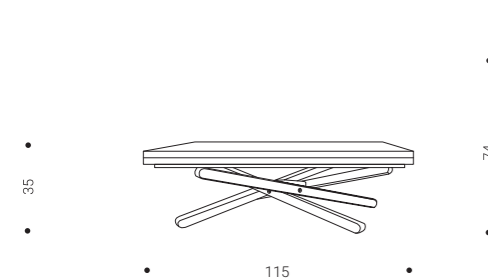

**Tavolino trasformabile T101 SU e GIÚ** piano e struttura PW94 - Transformable coffee table T101 SU e GIÚ top and structure PW94 - Cabrio Couchtisch T101 SU e GIÚ Oberseite und Struktur PW94 - Table de salon transformable T101 SU e GIÚ plateau et structure PW94 - Mesa de centro convertible T101 SU e GIÚ tара y estructura PW94 - Трансформируемый журнальный столик T101 SU e GIÚ, верх и структура PW94

**Tavolino trasformabile T101 SU e GIÙ** piano e struttura PW94 / **Pouf trasformabile S011 CUBIX** rivestimento VE05 con cuciture a contrasto, struttura MT97 - Transformable coffee table T101 SU e GIÙ top and structure PW94 / Transformable pouf S011 CUBIX covering VE05 with contrast stitching, MT97 structure - Cabrio Couchtisch T101 SU e GIÙ Oberseite und Struktur PW94 / Umwandelbare Ottomane S011 CUBIX mit VE05 mit Kontrastnähten, Struktur MT97 - Table de salon transformable T101 SU e GIÙ plateau et structure PW94 / Pouf

transformable S011 CUBIX revêtement VE05 avec coutures en contrast, structure MT97 - Mesa de centro transformable T101 SU e GIÙ tapa y estructura PW94 / Pouf transformables S011 CUBIX tapizado VE05 con costura de contraste, estructura MT97 - Трансформируемый журнальный столик T101 SU e GIÙ, верх и структура PW94 / Оттоманы S011 CUBIX трансформируемые с VE05 с контрастной строчкой, структура MT97



# RIPIEGO

Elegante e salvaspazio, la seduta Ripiego è in grado di mimetizzarsi in solo 90cm di altezza per 7 di spessore da chiusa. Le sue pregiate finiture in legno e vitrex si sposano con la robusta struttura in metallo cromato o verniciato. La sedia pieghevole Ripiego risulta facilmente riponibile fino a 6 pezzi all'interno del Carrello Ripiego (Codice S216), o a parete con il Gancio Nobys-Ripiego (Codice S210).

Design: Giuliano Cappelletti Architetto & Studio Ozeta

Elegant and space-saving, the Ripiego chair is able to blend into just 90cm high by 7 thick when closed. Its precious wood and vitrex finishes are combined with the strong structure in chromed or painted metal. The folding chair Ripiego can be easily stored up to 6 pieces inside the Ripiego Trolley holder (Code S216), or on the wall with the Nobys-Ripiego Hook (Code S210).

Design: Giuliano Cappelletti Architetto & Studio Ozeta

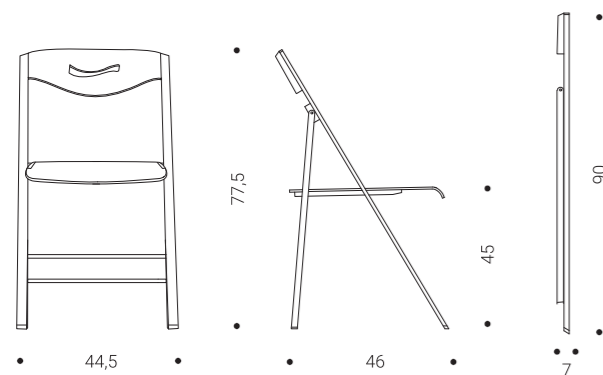

**Sedie pieghevoli S215 RIPIEGO** sedute PW96, VX90, PW94 struttura MT97 - Folding chairs S215 RIPIEGO seat PW96, VX90, PW94 structure MT97 - Klappstühle S215 RIPIEGO PW96, VX90, PW94 Strukturen MT97 - Chaises pliantes S215 RIPIEGO Sièges PW96, VX90, PW94 structure MT97 - Sillas plegables S215 RIPIEGO Asientos PW96, VX90, PW94 estructuras MT97 - Складные стулья S215 RIPIEGO Сиденья PW96, VX90, PW94 конструкции MT97



## VILLA TRAMAGLINO

Interno luminoso e ricercato per questo progetto di Interior design che racchiude l'evoluzione stilistica del pluripremiato tavolo best seller 4x4. Il nuovo progetto, uscito dal laboratorio R&D di Ozzio Italia, racchiude prestazioni impensabili nel sorprendente tavolo Big Round. Caratterizzato dalla perfetta sovrapposizione di incastri e allunghe in legno, è presentato dalla nuova essenza legno Dark Grey e padroneggia la sala da pranzo minimal mentre si trasforma secondo le necessità di utilizzo. La nuova finitura legno si ritrova nella madia Alizée posizionata nel salotto adiacente. La forma armoniosa della base Big Round richiama le preziose cuciture a contrasto della sedia Loren qui presentata in cuoio. La libreria Byblos si presenta completamente rivoluzionata nella nuova finitura spazzolata Bronzo Seta.

Bright and elegant environment for this Interior design project that introduces the evolution of the award-winning best-selling 4x4 table. The new project, developed by the Ozzio Italia R&D lab, contains unimaginable performances in the surprising Big Round table. Characterized by the perfect overlapping of joints and wooden extensions, it is presented with the new Dark Gray wood finishing that masters the minimalist dining room as it transforms according to the needs of use. The new wood finish is shown again in the Alizée sideboard placed in the near living room. The harmonious shape of the Big Round base recalls the precious stitching of the Loren chair here shown in leather. The Byblos bookcase is completely renewed in the new brushed silk bronze finish.

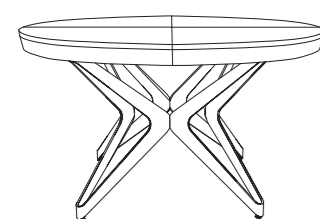

BIG ROUND

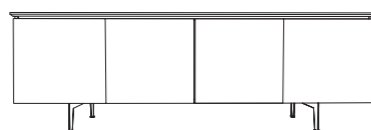

ALIZEE

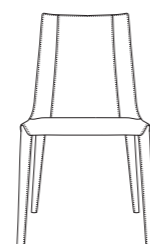

LOREN

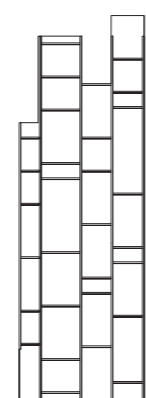

BYBLOS

**Tavolo T232 BIG ROUND** piano PZ94 base MT97 / **Sedie S337 LOREN** rivestimento C32 / **Libreria X026 BYBLOS** struttura X18 / **Madia X300 ALIZÉE** top e ante PZ94 fianchi X06 piedi MT98 - Table T232 BIG ROUND top PZ94 base MT97 / Chairs S337 LOREN covering C32 Bookcase X026 BYBLOS structure X18 / Sideboard X300 ALIZÉE top and doors PZ94 sides X06 feet MT98 - Tisch T232 BIG ROUND Platte PZ94 Untergestell MT97 / Stühle S337 LOREN Polsterung C32 / Bücherregal X026 BYBLOS Struktur X18 / Schrank X300 ALIZÉE Oberseite und Türen PZ94 Seiten X06 Fuß MT98 - Mesa T232 BIG ROUND plateau PZ94 base MT97 / Chaises S337 LOREN revêtement C32 Bibliothèque X026 BYBLOS structure X18 / Bahut X300 ALIZÉE plateau et portes PZ94 côtés X06 pieds MT98 - Mesa T232 BIG ROUND top PZ94 base MT97 / Sillas S337 LOREN tapizado C32 / Librería X026 BYBLOS estructura X18 / Aparador X300 ALIZÉE tapa y puertas PZ94 laterales X06 pies MT98 - Настольный T232 BIG ROUND top PZ94 база MT97 / Стулья S337 LOREN обивка C32 / Книжный шкаф X026 БИБЛОС структура X18 / Комод X300 ALIZÉE верх и двери PZ94 по бокам X06 ножек MT98





# BIG ROUND



Il tavolo allungabile Big Round è l'evoluzione a tutto tondo del top di gamma 4x4. Il meccanismo di apertura brevettato è composto da una perfetta sovrapposizione di incastri solidamente trattenuti tra loro. Il sofisticato disegno delle gambe conferisce al prodotto resistenza e personalità. Un'attenzione particolare dedicata alla finitura rovere vecchio naturale esaltata dall'intarsio centrale che si mostra solo a tavolo completamente aperto.

The "Big Round" extendable table is the ultimate evolution of the top seller 4x4 family.

The patented opening mechanism is composed of a perfect overlapping of solidly held joints. The sophisticated design of the legs gives the product strength and personality.

Particular attention is paid to the natural old oak finish enhanced by the central inlay that is only shown when the table is fully open.

Design: Marco Pozzoli e Andrea Lucatello  
Prodotto Brevettato

Design: Marco Pozzoli e Andrea Lucatello  
Prodotto Brevettato

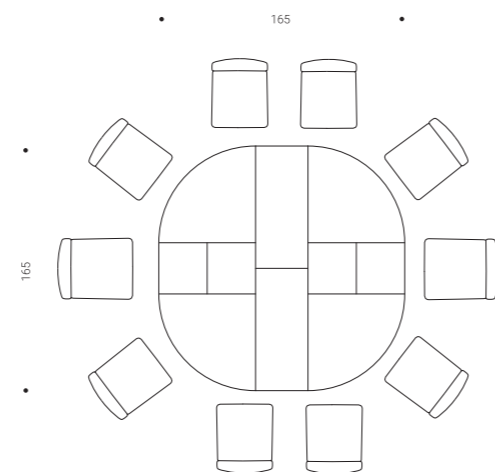
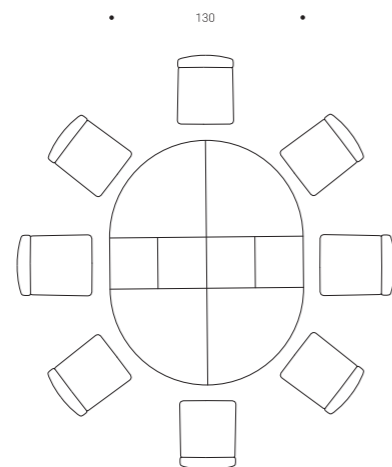
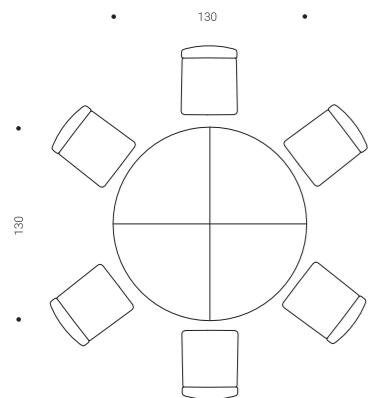
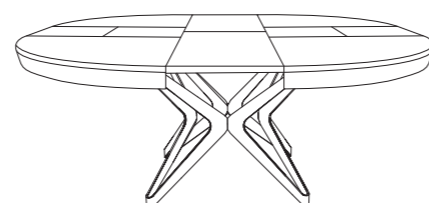
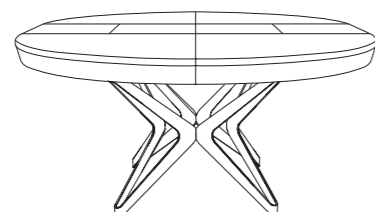
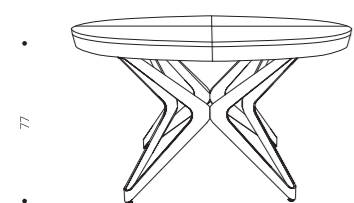

**Tavolo T232 BIG ROUND** piano PZ94 base MT97 - Table T232 BIG ROUND top PZ94 base MT97 - Tisch T232 BIG ROUND Platte PZ94 Untergestell MT97 - Table T232 BIG ROUND plateau PZ94 base MT97 Mesa T232 BIG ROUND top PZ94 base MT97 - Настольный T232 BIG ROUND top PZ94 база MT97





**Tavolo T232 BIG ROUND** piano PZ94 base MT97 / **Sedie S337 LOREN** rivestimento C32 - Table T232 BIG ROUND top PZ94 base MT97  
Chairs S337 LOREN covering C32 - Tisch T232 BIG ROUND Platte PZ94 Untergestell MT97 / Stühle S337 LOREN Polsterung C32 - Table  
T232 BIG ROUND plateau PZ94 base MT97 / Chaises S337 LOREN revêtement C32 - Mesa T232 BIG ROUND top PZ94 base MT97 / Sillas  
S337 LOREN tapizado C32 - Настольный T232 BIG ROUND top PZ94 база MT97 / Стулья S337 LOREN обивка C32

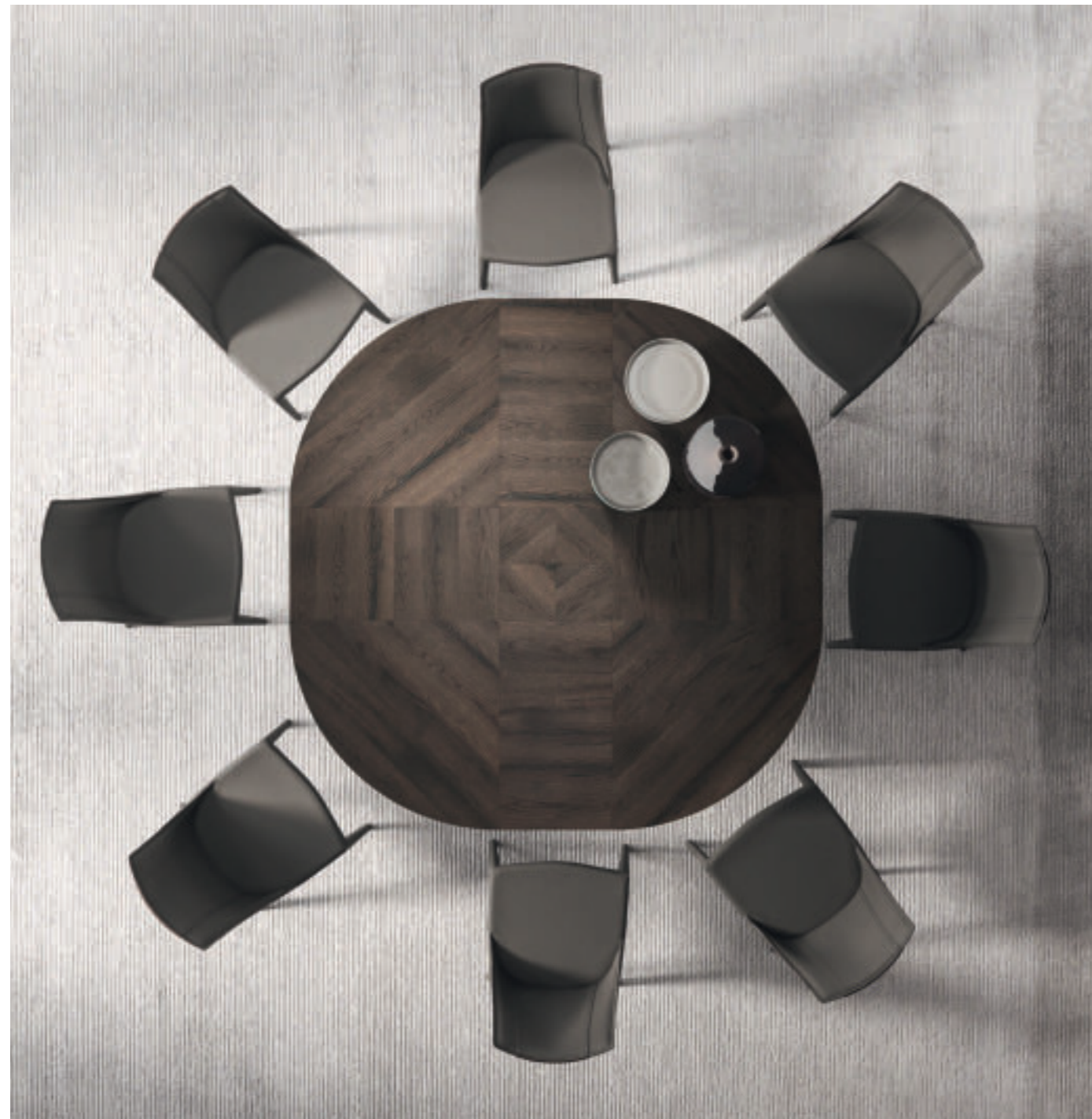

## TAVOLO BIG ROUND - CHIUSO

NELLA VERSIONE CHIUSA SI PRESENTA COME UNO SCULTOREO TAVOLO DA PRANZO DALLE DIMENSIONI CONTENUTE ATTO AD OSPITARE FINO A SEI PERSONE. NELLA PAGINA ACCANTO È RAPPRESENTATO A SINISTRA CON VERSIONE IN ROVERE WILD, PIÙ A DESTRA IN FINITURA ROVERE VECCHIO. LA DIVERSA DIREZIONE DI VENATURA DELLE DUE VERSIONI È UNA PURA SCELTA STILISTICA.

### BIG ROUND - CLOSED

WHEN CLOSED IT LOOKS LIKE A SCULPTURAL DINING TABLE WITH SMALL DIMENSIONS SUITABLE TO ACCOMMODATE UP TO SIX PEOPLE. ON THE NEXT PAGE IT IS REPRESENTED ON THE LEFT WITH WILD OAK FINISHING AND ON THE RIGHT IN ANCIENT OAK FINISH. THE DIFFERENT GRAIN DIRECTION OF THE TWO VERSIONS IS A PURE STYLISTIC CHOICE



## TAVOLO BIG ROUND - SEMIAPERTO

IL TAVOLO SI ESTENDE GRAZIE AD UN SISTEMA DI ALLUNGHE CENTRALI NASCOSTE, TRASFORMANDOSI FINO AD OSPITARE COMODAMENTE OTTO COMMENSALI. IL PRIMO STEP È CARATTERIZZATO DA DUE ALLUNGHE CENTRALI DOTATE DI APERTURA AGEVOLATA A SLITTAMENTO. IL SENSO DI VENA DEL LEGNO DELLE ALLUNGHE MUTA A SECONDA DELLA FINITURA DEL TOP.

### BIG ROUND - SEMI OPEN

THE TABLE EXTENDS THANKS TO A SYSTEM OF HIDDEN CENTRAL EXTENSIONS, TRANSFORMING ITSELF TO COMFORTABLY ACCOMMODATE EIGHT GUESTS. THE FIRST STEP IS CHARACTERIZED BY TWO CENTRAL EXTENSIONS WITH AN EASY-SLIDING OPENING SYSTEM. THE DIRECTION OF THE GRAIN CHANGES ACCORDING TO THE FINISHING OF THE TOP.



## TAVOLO BIG ROUND - APERTO

GRAZIE AL SISTEMA BREVETTATO DI APERTURA A TRASLAZIONE INDIPENDENTE, IL TOP SI ALLARGA ULTERIORMENTE E L'ALLUNGA CENTRALE ESCE SORPRENDENTEMENTE ALLO SCOPERTO CREANDO UNA GEOMETRIA RADDOPPIATA RISPETTO ALLA PARTENZA, PERMETTENDO DI OSPITARE FINO A 10 COMMENSALI. UNA VOLTA COMPLETAMENTE APERTO IL TAVOLO REGALA UN PREZIOSO INTARSIO CENTRALE PRESENTE SOLO NELLE FINITURE IN ROVERE VECCHIO. (PZ91, PZ93 E PZ94)

### BIG ROUND - OPEN

THANKS TO THE OPENING PATENTED SYSTEM WITH INDEPENDENT TRANSLATION, THE TOP OPENS WIDER AND THE CENTRAL EXTENSION GETS OUT SURPRISINGLY, CREATING A GEOMETRY DOUBLED COMPARED TO THE START POSITION, ALLOWING TO ACCOMMODATE UP TO TEN GUESTS. ONCE COMPLETELY OPEN THE TABLE GIVES A PRECIOUS CENTRAL INLAY AVAILABLE IN THE ANCIENT OLD FINISHES ONLY. (PZ91, PZ93 AND PZ94)

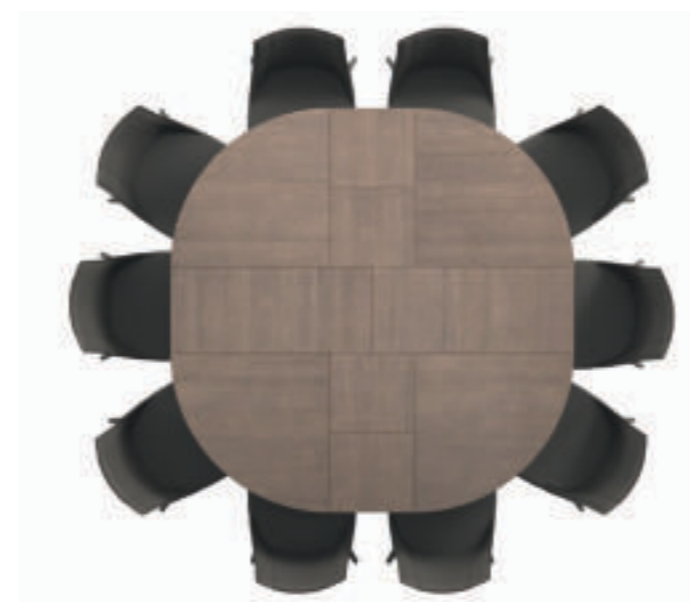

# BYBLOS

Byblos è una libreria modulare orientabile sia in orizzontale che in verticale. Composta da una struttura in MDF laccato con aggancio invisibile. È possibile affiancare infiniti elementi oppure collocarla semplicemente singolarmente. La nuova finitura "graffiata" nella tinta del laccato bronzo seta le dona note forti e decise

Design: Studio Ozeta

Byblos is a modular bookcase that can be oriented both horizontally and vertically. Made of an MDF lacquered structure with invisible hooking system. It is possible to place lot of elements side by side or simply place it individually. The new "scratched" lacquer finishing in the shade of silk bronze gives it a strong character.

Design: Studio Ozeta

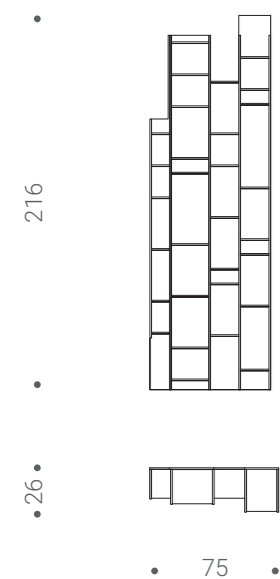

Libreria X026 BYBLOS struttura X18 - Bookcase X026 BYBLOS structure X18 - Bücherregal X026 BYBLOS Struktur X18 - Bibliothèque X026 BYBLOS structure X18 - Librería X026 BYBLOS estructura X18 - Книжный шкаф X026 BYBLOS структура X18



LEGENDA FINITURE  
FINISHES LEGEND

**METALLI | METALS**

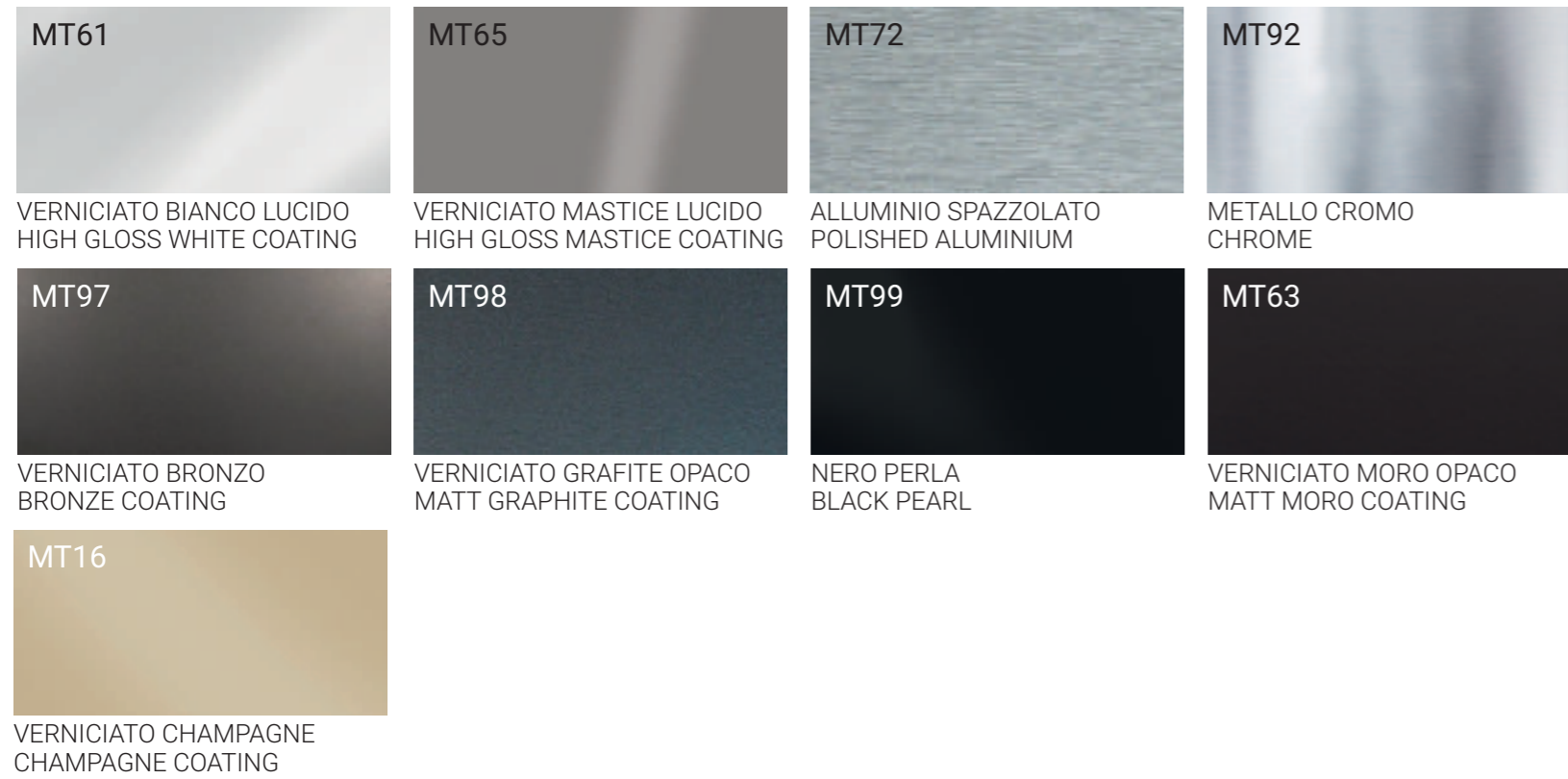

**LACCATI | LACQUERS**

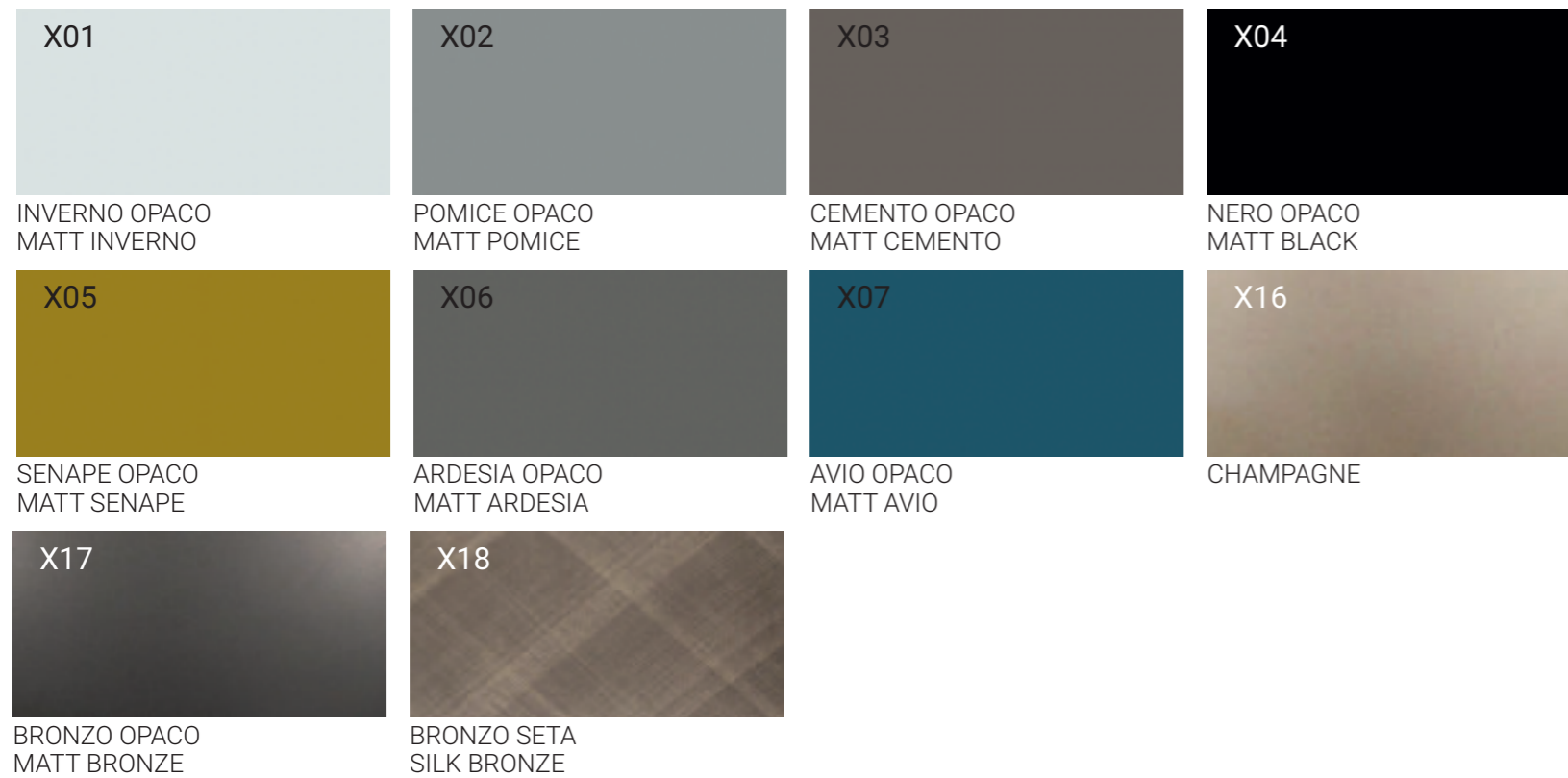

**CEMENTI | CEMENTS**

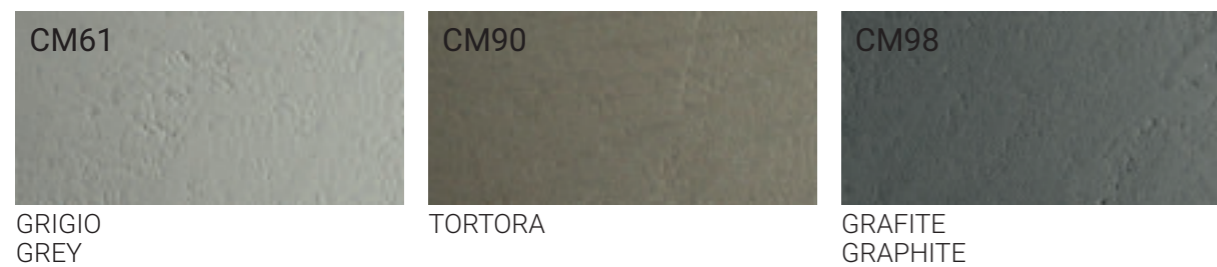

**LEGNI | WOODS**

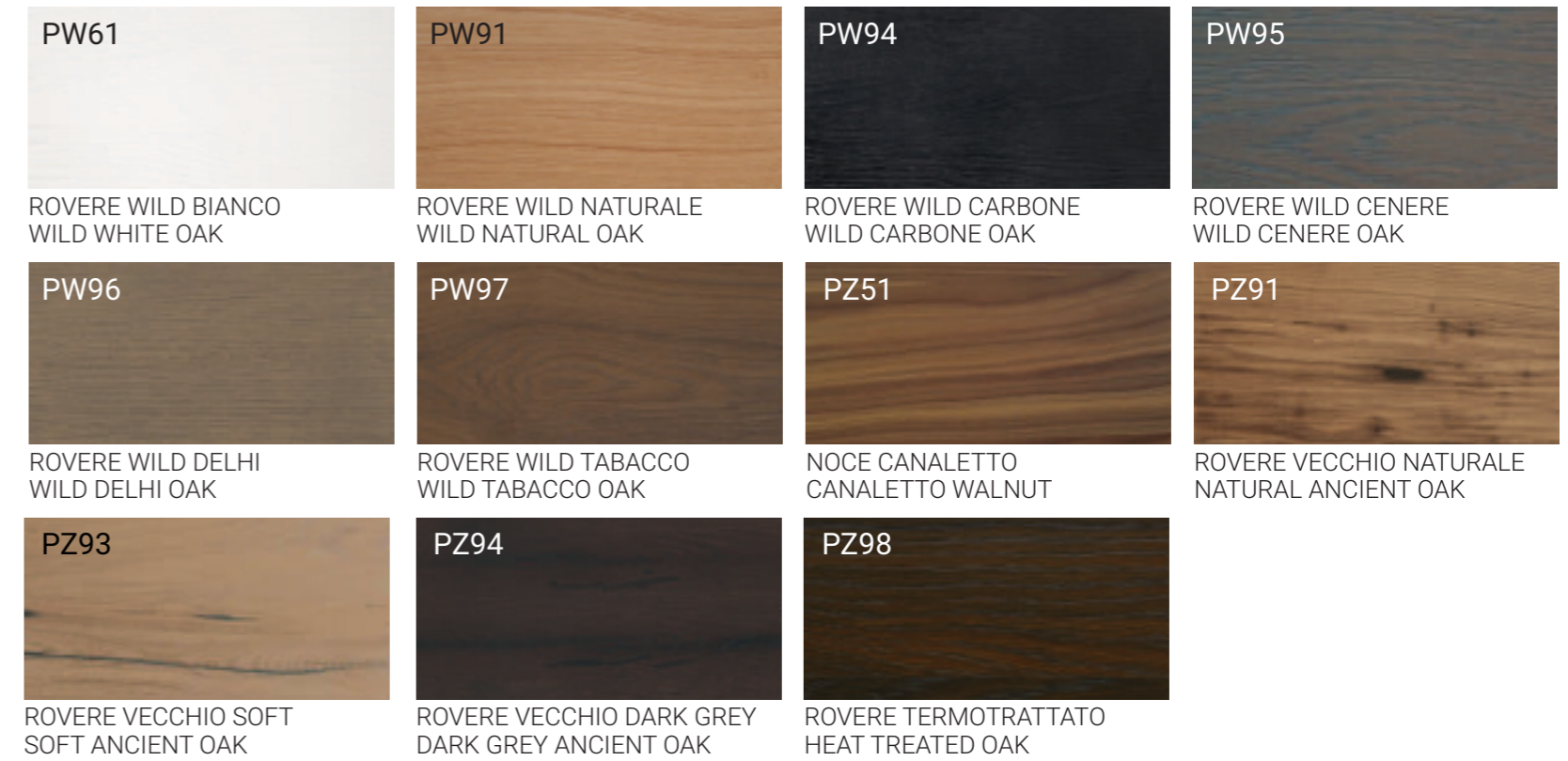

**ECO LEGNO | ECO WOOD**



**LAMINA | LAYER**

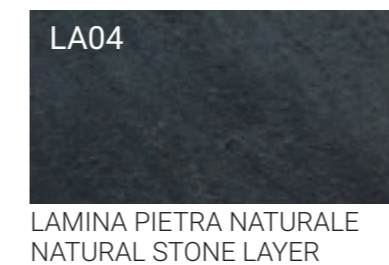

## MARBLE GLASS



CALACATTA GOLD



SAHARA NOIR

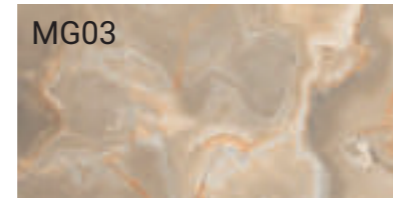

ONICE

## CRISTALLI COLORATI | COLOURED GLASS



EXTRACHIARO  
EXTRAWHITE

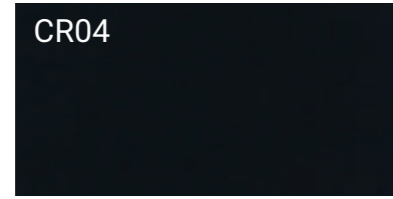

ANTRACITE  
ANTHRACITE

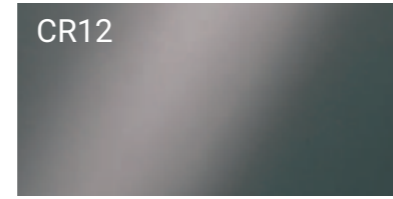

FUMÉ



TRASPARENTE EXTRACHIARO  
EXTRAWHITE TRANSPARENT

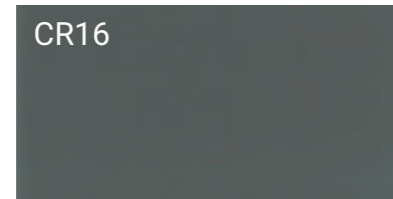

CREMA CAFFÉ  
COFFEE CREAM



FLOAT

## CRISTALLI ANTIMPRONTA | MARK-LESS GLASS

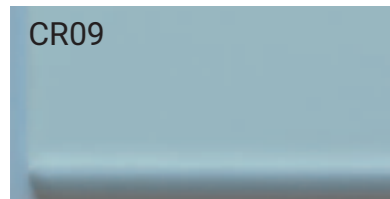

ANTIMPRONTA BIANCO  
MARK-LESS WHITE

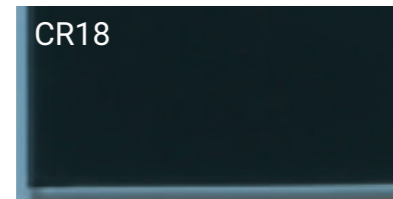

ANTIMPRONTA GRAFITE  
MARK-LESS GRAPHITE

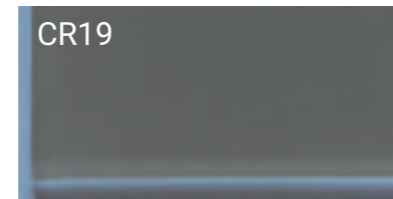

ANTIMPRONTA CREMA CAFFÉ  
MARK-LESS COFFEE CREAM

## CRISTALLI CERAMICA | PYROCERAM GLASS

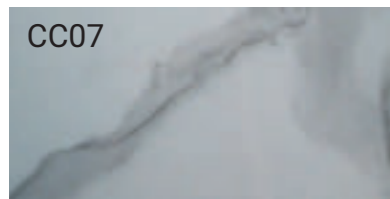

CALACATTA

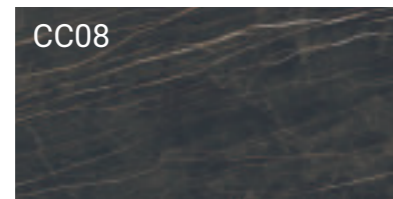

NOIR DESIR



EMPERADOR

## POLIPROPILENE | POLYPROPYLENE

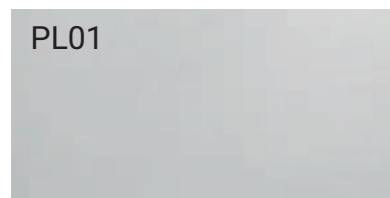

BIANCO  
WHITE

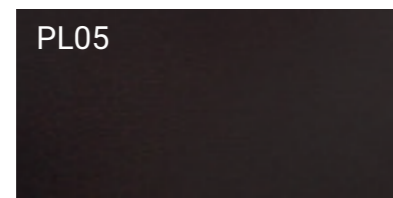

MOKA

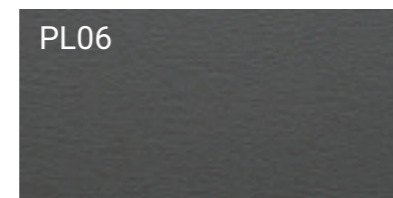

MASTICE

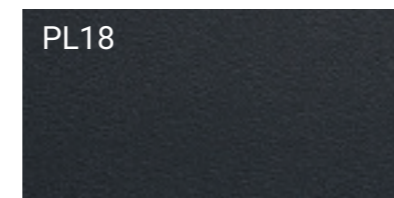

GRAFITE  
GRAPHITE

## VITREX LUCIDO | GLOSSY VITREX

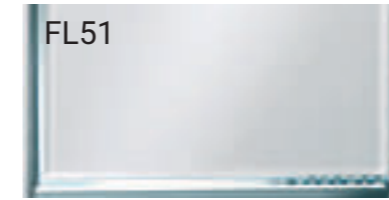

NEUTRO  
NEUTRAL



ARANCIO  
ORANGE



ROSSO  
RED

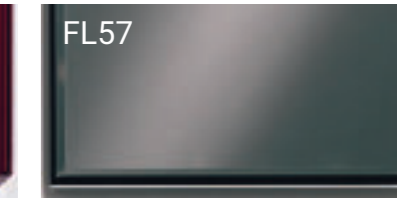

FUMÉ

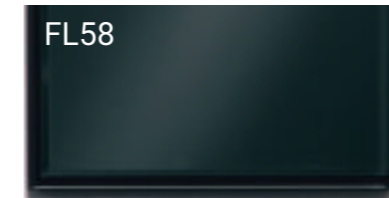

PETROLIO

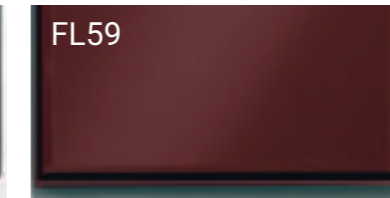

COLA

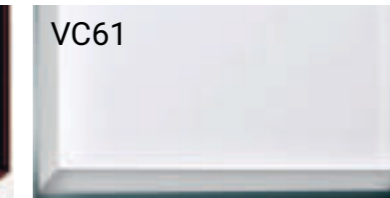

BIANCO COPRENTE  
OPAQUE WHITE

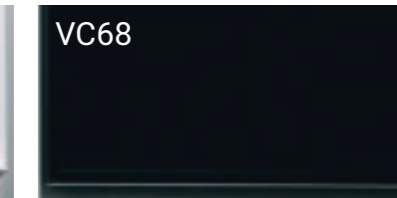

NERO COPRENTE  
OPAQUE BLACK

## VITREX SABBIAATO | FROSTED VITREX

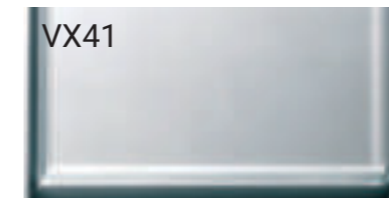

GHIACCIO

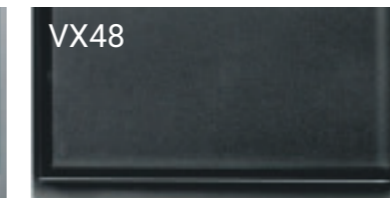

NERO  
BLACK

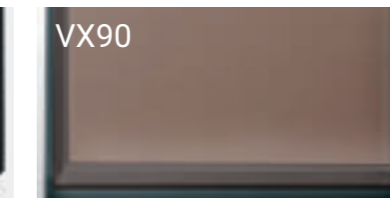

TORTORA

## VELVET

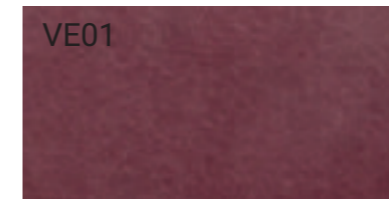

ROSA  
PINK

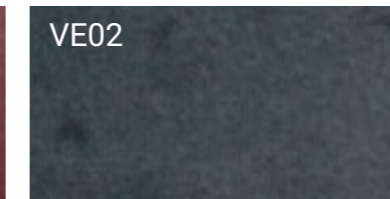

GRIGIO  
GREY

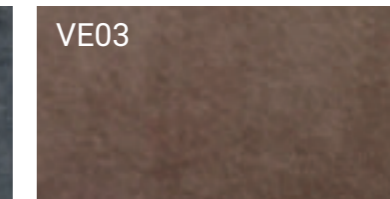

CASTORO

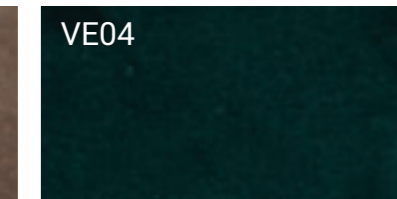

SMERALDO

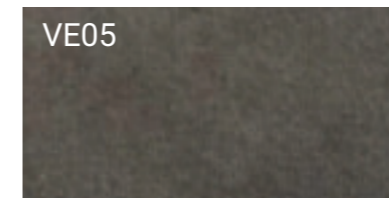

CORDA

## CUOIO | LEATHER

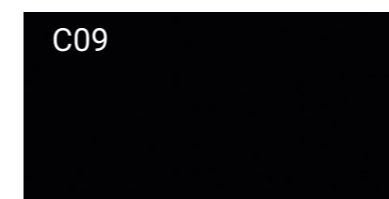

NERO  
BLACK

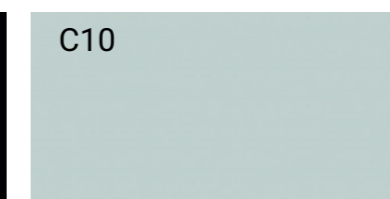

BIANCO  
WHITE

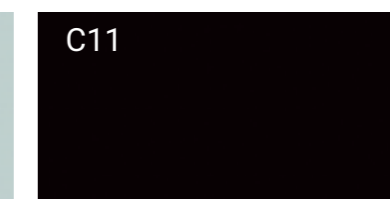

MOKA

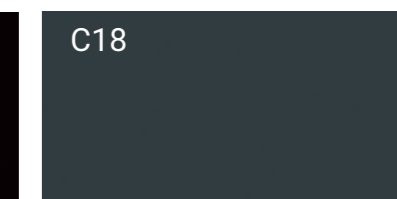

GRAFITE  
GRAPHITE

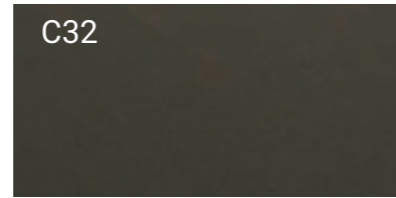

C30  
CREMA CAFFÉ  
COFFEE CREAM

C31  
KHAKI

C32  
PIOMBO

**PELLE | SOFT LEATHER**

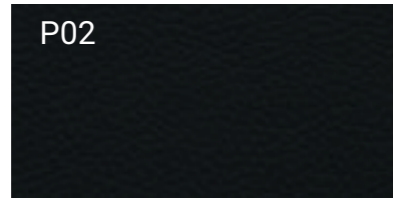

P01  
BIANCO  
WHITE

P02  
NERO  
BLACK

P10  
MOKA

P11  
MASTICE

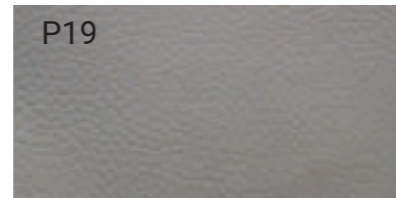
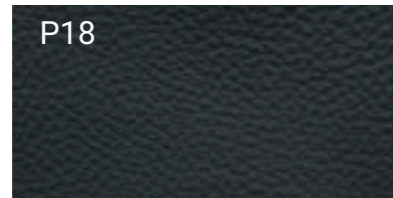

P12  
CREMA CAFFÉ  
COFFEE CREAM

P18  
GRAFITE  
GRAPHITE

P19  
POLVERE

P20  
HAVANA

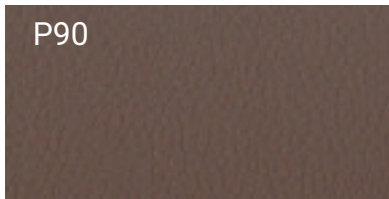

P90  
FANGO

**ECO PELLE | SOFT ECO LEATHER**

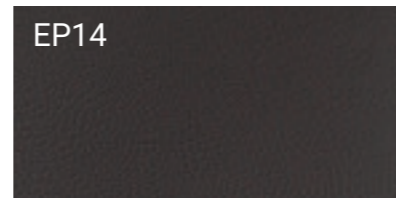
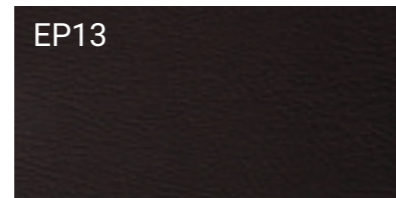
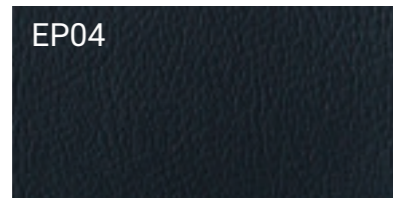
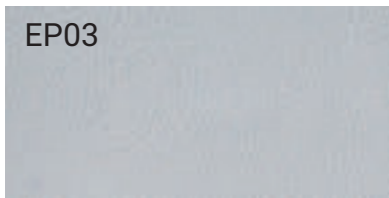

EP03  
BIANCO  
WHITE

EP04  
NERO  
BLACK

EP13  
MOKA

EP14  
MASTICE

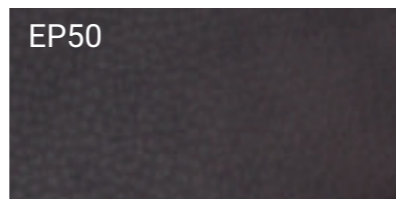
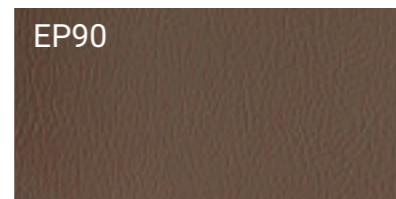
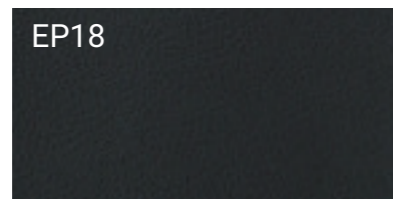
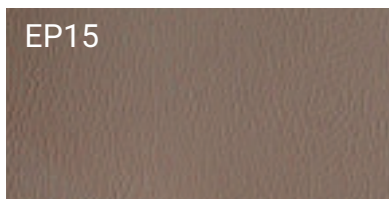

EP15  
CREMA CAFFÉ  
COFFEE CREAM

EP18  
GRAFITE  
GRAPHITE

EP90  
FANGO

EP50  
NABUK GRIGIO  
GREY NABUK

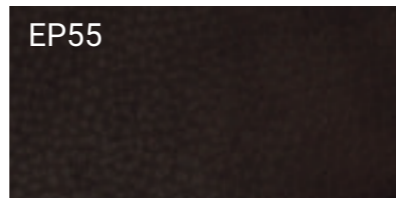
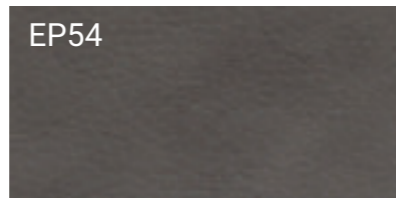
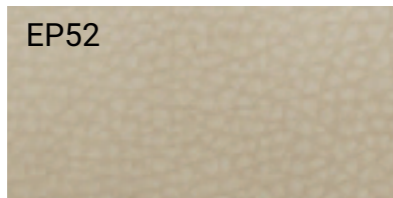
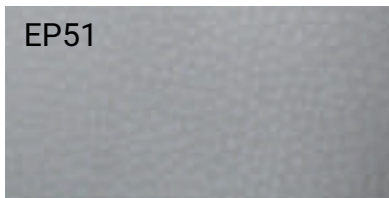

EP51  
NABUK BIANCO  
WHITE NABUK

EP52  
NABUK CREMA CAFFÉ  
COFFEE CREAM NABUK

EP54  
NABUK GHIACCIO

EP55  
NABUK MOKA

POZZOLI GROUP srl licenziataria del marchio OZZIO ITALIA si riserva il diritto di apportare, senza preavviso, ogni modifica volta al miglioramento funzionale e qualitativo dei prodotti. Le informazioni e i disegni rappresentati in questo catalogo, oltre ad avere carattere puramente illustrativo sono suscettibili di variazioni. I campioni di colori e materiali presentati in questo stampato hanno un valore indicativo compatibilmente con i limiti di riproduzione e stampa.

© PROPRIETÀ DI POZZOLI GROUP srl - TUTTI I DIRITTI RISERVATI - I marchi e gli altri segni distintivi, i testi, le fotografie, i disegni ed i modelli, i prodotti e gli altri materiali riportati nella presente brochure e tutti i diritti di proprietà intellettuale ed industriale ad essi relativi costituiscono proprietà riservata di POZZOLI GROUP srl. È vietata la loro riproduzione, copia, imitazione, pubblicazione, diffusione, distribuzione, elaborazione e qualsiasi uso, anche parziale, nella pubblicità, sui prodotti, confezioni, materiali illustrativi o pubblicitari, siti internet, nelle attività di marketing e commerciali ed ogni altro uso, senza la preventiva autorizzazione scritta di POZZOLI GROUP srl.

OZZIO ITALIA brand of POZZOLI GROUP srl reserves the right to change, without notice, any modification to the improvement functional and quality of the products. The information and drawings in this catalog, as well as have purely illustrative are subject to change. Samples of colors and materials presented in this publication are indicative consistent with the limitations of reproduction and printing.

© PROPERTIES OF POZZOLI GROUP srl - ALL RIGHTS RESERVED - Trademarks and other distinctive signs, texts, photographs, drawings and models, products and other materials contained in this brochure and all the intellectual and industrial property rights relating thereto are copyrighted by POZZOLI GROUP srl. And 'forbidden their reproduction, copying, imitation, publication, dissemination, distribution, processing and use, even partial, advertising, products, packaging, artworks or advertising, websites, marketing activities and sales and all other use without the prior written permission of POZZOLI GROUP srl.



CONCEPT & A.D. ARCH. LARA SANTIN

IMAGES NEROKUBO

STAMPA GRAFICHE ANTIGA





MOVE YOUR SPACE

**POZZOLI GROUP srl**

Via Brughetti 17

Bovisio Masciago 20813 - MB - Italy

T +39 0362 59701

[www.ozzio.com](http://www.ozzio.com)