

Doors

Systems

lualdi

Doors

Systems

Sliding Systems & Pivot Glass Door
Partitions & Boiserie
Rasomuro 55 System
Architectural Collection
Home Collection

05	L16
08	<i>Sliding Systems & Pivot Glass Door</i>
10	Shoin
26	Shoin Pivot
36	Koan
46	L7
56	L7 Plus
62	Sliding 50
72	<i>Partitions & Boiserie</i>
74	Wall&Door
88	Boiserie
96	Avenue Boiserie
104	Edge Boiserie
110	<i>Rasomuro 55 System</i>
112	Rasomuro 55s
126	Rasovetro 55s
132	Rasoline 55s
138	Rasotouch 55s
144	Edge
150	Raso USA
156	Compass 55
174	Sliding Pocket
180	<i>Architectural Collection</i>
182	L7
192	L7 Scorrevole a scomparsa
198	L7 Large
210	L41
216	L41 Scorrevole a scomparsa
220	Super
226	Outline
232	Drive
238	<i>Home Collection</i>
240	Filo 55 s-t
250	Lcd62
258	Avenue
266	San Siro
272	<i>Technical drawings</i>
304	<i>Handles</i>
308	<i>Finishes</i>



XXIII ADI
COMPASSO D'ORO
INTERNATIONAL
AWARD

L16

Progettata da Piero Lissoni, L16 è pensata per riduzione. Di spessori, innanzi tutto. Straordinariamente sottile, l'anta battente somiglia a un foglio, una pagina nitida, capace di separare gli ambienti con mano leggera e movimento fluido. Ogni elemento visibile è progettato per scomparire. Quel che si offre allo sguardo è una superficie intatta, ripulita di ogni segno, perfettamente uniforme, vero e proprio elemento architettonico in grado di caratterizzare e definire lo spazio, grazie al risalto di essenze e colori.

Designed by Piero Lissoni, L16 is studied to enable dimensions to be reduced, especially in thickness. Remarkably thin, the hinged door appears as a sheet, an unblemished page, able to separate spaces with a light touch and fluid motion. Each visible element is designed to disappear. To the eye it offers a flawless surface, free of any imperfection and perfectly uniform; a true architectural element able to characterize and define the space, thanks to the prominence of woods and colors.

Il coprifilo di L16, qui in laccato rosso lucido, può diventare un pannello ed estendersi intorno alla porta con un effetto boiserie di grande impatto decorativo.

The profile of the L16, here in red gloss lacquer, can become a panel and extend out from around the door providing a boiserie effect of great decorative impact.



Sliding Systems & Pivot Glass Door

[08 - 71]

I sistemi sono un progetto fluido e flessibile per suddividere gli spazi con superfici in vetro o legno, pannelli e porte scorrevoli che si integrano con armonia con l'architettura e l'arredo. Per ottenere leggerezza visiva e soluzioni di continuità negli ambienti interni.

These systems are a fluid and flexible project to divide spaces with glass or wood surfaces, sliding panels and doors that integrate harmoniously with the architecture and furnishings. To obtain visual lightness and continuity in indoor environments.

Shoin

Ispirata alle ampie e leggere superfici mobili della casa tradizionale giapponese, Shoin è un sistema ad uno o due binari, di pannelli scorrevoli, fissi e pivotanti, in vetro. Le lastre vivono all'interno di un sottile telaio in alluminio, a filo con il vetro sulla facciata esterna della composizione.

Inspired by the light and extensive mobile surfaces of the traditional Japanese house, Shoin is a system of one or two track, glass sliding or pivoting doors and fixed panels, designed to create walls. The panels are fixed within a slim aluminium frame, flush with the external side of the composition.





Shoin, composizione a due ante scorrevoli con telaio in alluminio bianco e vetro trasparente riflettente.

Shoin, a composition with two sliding doors, white aluminium frame and transparent reflective glass.





Parete divisoria realizzata con elementi scorrevoli e fissi Shoin in vetro Flutes grigio trasparente, profilo bronzo.

Partition wall composed of Shoin sliding and fixed elements in Flutes grey transparent glass, bronze profile.

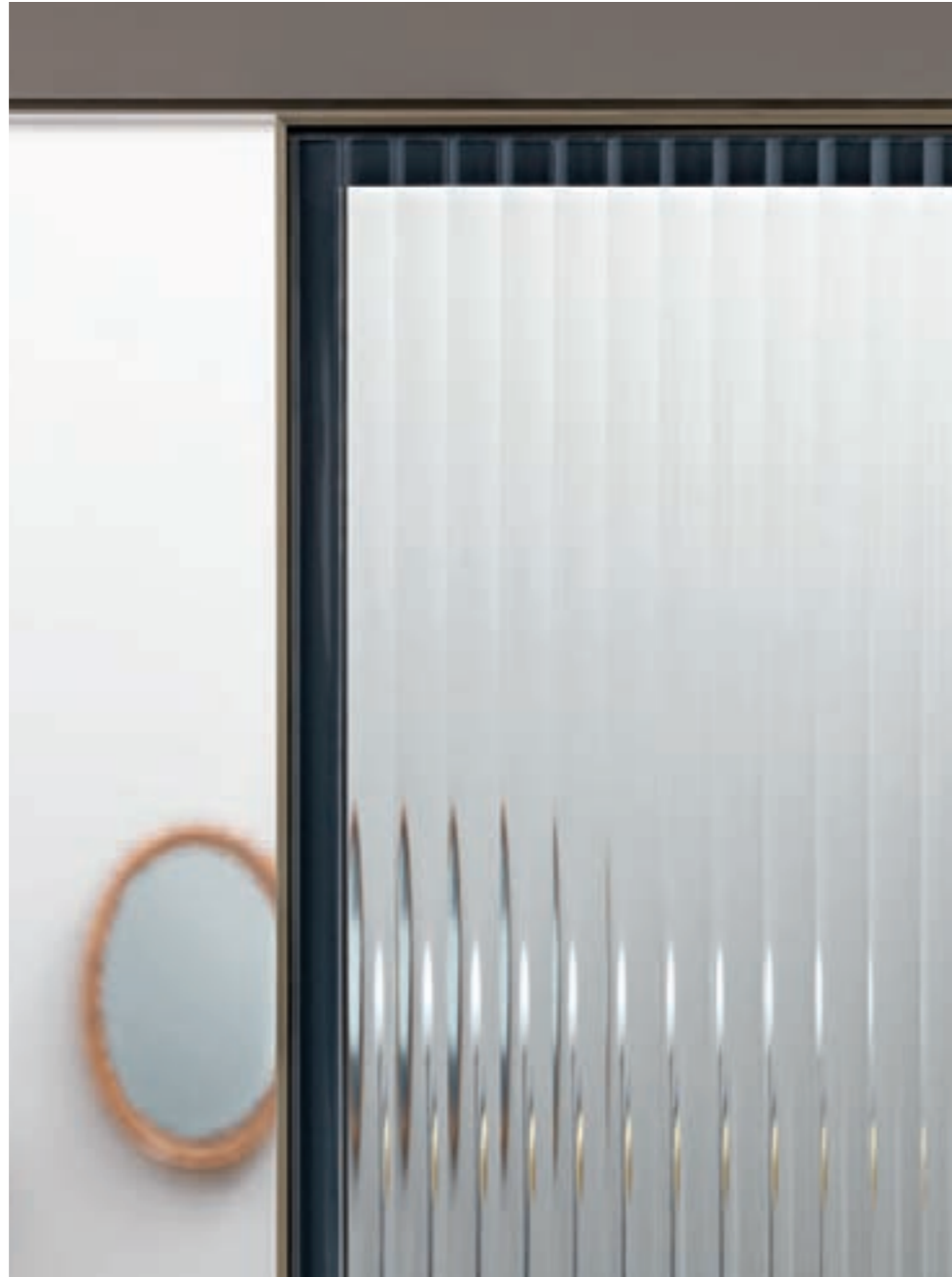



Shoin, composizione a due ante fisse e due mobili. Il telaio in finitura bronzo è combinato con vetro Flutes grigio trasparente. La maniglia a incasso è inserita nel vetro.

Shoin, composition with two fixed and two sliding doors. The frame in a bronze finish is combined with Flutes grey transparent glass. The recessed handle is inserted directly into the glass.







La riuscita estetica di Shoin, anche nei sistemi più complessi e articolati, è il risultato di soluzioni funzionali.

Highly technological and functional solutions, even in the most complex system, are the key to the aesthetic success of Shoin.





Shoin Pivot

La porta a bilico Shoin è caratterizzata dall'essenzialità formale dei suoi elementi tecnici.

The Shoin pivoting door is characterized by the formal simplicity of its technical elements.

Shoin pivotante con finitura in vetro Masterpoint, profilo nero.
Pivoting Shoin in Masterpoint glass, black profile.





La presenza leggera di Shoin Pivot crea ambienti nitidi e accoglienti, scatole luminose attraversate dalla luce.

The light presence of Shoin Pivot creates well-defined and welcoming environments, luminous boxes traversed by light.

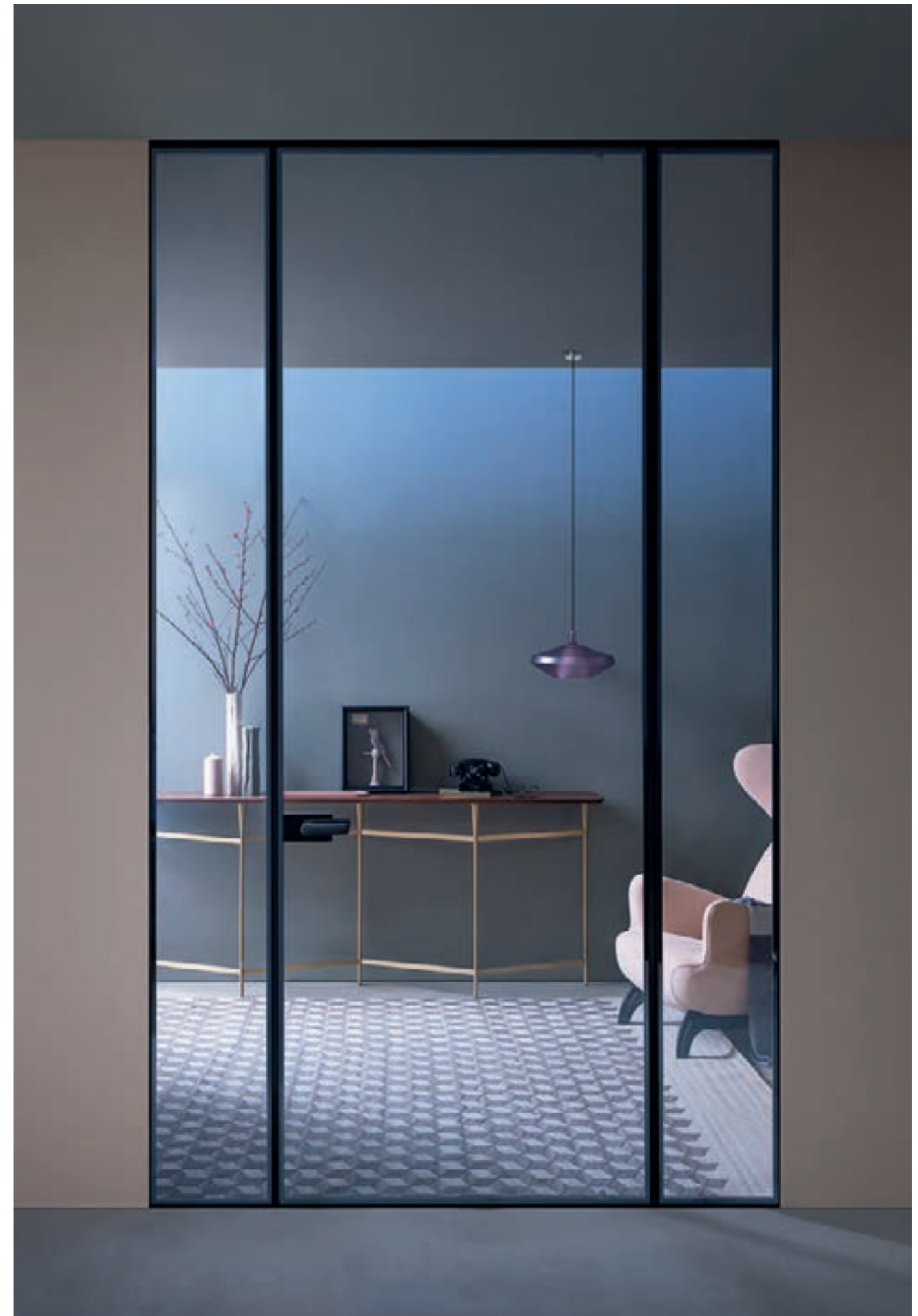



Inserita tra due pannelli fissi laterali, Shoin pivotante ha il vetro extrachiaro riflettente e il profilo in alluminio nero opaco.

Inserted between two fixed side panels, the pivoting Shoin has reflective extra-clear glass and a profile in matt black aluminum.

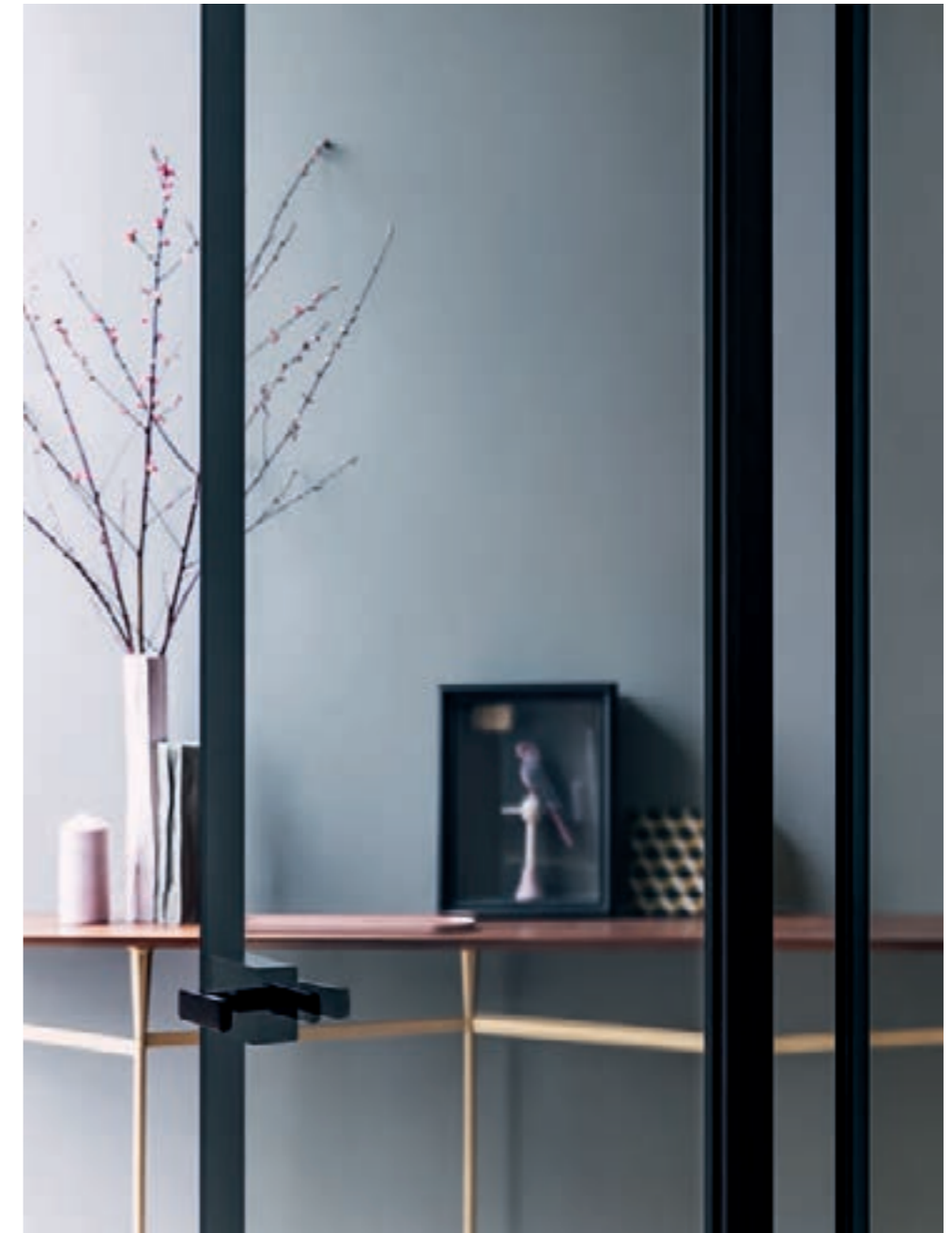

Koan

Unendo la luce di vetro e alluminio al calore del legno, Koan progettata da Kokai Studio, rappresenta la perfetta coesione tra tecnologia e tradizione. La combinazione di listelli verticali, che si alternano su lunghezze variabili, sottolinea il valore prezioso del pannello vetrato in grado di offrire un ritaglio scenografico dello spazio oltre la porta.

Koan, designed by Kokai Studio, combines the radiance of glass and metal finishes with the warmth of wood, creating a perfect cohesion of technology and tradition. The combination of vertical slats highlights the beauty of the glazed panel, offering a scenographic view of the space beyond the door.



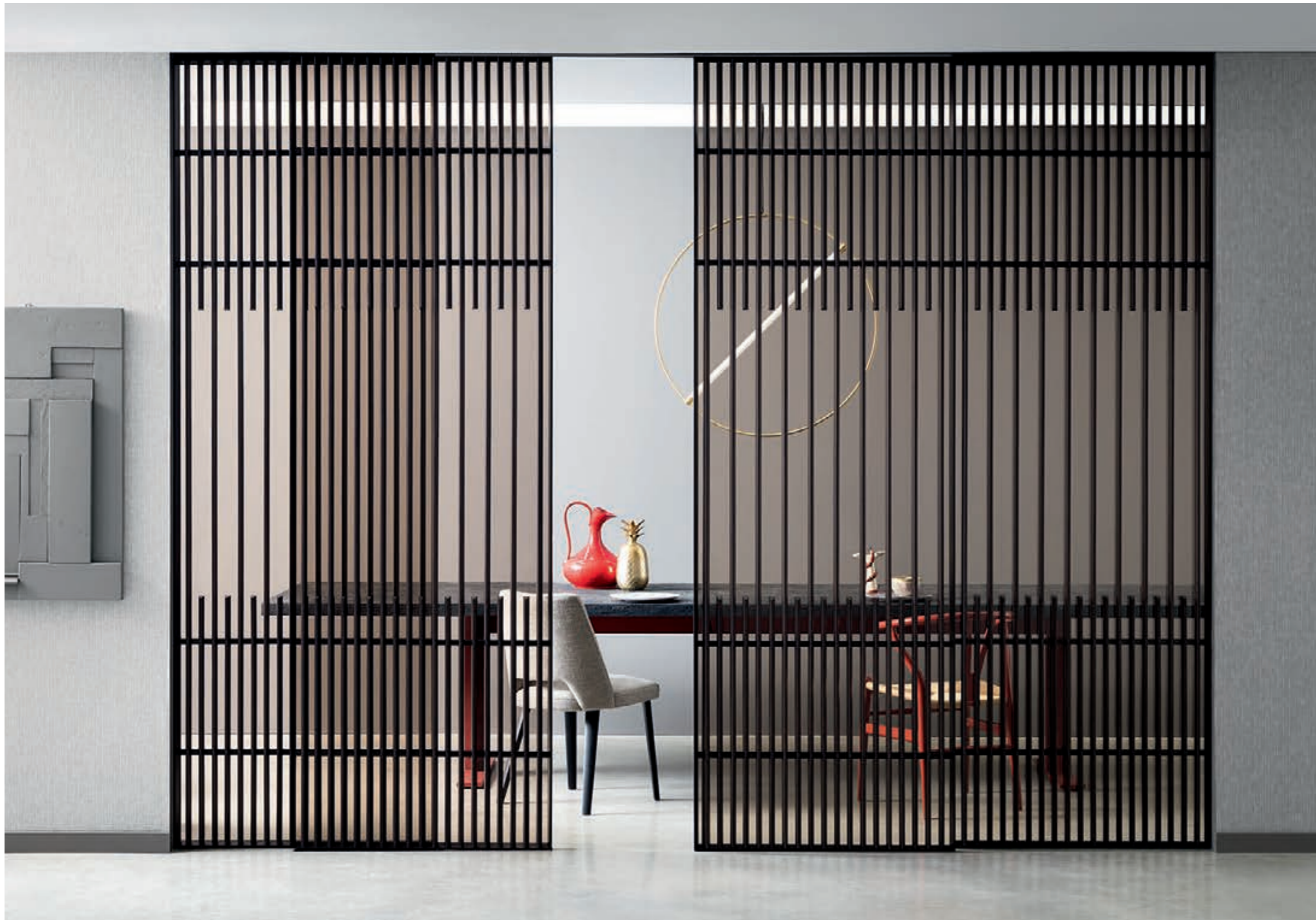



Riflessi caldi per questa composizione a due ante scorrevoli, con listelli in rovere sabbia, profilo bronzo e vetro grigio trasparente.

Warm reflections for the composition with two sliding doors, sand oak slats, bronze profile and transparent grey glass.



Riprendendo il leitmotiv dei listelli, la maniglia diviene un elemento verticale decorativo per un effetto di grande impatto visivo.

Taking up the leitmotiv of slats, the handle becomes a decorative vertical element to great visual effect.



L7

La leggerezza dell'alluminio, la luminosità del vetro, il design di Piero Lissoni, il background di Lualdi. Nasce L7, una porta contemporanea per concezione, uso di materiale e tecnologie, ma classica per estetica. In versione scorrevole, L7 crea soluzioni perfette, tagliate su misura, per definire spazi domestici e di lavoro. Scandite dalle linee lucenti dei telai, le superfici vetrate sono accese dalla bellezza dei riflessi e delle sfumature di colore.

The lightness of aluminium, the luminosity of glass, the design of Piero Lissoni, the background of Lualdi. The L7 door is contemporary in its conception and use of materials and technologies, but at the same time classic in appearance. The sliding version of L7 creates perfect solutions, tailored to define both domestic and work spaces. Punctuated by the lustrous lines of the frames, the glass surfaces are illuminated by beautiful hues and shades of colour.

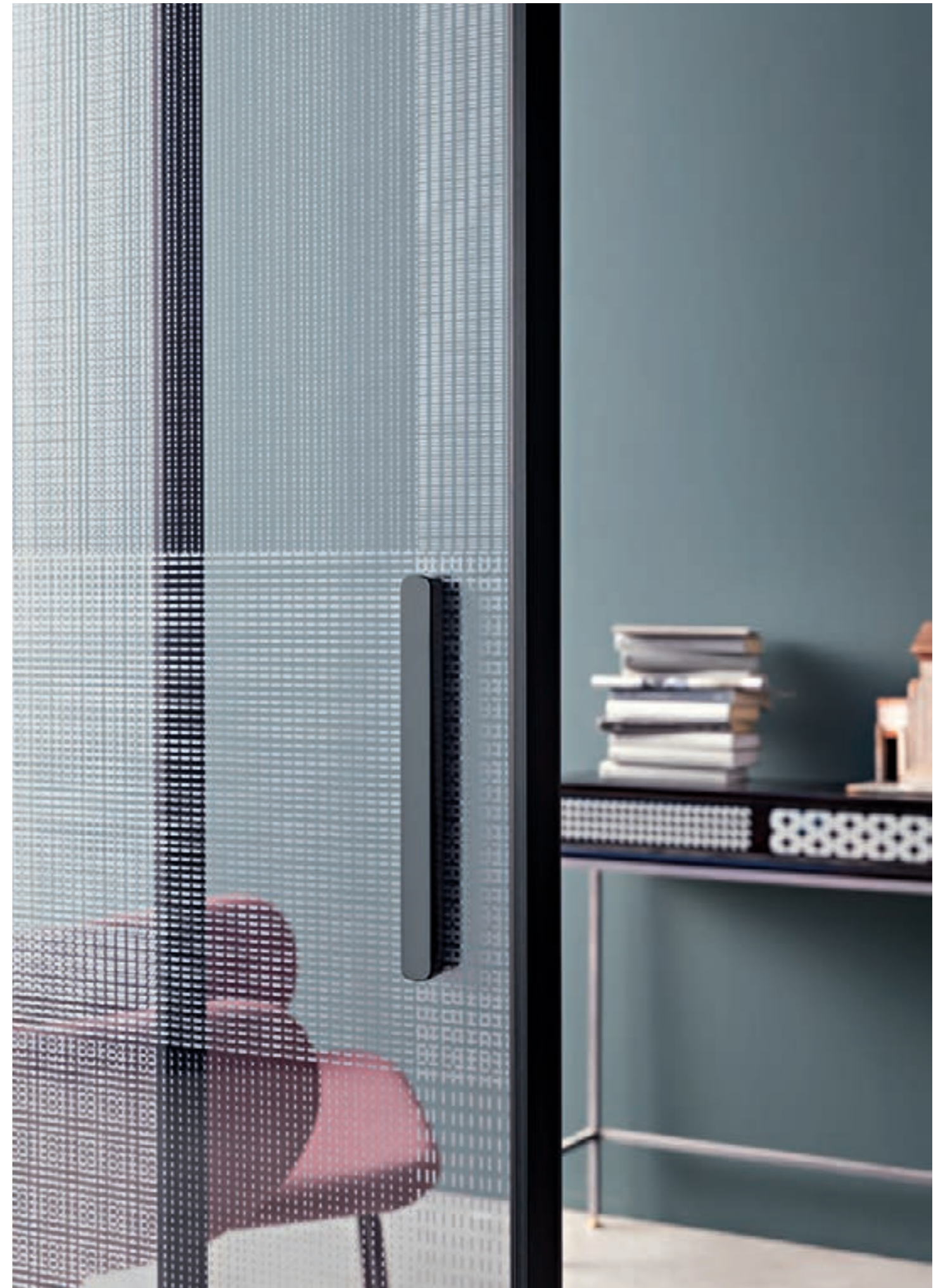



L7 scorrevole con vetro Marks extrachiaro e profilo nero opaco: gli impalpabili decori, sovrappo-
nendosi, creano nuove, raffinate
grafiche.

The sliding L7 with Marks extra-
clear glass and a matt black profile:
the impalpable and overlapping
patterns create new, sophisticated
graphic elements.





L7 scorrevole: una presenza funzionale che diventa elemento spaziale sottilmente decorativo.

L7 sliding version: a functional presence that becomes a subtly decorative spatial element.





L7 Plus, parete divisoria con elementi scorrevoli in vetro grigio trasparente, telaio e listelli neri.

L7 Plus, partition wall with sliding elements in grey transparent glass, black frame and trim.

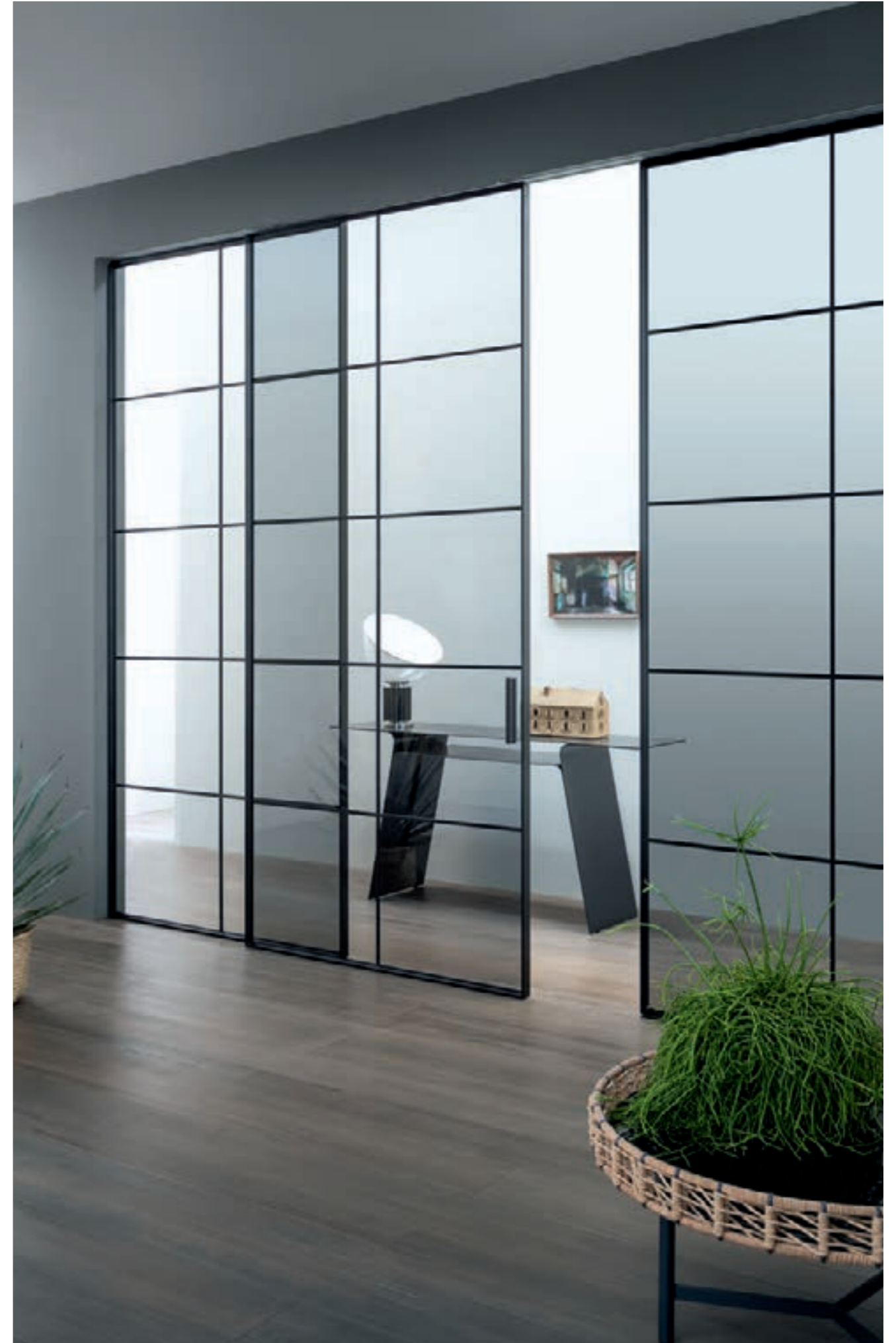

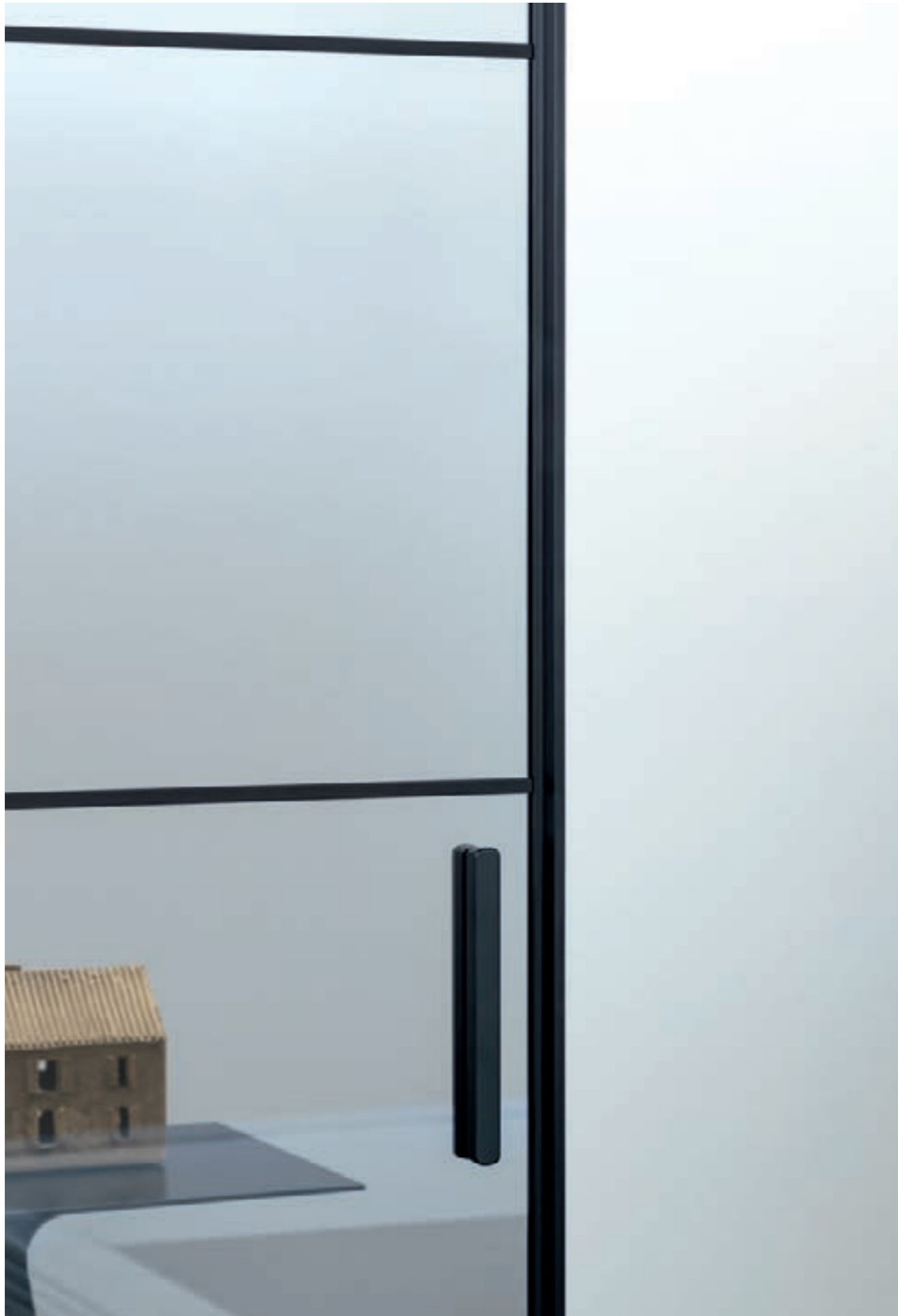

La purezza formale del disegno grafico del telaio e dei listelli di colore nero abbinati al vetro grigio trasparente.

The formal purity of the black frame and trim paired with grey transparent glass.

Sliding 50

Duttile e versatile, il sistema di partizioni divisorie Sliding 50 è realizzato con pannelli scorrevoli di spessore 50 mm. Configurabile in molteplici versioni in essenza o laccato, si integra con estrema flessibilità nei diversi contesti architettonici.

The Sliding 50 partition system is both ductile and versatile and formed of 50 mm thick sliding panels. Configurable in a range of versions, both veneered and lacquered, it integrates with extreme flexibility in different architectural contexts.

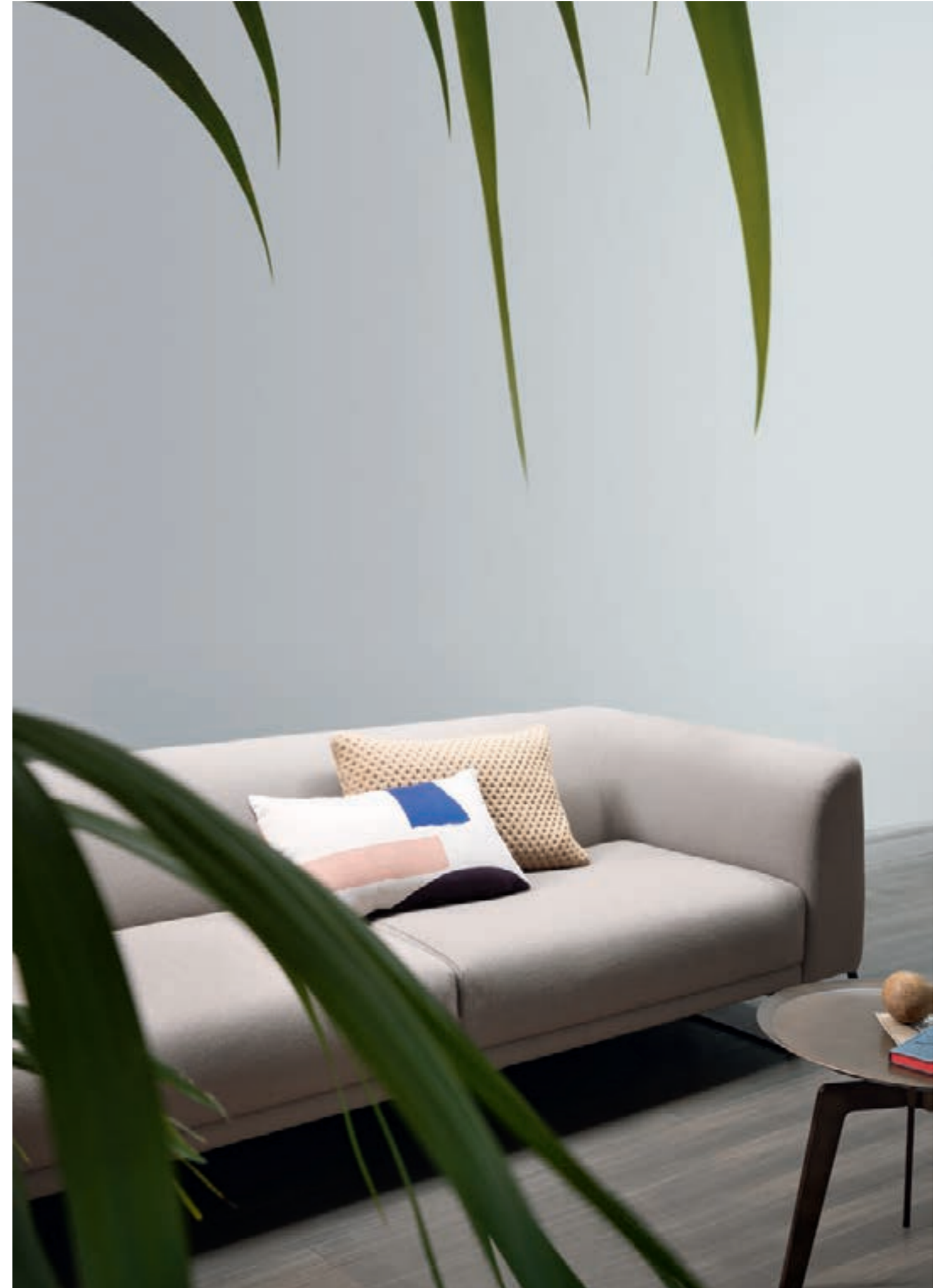





La grande anta scorrevole in rovere precomposto è una presenza amichevole, una zona di luce naturale e silenziosa.

The large sliding door in oak veneer is a friendly presence, an area of natural light and silence.



Una bellezza materica e naturale per l'anta scorrevole in finitura Matrix, sottolineata dall'armonia della pannellatura liscia in noce canaletto.

A materic and natural beauty for the sliding panel in Matrix finish, accentuated by the harmony of the wall cladding in Canaletto walnut.



Partitions & Boiserie

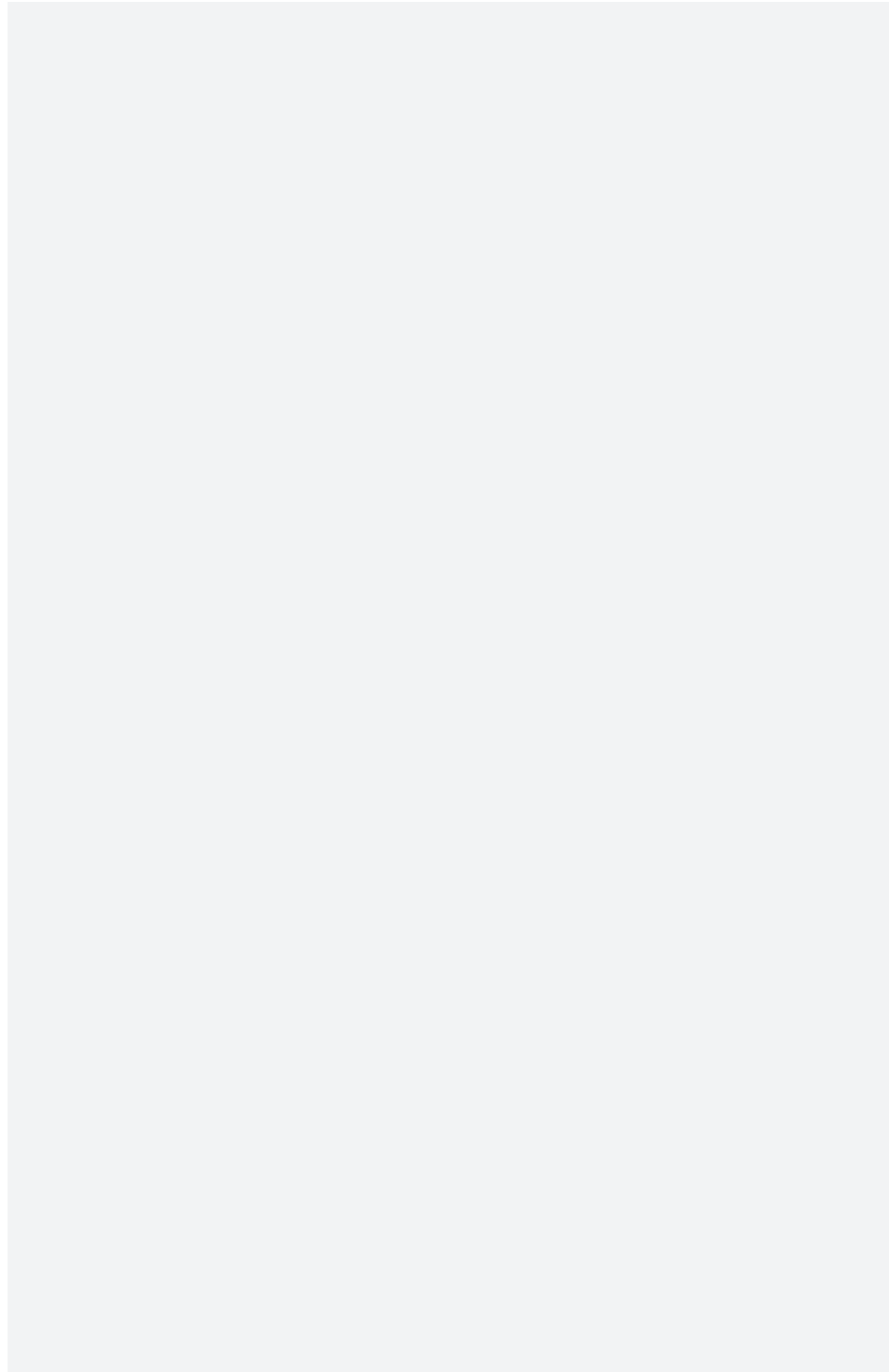

Nobili soluzioni decorative, il sistema di pannelli modulari Wall&Door e la boiserie di antica tradizione storica interpretati in termini contemporanei sono elementi architettonici scenografici capaci con le loro superfici omogenee di dare identità e calore agli ambienti.

Gracious decorative solutions, the modular system of Wall&Door panels and the boiserie of ancient historical tradition interpreted in contemporary terms are spectacular architectural elements capable of conferring identity and adding warmth to settings with their homogeneous surfaces.

Wall&Door

Wall&Door è un sistema che assembla pannelli modulari, ante e porte, pensato come soluzione per razionalizzare, definire e rendere più omogenee le superfici di uno stesso ambiente.

Wall&Door is a system composed of modular panels and doors, created to rationalize, define and harmonize the surfaces of a room.





Composizione parete Wall&Door
in noce canaletto e tappezzeria.
Wall&Door wall composition
in canaletto walnut and upholstery.





La soluzione del bordo in alluminio bronzo è utilizzata quando i due lati della porta sono in finitura diversa.

The solution with a bronze aluminium edging is used when the two sides of the door have a different finish.







La finitura in rovere sbiancato
è una presenza calda e avvolgente.

The white oak finish is a warm
and enveloping presence.

Boiserie

Riedizione moderna della tradizione storica, le estese superfici di rivestimento in legno delle boiserie arredano gli interni con eleganza e con uno stile classico, raffinato di gusto contemporaneo, permettendo di realizzare soluzioni progettuali non convenzionali.

A modern re-working of an historical tradition, the large wooden panelled surfaces of the boiserie furnish the interior with elegance and a classic, refined style of contemporary taste, allowing the creation of unconventional design solutions.





La porta è perfettamente
integrata nella boiserie.
Finitura thermowood.

The door is perfectly
integrated into the boiserie.
Thermowood finish.

Doors | Systems





La superficie continua della boiserie con la porta integrata a filo con i pannelli.

The continuous surface of the boiserie with the integrated door flush with the panels.

Avenue Boiserie

Avenue, di Robert A. M. Stern, offre una riedizione del gusto anglosassone per l'eleganza più classica, studiata su moduli dalle dimensioni non convenzionali.

Avenue, by Robert A. M. Stern, presents a new reading of the Anglo-Saxon taste for a more classical elegance, studied around forms of unconventional dimensions.

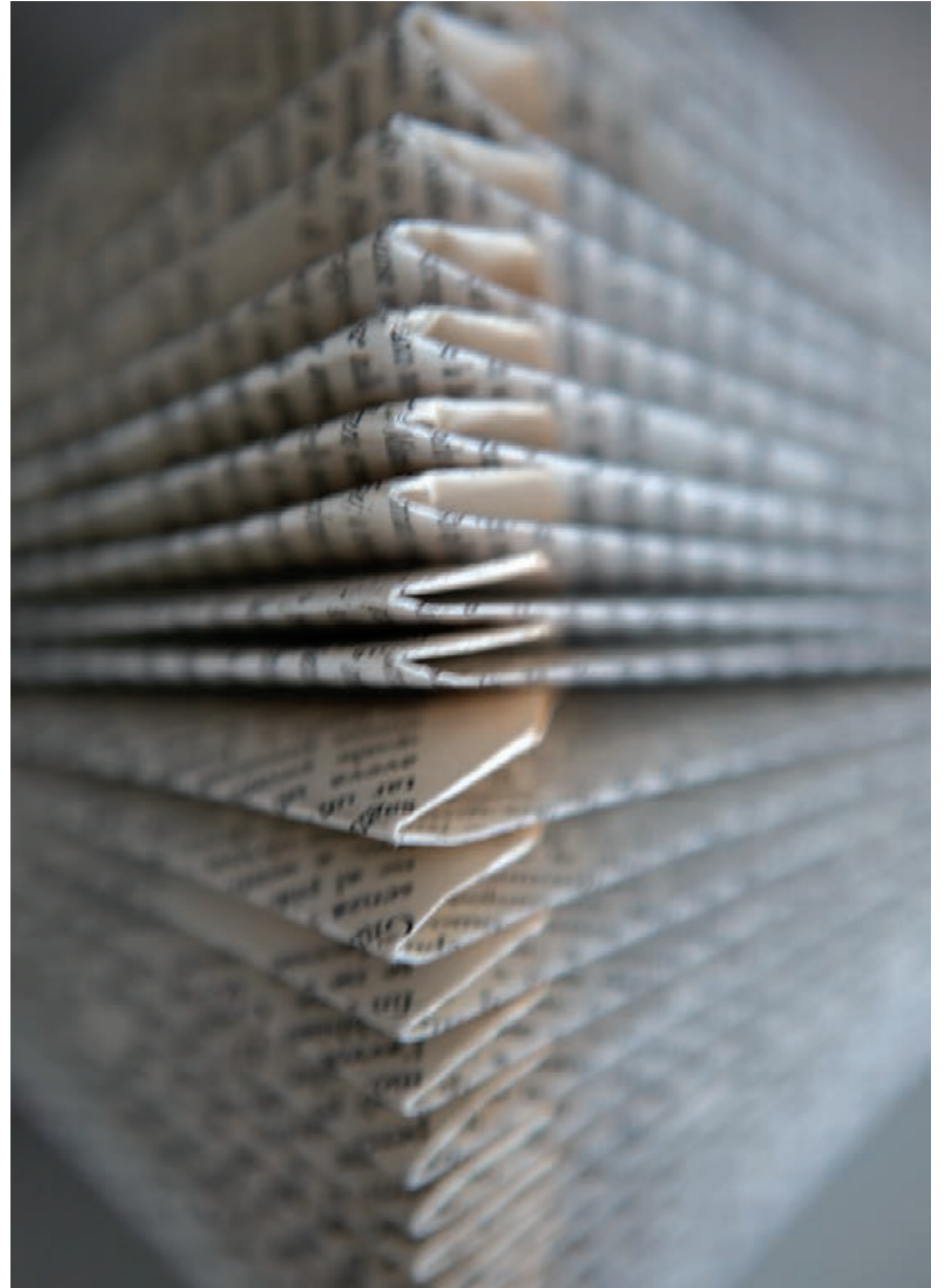



Doors | Systems





Edge Boiserie

Ispirata alla tradizione della boiserie, Edge di Marco Piva interpreta la porta come elemento flessibile e innovativo, capace di espandersi alle superfici circostanti in funzione decorativa e di rivestimento, ma non solo. Sofisticata estensione architettonica, Edge, grazie ai caratteristici tagli del pannello che danno volume a una superficie di solito bidimensionale, è in grado di connotare lo spazio. Il delicato disegno a rilievi e geometrie gioca con luci e ombre, conferendo grazia inedita al passaggio fra ambienti.

Inspired by the tradition of the boiserie, Edge by Marco Piva interprets the door as a flexible and innovative element, able to expand into the surrounding surfaces as decorative cladding. A sophisticated architectural extension, Edge is able to characterize the space thanks to the distinctive cuts of the Panel that lend volume to a normally two-dimensional surface. The delicate and geometric relief pattern plays with light and shadow, bestowing unprecedented grace on the passage between rooms.





Il delicato disegno geometrico a rilievo tridimensionale di Edge gioca con luci e ombre, conferendo dinamicità alla parete.

The delicate and geometric three-dimensional relief pattern of Edge plays with light and shadow, lending vibrancy to the wall.



Rasomuro 55 System

[110 - 179]

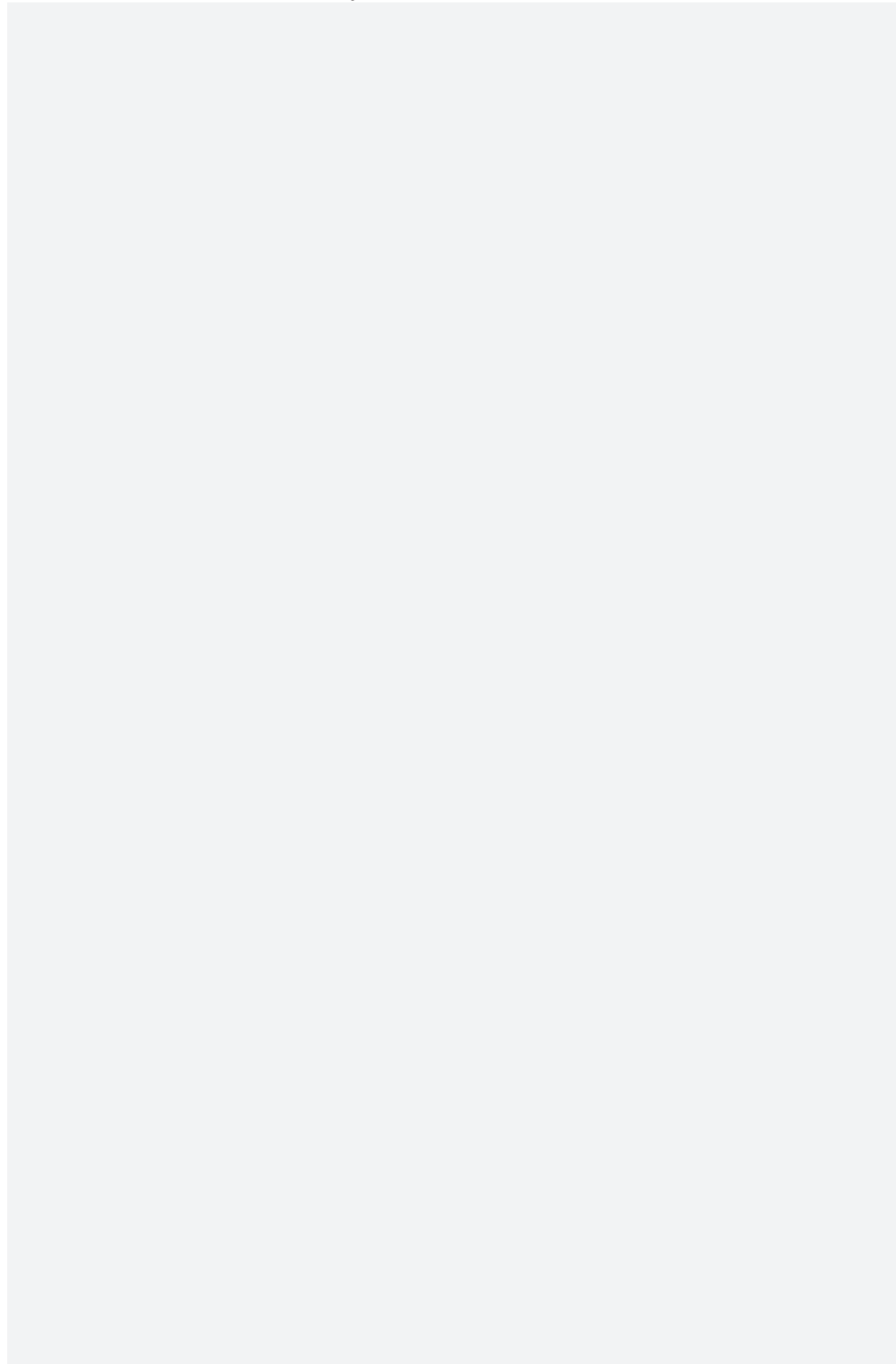

*É la naturale evoluzione del modello storico Rasomuro.
Perfettamente integrata nella struttura architettonica,
la porta “che non c’è” ha le cerniere a totale scomparsa,
lo stipite invisibile in alluminio e la capacità di integrarsi
alla parete con mimetismo perfetto.*

*This is the natural evolution of the celebrated Rasomuro.
Perfectly integrated into the architectural structure,
the door “which isn’t there” features hinges
that are completely hidden, an invisible aluminium
jamb and the ability to integrate with the wall
with perfect mimicry.*

Rasomuro 55s

Elemento architettonico di transito tra un ambiente e l'altro, la porta integrata alla parete ha un grado di essenzialità visiva e concettuale estrema. Il design è quasi immateriale, per l'eleganza della superficie continua senza alcun dettaglio strutturale a vista.

An architectural element of transition from one space to another, the door integrates into the wall and is particularly minimal in look and radical in concept. The design becomes almost ethereal in the elegance of its seamless surfaces that feature no visible structural detail.

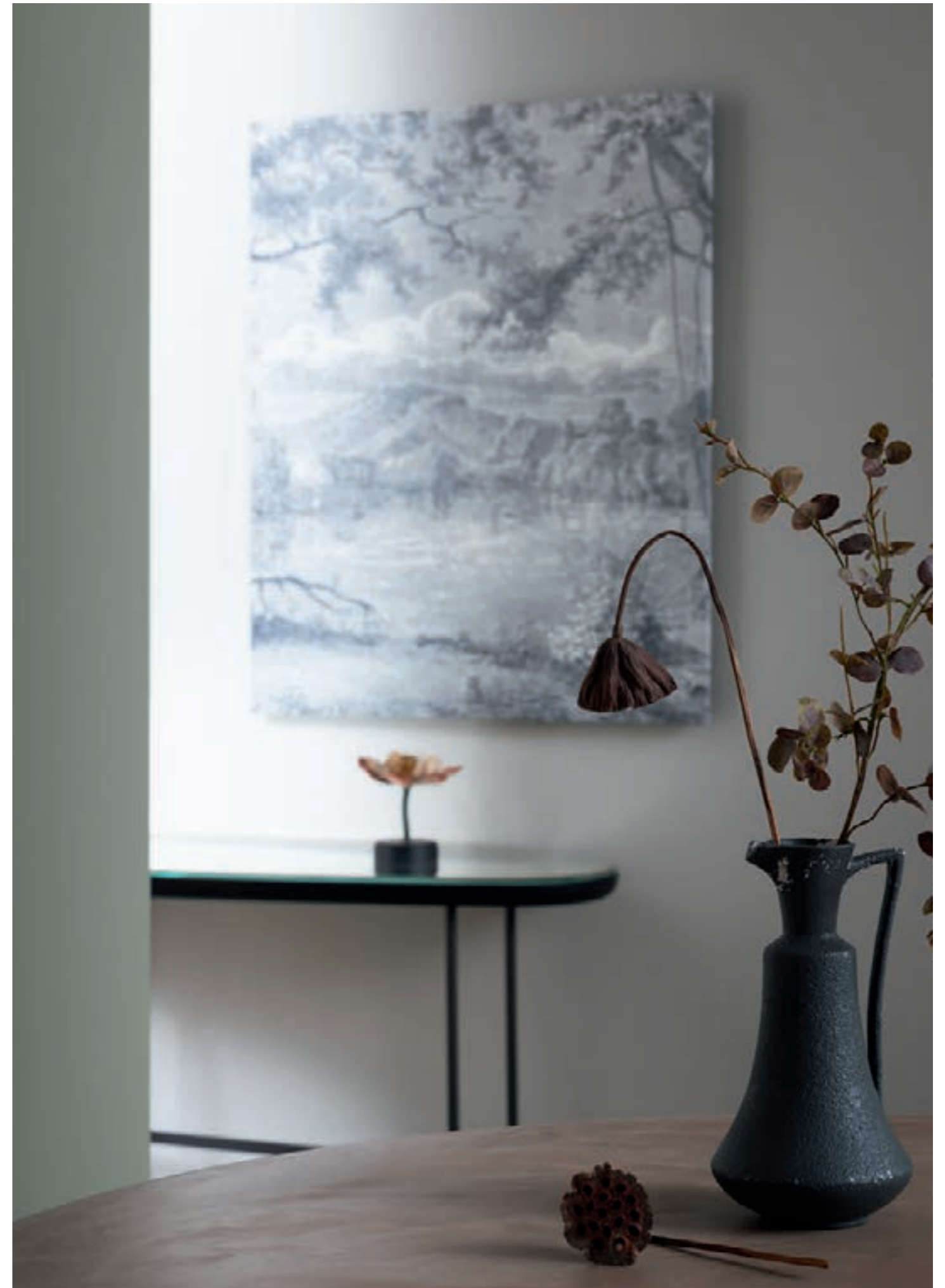



Il disegno grafico creato dalla porta Rasomuro 55s in bianco opaco in combinazione cromatica con la parete di diverso colore.

The delineated design created by the Rasomuro 55s door in matt white establishes a chromatic combination with the wall of a different color.







Grazie alle cerniere completamente a scomparsa, al forte spessore e allo stipite invisibile in alluminio, la porta integrata nella parete si mimetizza nell'ambiente.

Thanks to the completely hidden hinges, the pronounced thickness and the invisible aluminium jamb, the door integrates with the wall and blends into the surrounding environment.



La maniglia, unico segno grafico che delinea la presenza della porta nella superficie continua della parete.

The handle, the only element that indicates the presence of the door in the continuous surface of the wall.

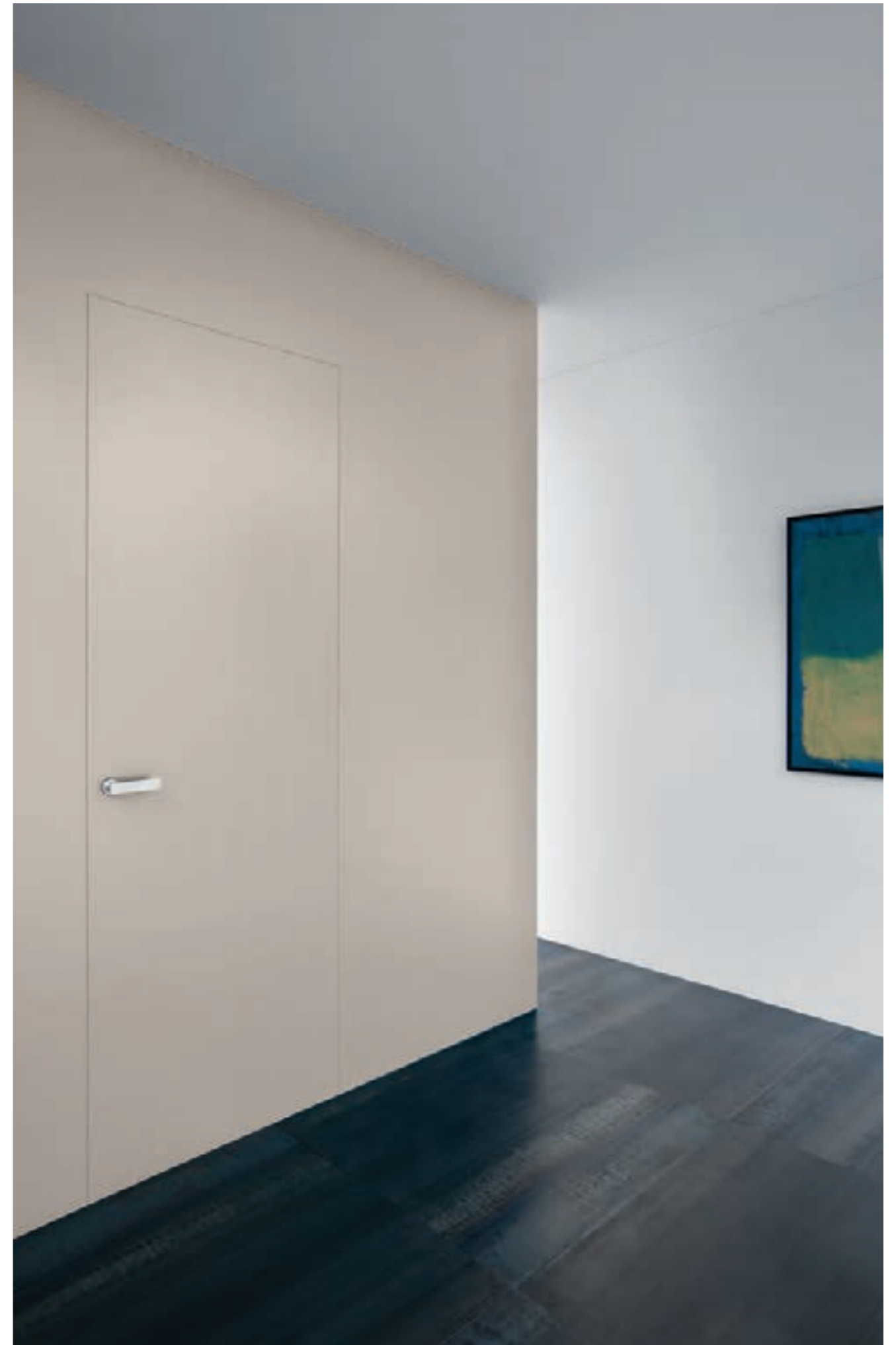



Rasovetro 55s

Rasovetro nasce da Rasomuro e della famiglia ha tutte le caratteristiche, come le cerniere a scomparsa e lo stipite in alluminio.

Esteticamente, invece, sviluppa la propria originalità grazie al vetro, materiale pulito per eccellenza, e alle sue prerogative uniche: trasparenza, luminosità, leggerezza.

Rasovetro derives from Rasomuro and shares all its characteristics, such as the concealed hinges and the aluminium jamb. However, it demonstrates its own aesthetic originality thanks to the glass, the purest of materials, and its unique features of transparency, luminosity and lightness.





Anta in vetro retrolaccato:
una presenza capace di accendere
lo spazio di sofisticati riflessi.

Door in back-painted glass:
capable of illuminating a space
with sophisticated reflections.





Trasparenza, luminosità,
leggerezza estrema sono
le prerogative della porta
nella versione con l'anta
in vetro e profilo di alluminio.

Transparency, brightness
and extreme lightness are
the particular qualities of this
door in the glass version with
aluminium profile.

Rasoline 55s

Perfettamente integrata con la parete e l'architettura circostante, la nuova versione di Rasomuro 55s segna il passaggio da un ambiente all'altro indossando finiture diverse. Due superfici che dialogano con gli spazi circostanti, assecondandone con eleganza le caratteristiche. Le contiene un essenziale bordo metallico in funzione strutturale e decorativa.

Perfectly integrated with the wall and the surrounding architecture, the new version of Rasomuro 55s marks the transition from one room to another with different finishes. Two surfaces that dialogue with the surrounding spaces, complementing their characteristics with elegance. The elemental metal edging, available in various finishes, is both structural and decorative.





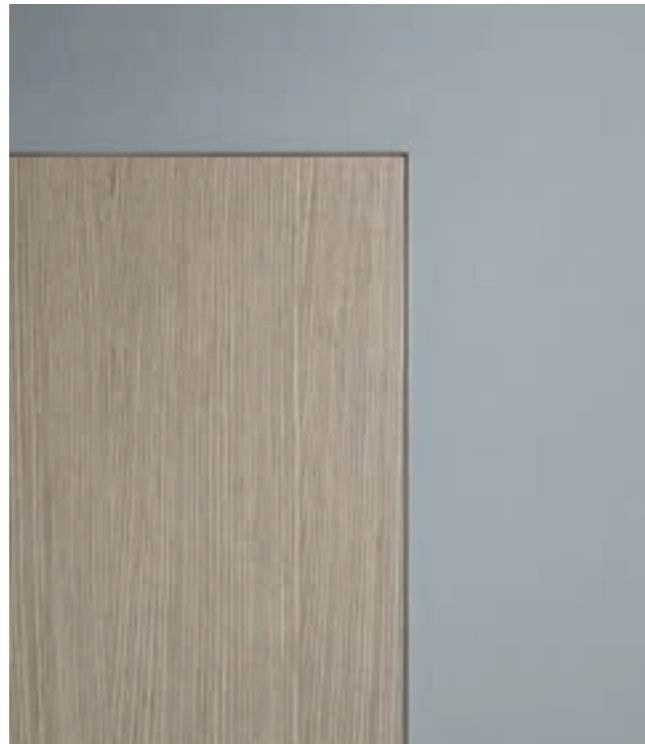

L'anta di Rasoline 55s da un lato è in rovere precomposto, dall'altro grezza verniciata come il muro. Lo stipite e il bordo metallico color bronzo ben si accordano alla qualità cromatica del legno.

One side of the Rasoline 55s door is oak veneered, while the other is left unfinished ready to be painted in the same color as the wall. The bronze colored metal jamb and edging coordinate with the color of the wood.



Rasotouch 55s

Rasotouch è il modello più invisibile della famiglia, creato per scomparire completamente nello spazio circostante. Tocco di perfetta eleganza, la maniglia a scomparsa: un taglio verticale che corre lungo l'anta con la rapidità del più semplice fra i segni: una linea. Design Cairoli & Donzelli

Rasotouch is the most invisible model of the family, specifically created to disappear completely into the surrounding space. The recessed handle is a touch of perfect elegance: a vertical cut runs along the door in the simplest of forms - a straight line. Design Cairoli & Donzelli





Finitura in laccato opaco bianco:
la porta diventa un elemento
architettonico vero e proprio
che concorre a rendere lo spazio
armonico e omogeneo.

Finished in matt white lacquer:
the door becomes a true
architectural element which
contributes to making the space
both uniform and harmonious.



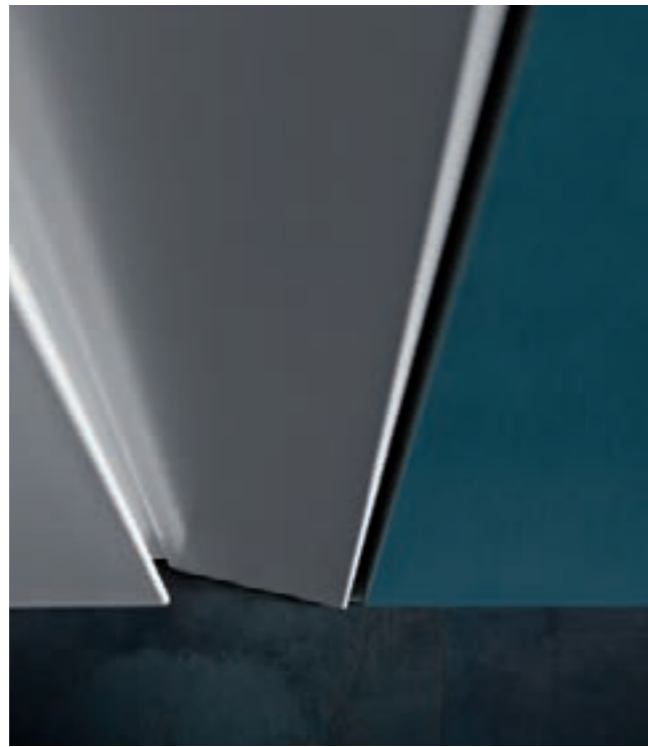

Pratica e funzionale, la maniglia a scomparsa garantisce una presa facile e gradevole.

Practical and efficient, the recessed handle provides an easy and comfortable grip.



Edge

La collezione di porte Edge, disegnata da Marco Piva, nasce dal desiderio di plasmare un oggetto solitamente "piatto", creando un effetto volumetrico mirato a donargli una nuova importanza visiva, senza venir meno alla sua funzionalità. Edge è un incontro di geometrie, volumi e superfici che donano al "passaggio" tra ambienti una nuova enfasi.

Edge is the new collection of doors designed by Marco Piva for Lualdi, born from a desire to give a three-dimensional form to an object that is usually "flat", creating a feeling of volume that confers a new visual significance without affecting functionality. Edge is a meeting of geometries, volumes and surfaces that play on visual perception and transform the door, a "connecting" element between home and office environments, into a new exponent of the living area.

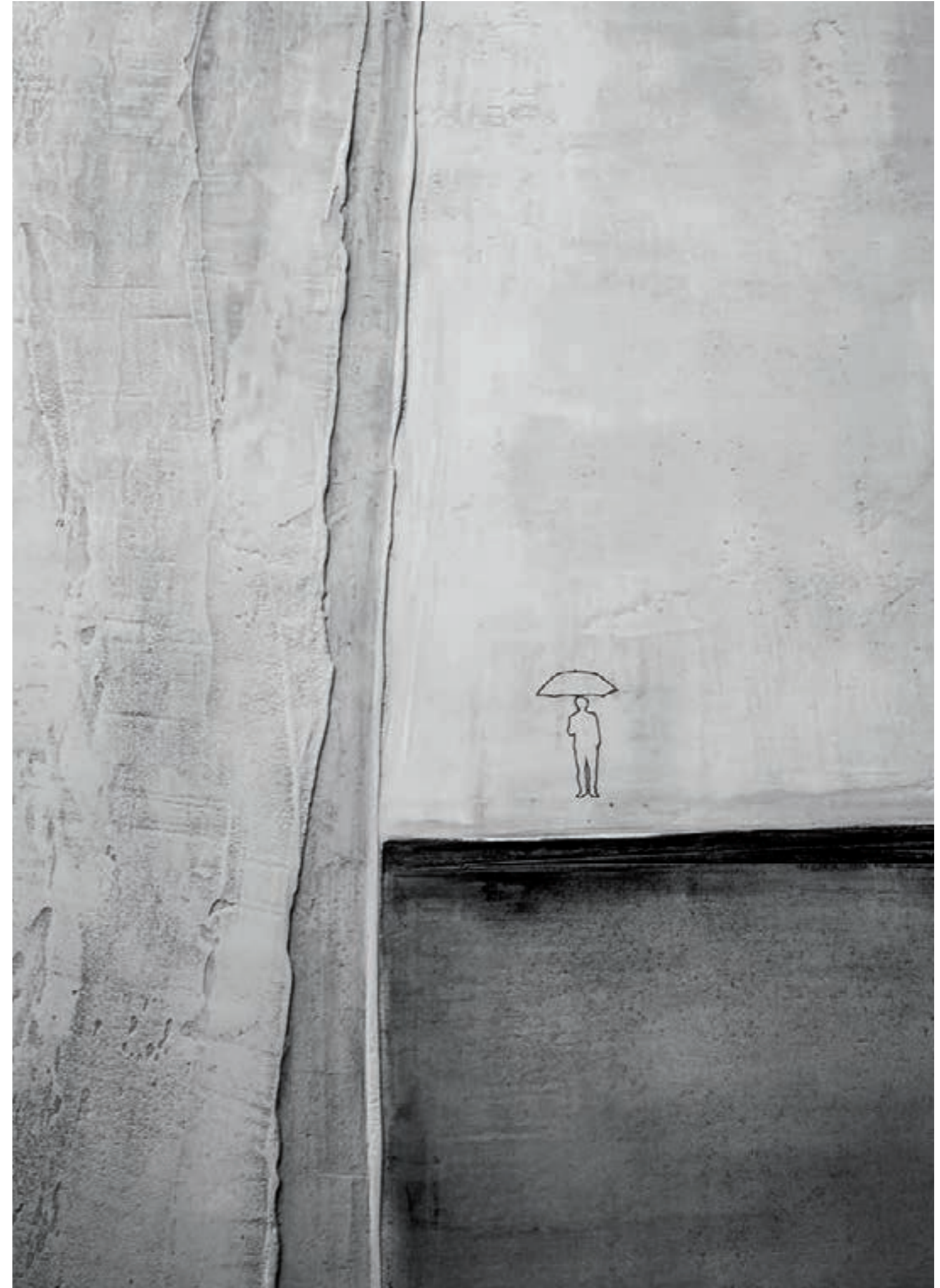

Il taglio simmetrico a 45 gradi sui quattro lati di Edge crea un effetto prospettico elegante e raffinato. Nell'immagine la porta è nella versione laccato opaco bianco gesso.

The symmetrical, 45 degree camber around the four sides of Edge creates a refined and elegant perspective. The picture shows the door in the matt, chalk-white lacquered version.





Dettaglio profilatura del pannello frontale di Edge, un delicato gioco di luci e ombre sulla superficie della porta.

Detail of the profile of the Edge front panel, a subtle play of light and shadow on the surfaces of the door.



Raso USA

A filo parete, con le cerniere a totale scomparsa, il forte spessore e lo stipite a vista, Raso USA ha le stesse caratteristiche tecniche strutturali di Rasomuro 55s, ma ha sempre il profilo di alluminio a vista che diventa elemento grafico e decorativo della porta.

Flush with the wall, with the hinges completely hidden, the pronounced thickness and the visible jamb, Raso USA has the same structural technical characteristics of Rasomuro 55s while maintaining the visible aluminium profile that becomes a defining and decorative element of the door.



Il profilo di alluminio a vista
in versione di colore nero delinea
il perimetro della porta a filo parete
e ne sottolinea la superficie.

The black version of the visible
profile outlines the perimeter of
the door that is flush with the wall
and accentuates the surface.

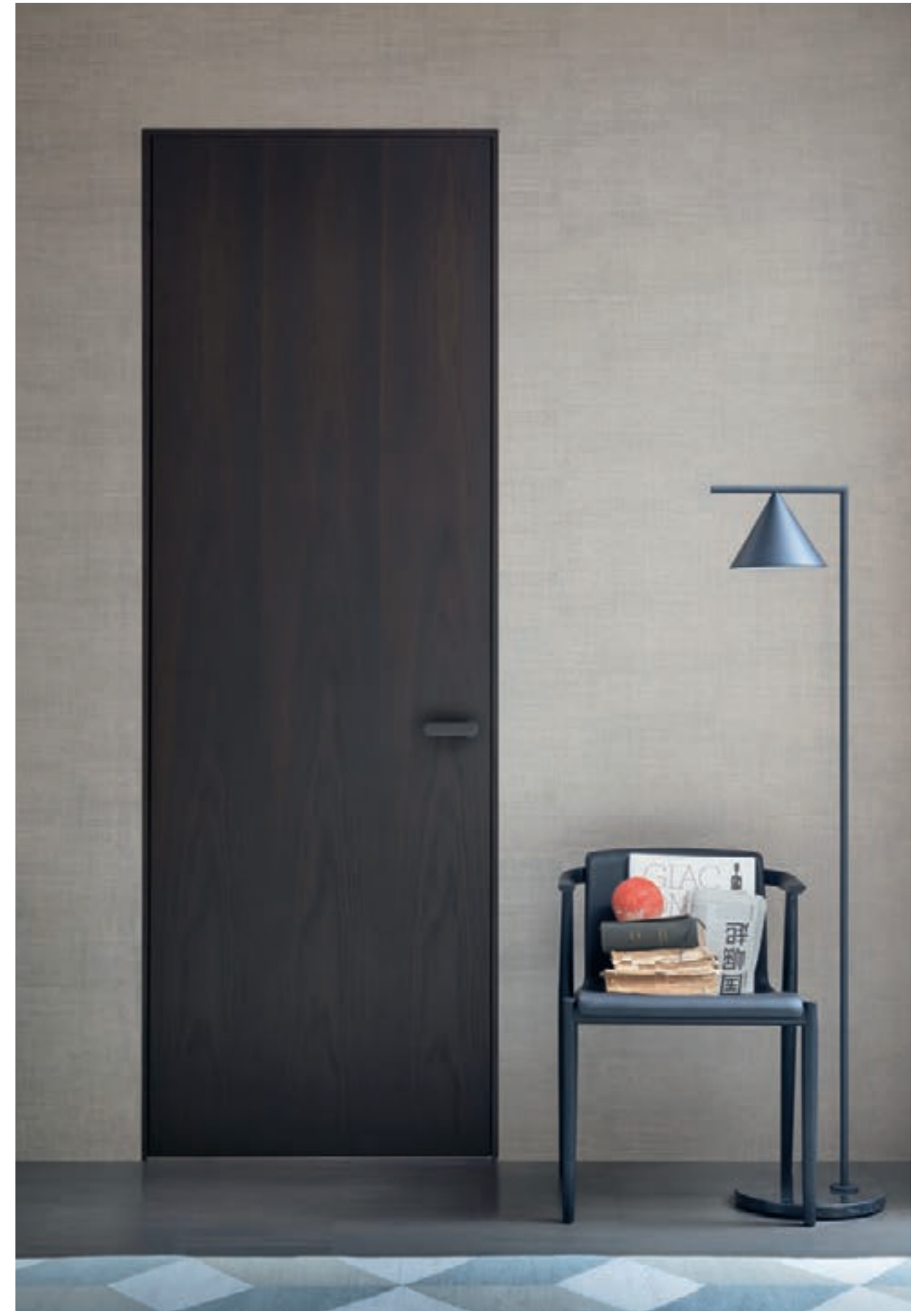



Il profilo a vista della porta
Raso USA in alluminio,
in finitura di colore nero.

The visible profile of the
Raso USA door in aluminium
with a black finish.

Compass 55

Perfettamente allineata, dotata di anta pivotante e autochiusura controllata, Compass 55 ha l'aspetto di una quinta ampia e silenziosa, capace di mettere in comunicazione gli spazi con leggerezza.

Perfectly aligned and equipped with a self-closing pivoting door, Compass 55 can be compared to a large, silent stage curtain, enabling areas to communicate with lightness.

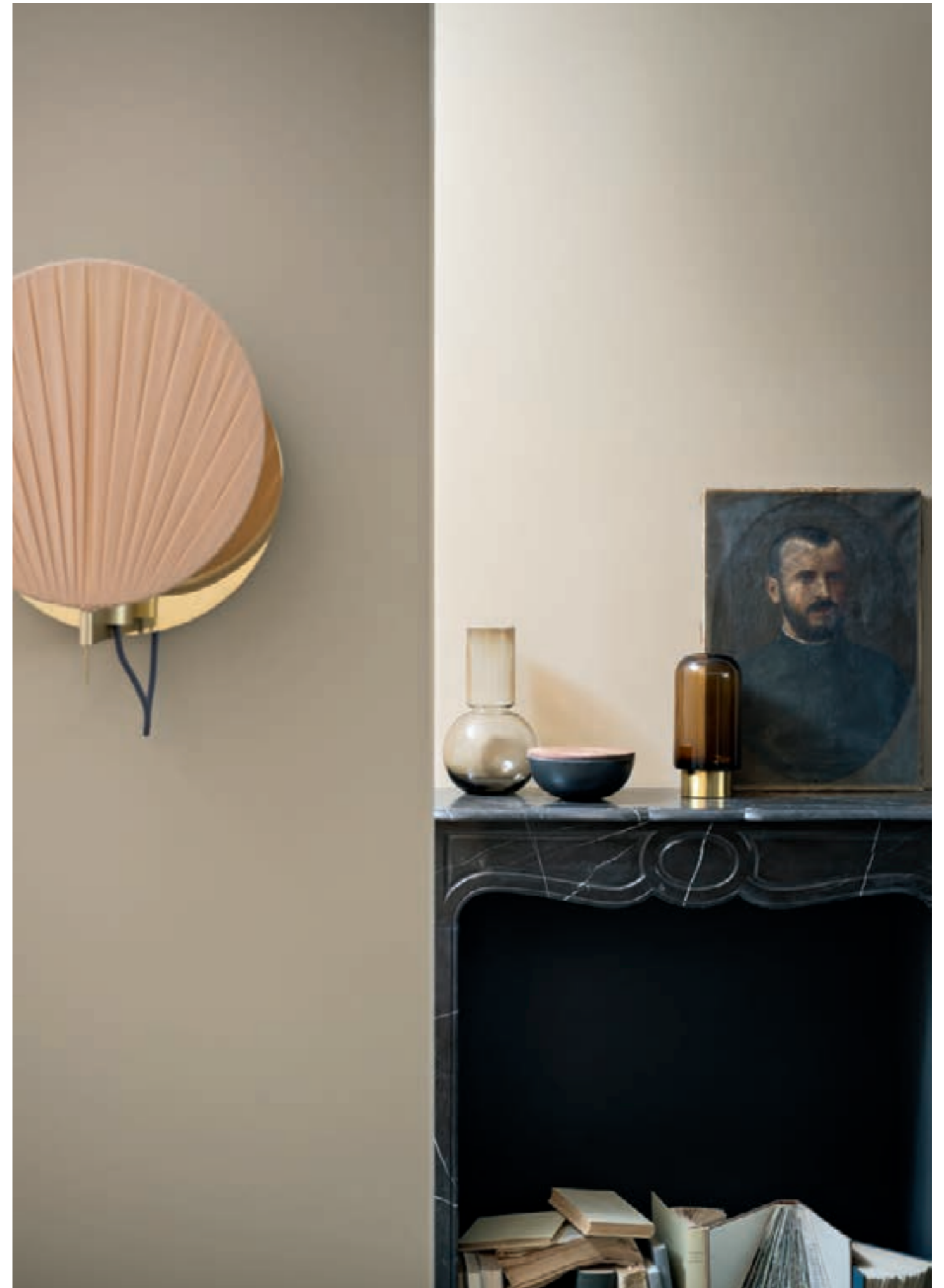





Lo spessore dell'anta pivotante di Compass 55, qui in versione nero fossile, dotata di autochiusura controllata.

The thickness of the pivoting Compass 55 door, here in black fossil version, equipped with controlled self-closing.









L'ampiezza della quinta teatrale pivotante di Compass 55 ne accentua l'aspetto scenico di divisorio spaziale.

The expanse of the pivoting theatrical backdrop of Compass 55 accentuates the scenic aspect of the spatial divider.

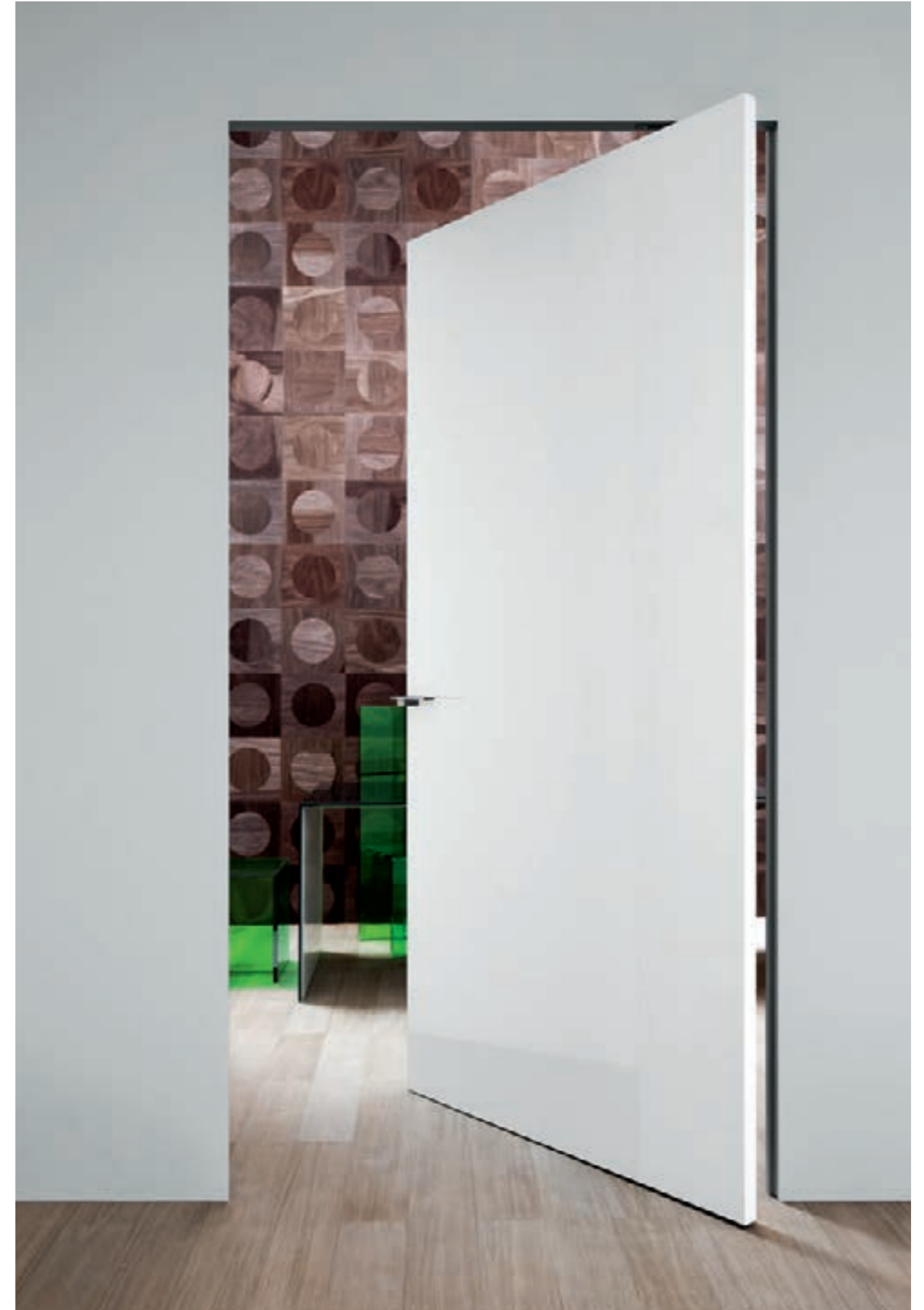

Il calore e la vita del legno vengono resi palpabili dal volume nitido dell'anta pivotante, i cui dettagli scolpiscono delicatamente la parete.

The warmth and life of wood are made palpable by the clear-cut volume of this pivoting door, whose details delicately sculpt the wall.



L'anta pivotante Compass 55 con finitura Matrix creata dall'accostamento di tre intagli diversi e profilo in bronzo.

The pivoting door of the Compass 55 with a Matrix finish created by the combination of three different forms of fretworking and a bronze profile.





I tre diversi pattern grafici della finitura Matrix accentuano la raffinatezza della lavorazione del legno massello.

The three different patterns of the Matrix finish accentuate the refinement of the woodworking.

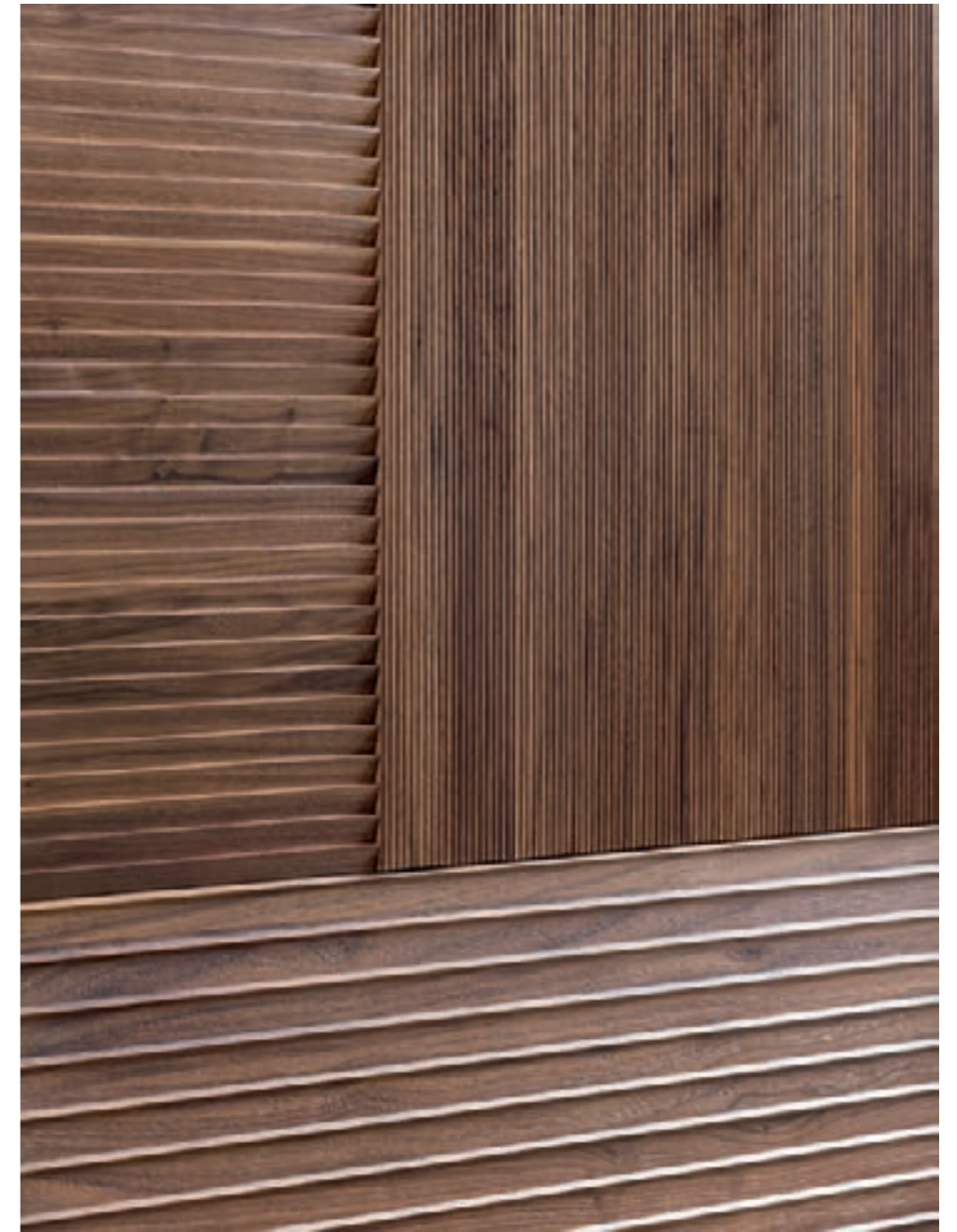

Sliding Pocket

Per uno spazio più fluido, la porta scorrevole interno muro a scomparsa con l'essenziale maniglia a incasso, mette in comunicazione gli ambienti eliminando la presenza visiva dello stipite e l'ingombro dell'anta.

For a more fluid space, the sliding pocket door with the minimalist recessed handle connects the rooms by eliminating the visual presence of the jamb and the encumbrance of the door.

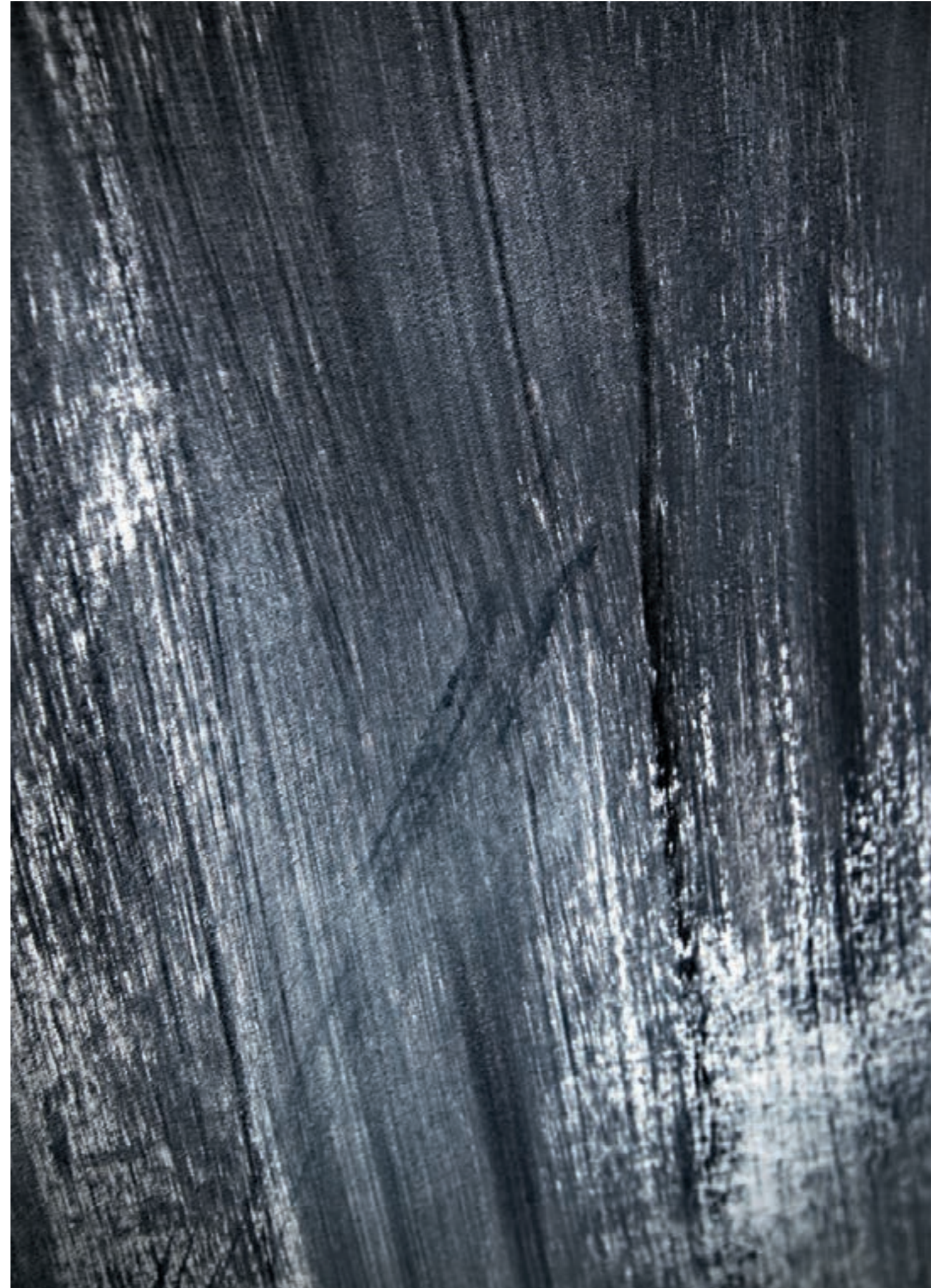

Elegante e raffinata, la porta scorrevole interna in finitura rovere color moka.

Elegant and refined, the sliding pocket door in a mocha-colored oak finish.

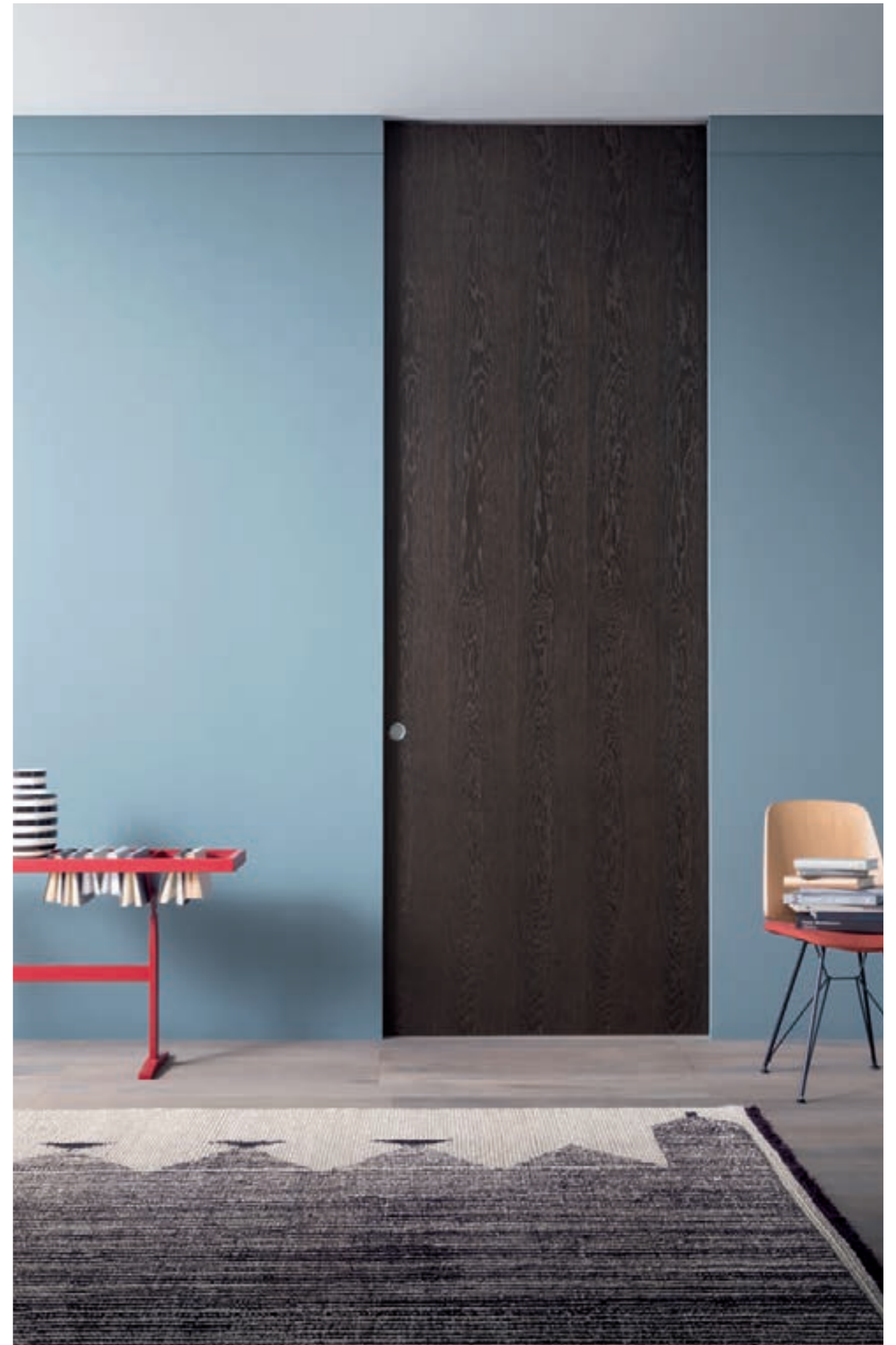

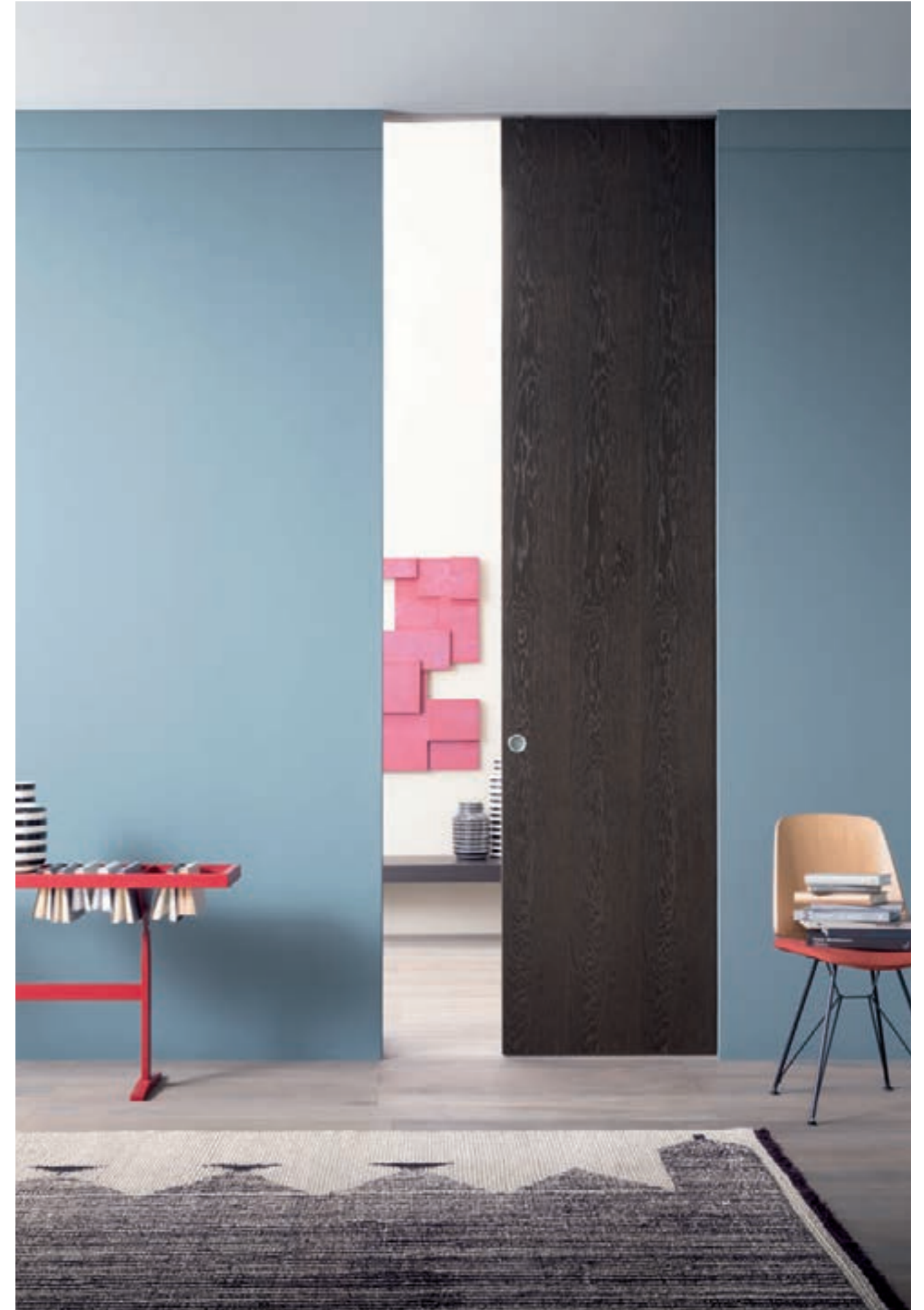

La porta scorrevole all'interno del muro è essenziale per la sua purezza formale.

The sliding pocket door has an essential and formal purity.

Architectural Collection

[180 - 237]

È la collezione di porte d'autore e comprende sia modelli storici che contemporanei dai linguaggi espressivi diversi ma uniti dal comune denominatore dell'essenzialità visiva del loro disegno. Sono porte con stipite in alluminio e solitamente con dedicato falso telaio metallico.

This is the collection of designer doors and includes both past and contemporary models with different expressive languages but united by the common denominator of the visual essentiality of their design. The doors have aluminium jambs and are normally provided with a special metal door frame.

L7

Disegnati da Piero Lissoni nella versione battente, i due modelli L7 sono una presenza lieve e funzionale che sa vivere con garbo in ambienti di gusto contemporaneo. Grazie alla gamma di finiture è possibile definirne la personalità, in relazione all'impatto che si desidera ottenere: dalla naturalità delle sfumature chiare alle superfici retroverniciata in colori lucidi o opachi.

Designed by Piero Lissoni the hinged L7, available in two models, forms a light and functional presence able to inhabit contemporary settings with poise and refinement. Thanks to the range of finishes, the personality can be defined according to the effect desired: from the naturalness of the lighter shades to the gloss or matt back-painted surfaces.





Attraversato dalla luce, il vetro con retina metallica bronzo restituisce ombre dorate. L'anta è a battente, il profilo bronzo.

Traversed by the light, the glass with a bronze metallic lattice renders golden shadows. The door is hinged, the profile bronze.



Il disegno slanciato di L7 versione battente, con profilo in acciaio e vetro retroverniciato bianco, conferisce leggerezza all'ambiente circostante.

With its steel profile and white back-painted glass, the sleek design of L7 in the hinged version confers lightness on the surrounding space.





L7 in versione battente con stipite metallico di 18 mm, profilo in acciaio e vetro retroverniciato bianco.

The hinged version of L7 with 18 mm metal jamb, metal profile and white back-painted glass.





La luminosità di L7 in versione a battente con profilo in bronzo è esaltata dai giochi di rifrazione di Marks extrachiaro satinato.

The luminosity of L7 in the hinged door version with a bronze profile is enhanced by the play of light refractions of the extra-clear satinated Marks.





La porta L7 scorrevole a scomparsa con profilo nero e anta in vetro con retina damier, un pattern grafico dal delicato effetto 'trompe l'oeil'.

The L7 pocket door with black profile and glass door with damier mesh, a pattern with a delicate 'trompe l'oeil' effect.







L7 Large

A battente, L7 Large è una porta contemporanea per concezione, uso di materiali e tecnologie, ma classica per estetica. Di linea nitida ed essenziale si presta ad arredare gli ambienti più diversi grazie a una scelta di finiture che giocano con la luce e le trasparenze del vetro e la sofisticata eleganza del metallo.

The L7 Large hinged door is contemporary in its conception, use of materials and technologies, but classic in its aesthetics. With its clean and sober form, it lends itself to furnishing the most diverse settings thanks to a choice of finishes that play with the light and the transparency of glass and the sophisticated elegance of metal.

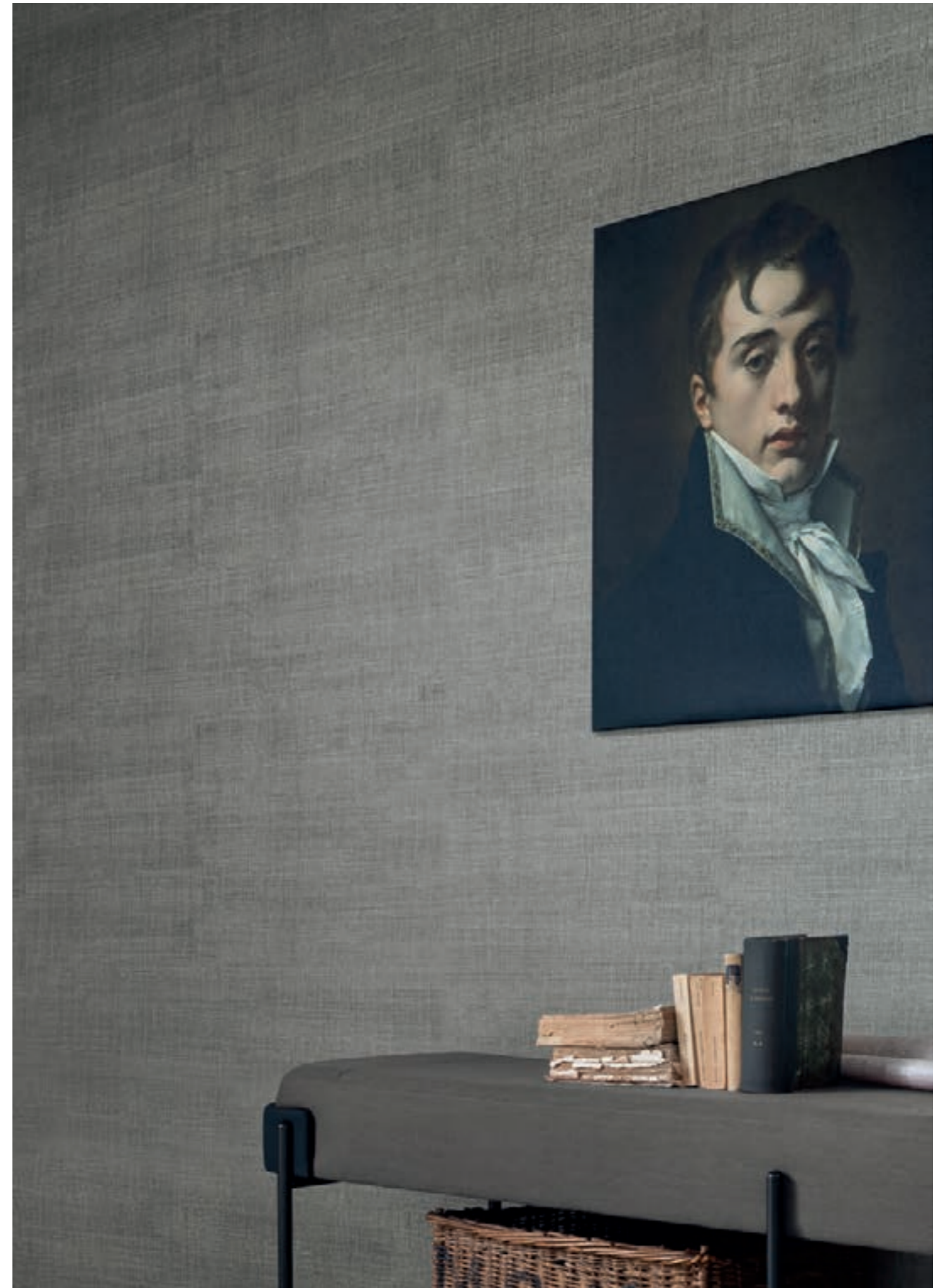

L7 Large in versione battente con coprifilo incorporato e stipite di 65 mm verniciato bianco. La superficie dell'anta è in vetro satinato.

L7 Large in the hinged version with built in casing and white-painted 65 mm jamb. The surface of the door is in frosted glass.



Grande luminosità per L7 Large con maniglia e stipite bianchi e vetro satinato.

A highly luminous L7 Large with white handle and jamb, in frosted glass.



Una bellezza materica e naturale
per L7 Large con anta in rovere
precomposto e profilo nero
opaco.

A materic and natural beauty
for L7 Large with oak doors
and a matt black profile.





Un volume nitido che ha il calore e la vita del legno, sottolineato dall'eleganza del nero opaco del profilo.

A clear-cut volume that possess the warmth and life of wood, accented by the elegance of the matt black of the profile.

Produce un effetto di morbida luce diffusa questa L7 Large a battente con vetro grigio satinato e profilo nero opaco.

This L7 Large hinged door with grey satined glass and matt black profile produces an effect of soft diffused light.



L41

Progettata da Piero Lissoni, L41 è connotata da un sottile stipite in metallo a valorizzarne il profilo agile. Le finiture diverse creano esiti materici e cromatici, di originale bellezza.

Designed by Piero Lissoni, L41 is distinguished by a thin metal jamb which enhances the light profile. The different finishes provide interesting combinations of materials and colors and a unique beauty.



Una presenza originale capace di valorizzare lo spazio per la linea sofisticata, creata dal contrasto fra l'effetto di profondità dello stipite in alluminio di gusto high tech e la perfetta complanarità di parete e anta.

Forming an original presence, it enhances the space through its sophisticated line created by the contrast between the depth of the aluminium door jamb and the flushness of the wall and door.





Dettaglio dello stipite in alluminio:
una pelle high-tech che corre
lungo tutto il perimetro.

Detail of the doorframe
in aluminium: high-tech leather
edges the entire length of the
perimeter.







Stipite e maniglia in finitura acciaio satinato fanno del metallo il leitmotiv.

Jamb and handle in a satin steel finish make metal the leitmotiv.



Super

Uno dei modelli storici firmato da Luigi Caccia Dominioni. L'anta, dal bordo arrotondato, è incorniciata dallo stipite in alluminio che ne esalta la superficie ampia e pulita.

One of the classic models designed by Luigi Caccia Dominioni. The door, with its rounded edges, is surrounded by the aluminium jamb which exalts the clean and ample surface.





Il morbido bordo arrotondato dell'anta di Super esalta la superficie riflettente in poliester lucido.

The soft rounded edge of the Super door enhances the reflective surface in gloss polyester.



Outline

Disegnata da Erik Morvan, offre allo sguardo un volume puro, una superficie tridimensionale, vero e proprio elemento architettonico in grado di definire lo spazio. Fra i vantaggi tecnici: si monta direttamente su parete a lavori finiti ed è realizzabile su misura in diverse altezze.

Designed by Erik Morvan, the pure volume and three-dimensional surface create a piece of architecture able to lend definition to a space. It is mounted directly onto the wall and available in a variety of heights.

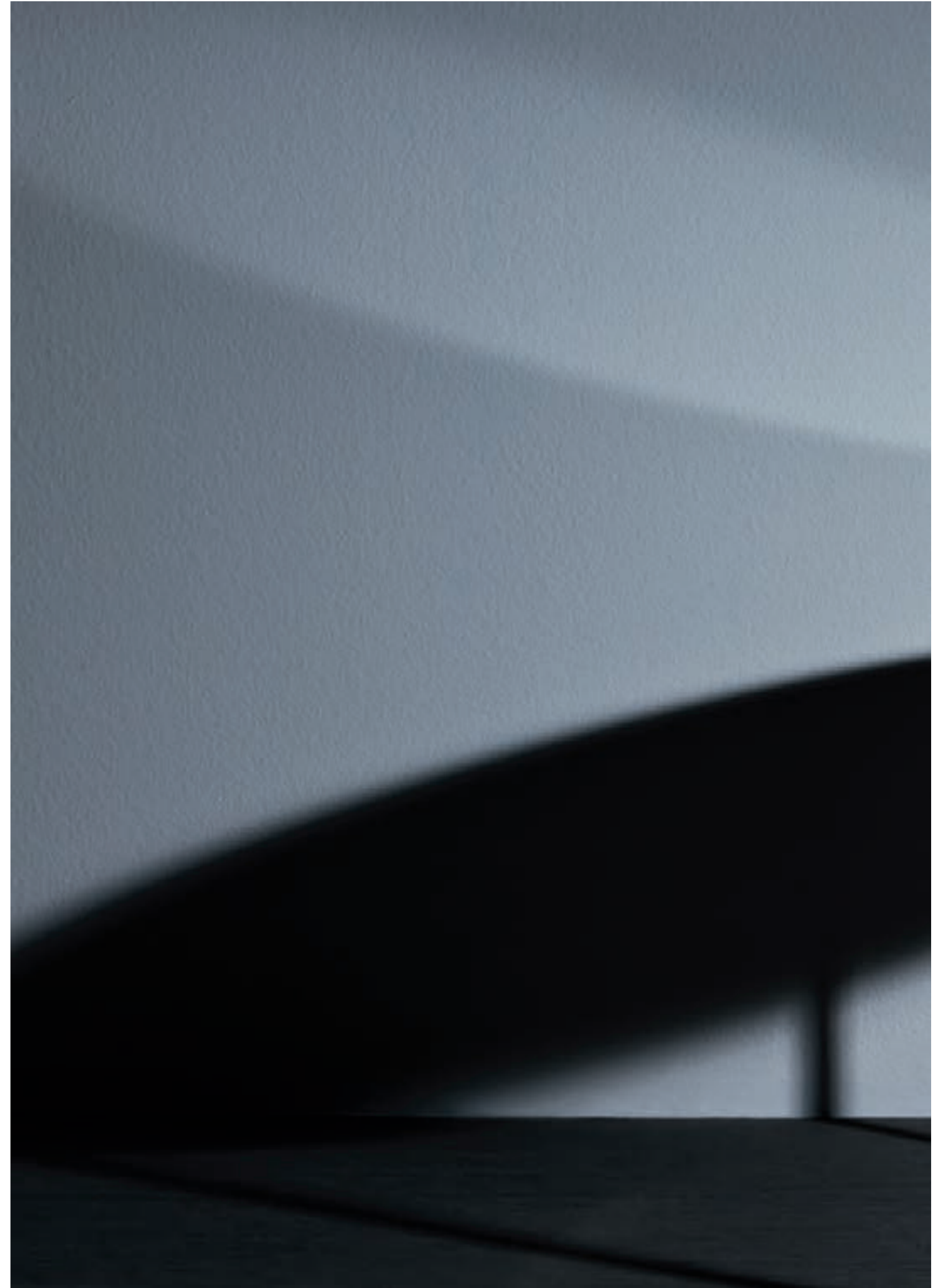





L'impiallacciatura verticale del rovere tinto grigio si legge come una texture elegantemente naturale.

The vertical veneer of the grey tinted oak creates an elegantly natural texture.



Drive

Può leggersi come bella superficie semplicemente appoggiata alla parete, questa anta scorrevole la cui tecnologia, completamente a scomparsa, permette di ottenere effetti di grande leggerezza.

This sliding door can be seen as a beautiful surface simply laid against the wall. The technology is totally invisible and creates an effect of extraordinary lightness.

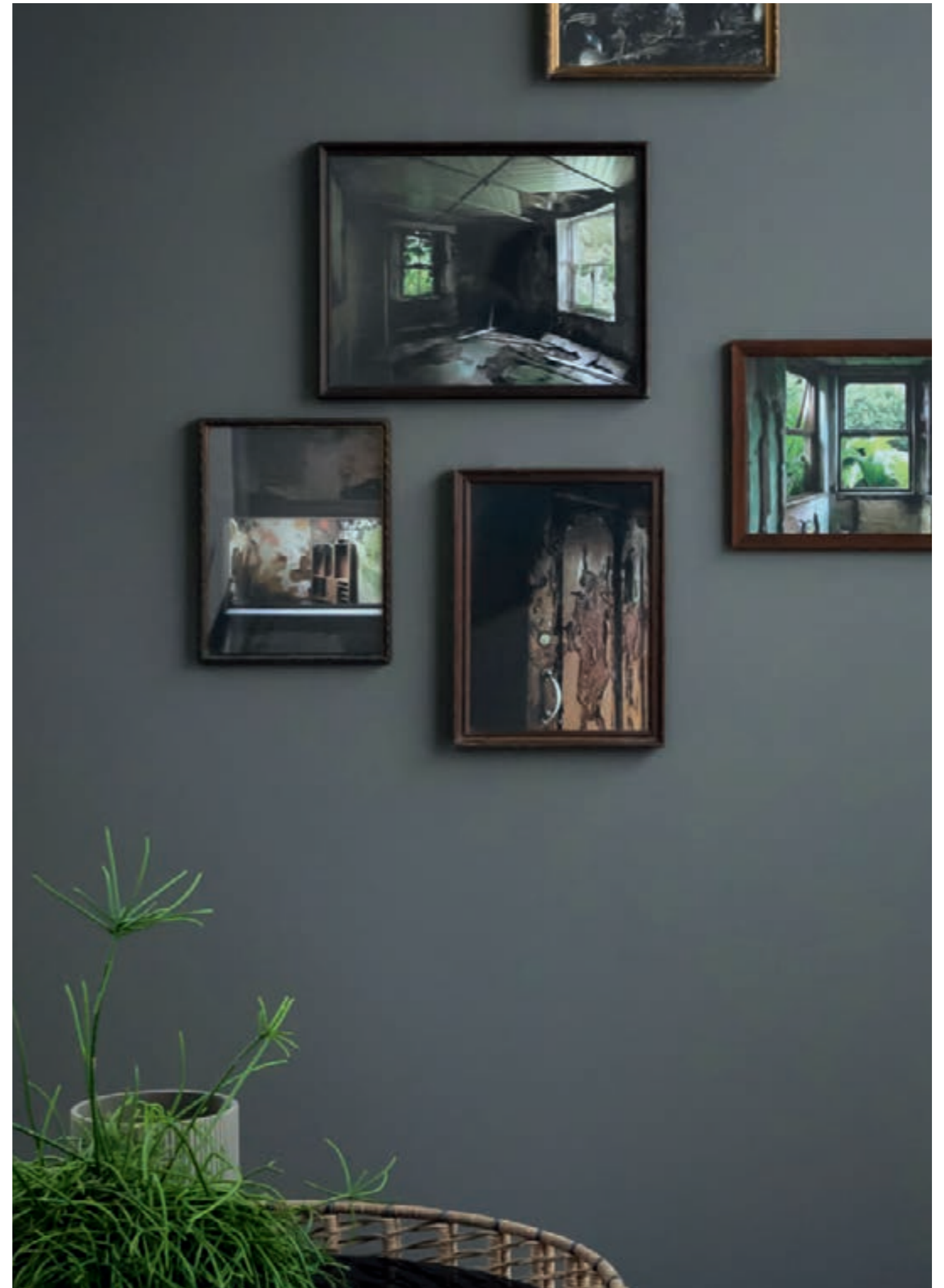





Home Collection

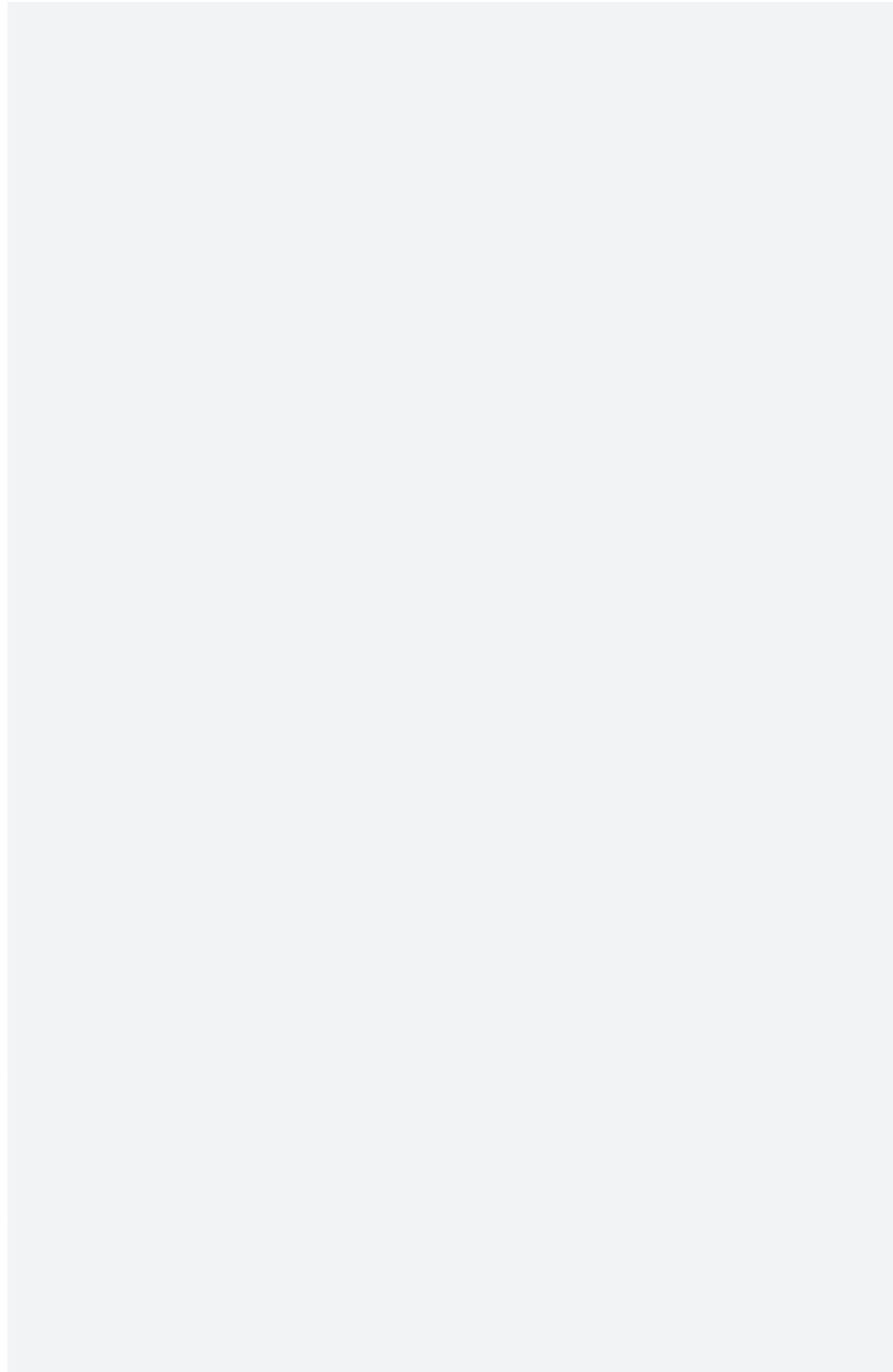

Fanno parte della Home Collection le porte di tradizionale memoria storica, montate su falso telaio in legno e con coprifili classici, rese contemporanee nel disegno e nel linguaggio espressivo leggero, in sintonia e continuità con i diversi stili dell'architettura degli interni.

The Home Collection includes the doors of historic tradition mounted on a wooden frame and with classic trim, rendered contemporary in its design and in the light expressive language, in harmony and continuity with the different styles of interior architecture.

Filo 55 s-t

Perfettamente complanare a stipite e parete, associa alla purezza della superficie una linea slanciata. Grazie alla battuta rovesciata e all'apertura verso l'interno, ottiene un elegante effetto di continuità con i lati del corridoio. Disponibile con apertura a spingere, Filo 55 s, o a tirare Filo 55 t, ha natura versatile e si adatta a muratura, cartongesso e sistemi di pareti mobili.

With the frame and walls perfectly flush, the slim form blends with the purity of the surfaces. The reversed edge and the opening to the interior confer a stylish effect of continuity with the sides of the corridor. Available with push opening, Filo 55 s, or pull opening, Filo 55 t, it is versatile and adapts to solid wall, plasterboard and moveable wall systems.









Con apertura a spingere, Filo 55 s, o a tirare Filo 55 t, sono adatte per essere inserite a muratura, cartongesso e sistemi di pareti mobili.

Filo 55 s with push opening or Filo 55 t with pull opening are suitable for insertion in masonry, plasterboard and mobile wall systems.





Battuta rovesciata e apertura verso l'interno per un elegante effetto di continuità con la superficie delle pareti.

The reversed edge and opening towards the inside confer an elegant continuity with the surface of the walls.

Lcd62

Un modello storico, disegnato da Luigi Caccia Dominioni riproposto in un'evoluzione che coinvolge tecnica ed estetica. A renderne più flessibili gli usi sono l'anta reversibile, la cerniera a scomparsa e il telaio telescopico, grazie a cui il modello si adatta a diversi spessori di muratura. Proporzioni e finiture accendono la linea classica di note contemporanee.

An historic model, designed by Luigi Caccia Dominioni, that has evolved both technically and aesthetically. The reversible door, the concealed hinge and the adjustable jamb which adapts to a variety of wall thicknesses, all allow more flexibility in the range of uses. Proportions and finishes lend a contemporary note to this classic line.

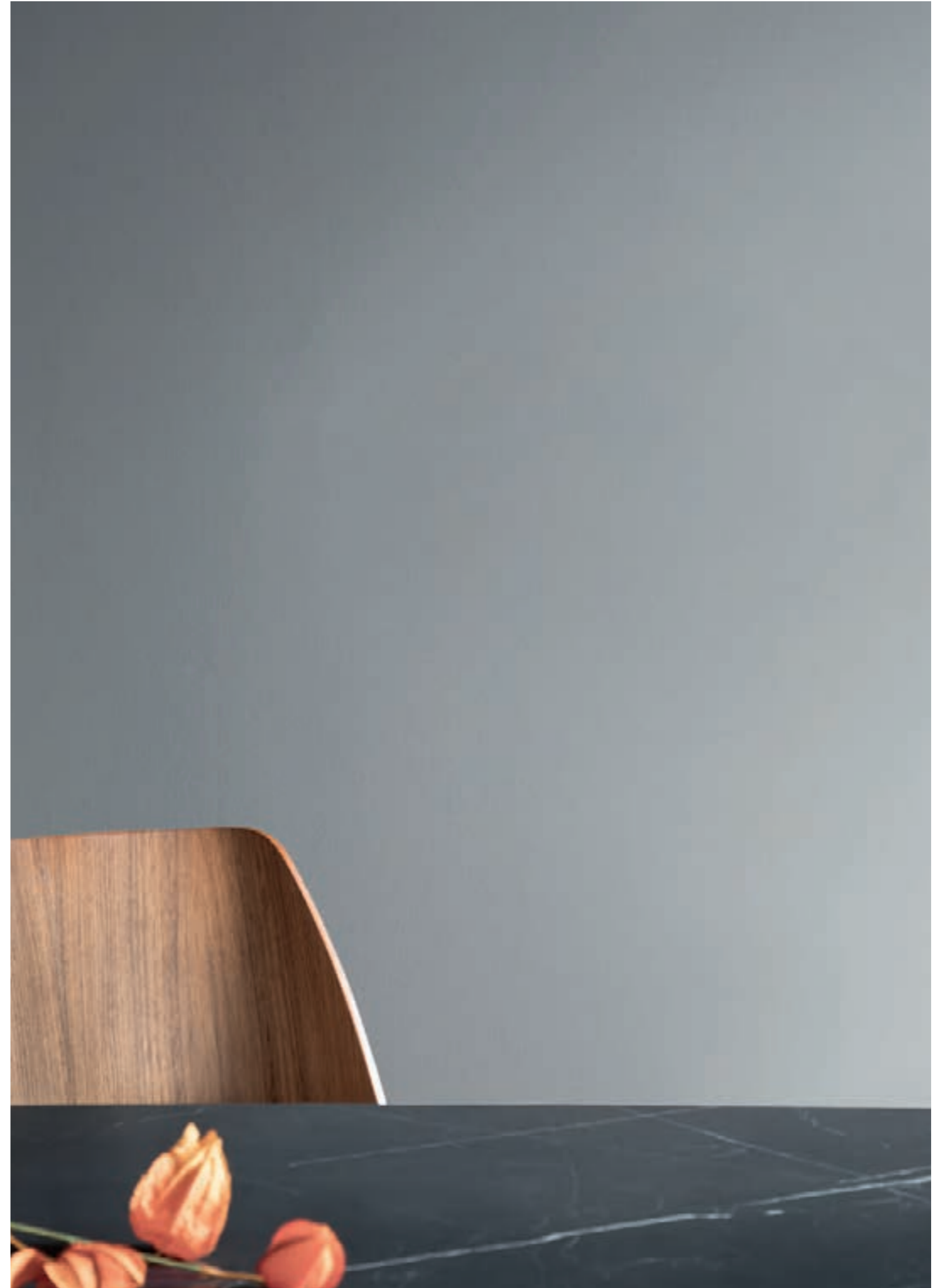





La complanarità dello stipite con l'anta danno eleganza e raffinatezza alla parete.

The flushness of the jamb and door lends elegance and refinement to the wall.



Dettaglio dello stipite esterno,
interno e della battuta con
guarnizione.

Detail of the external and internal
trim and the striker seal.



Avenue

Robert A. M. Stern abbina la sofisticatezza italiana a un gusto tipicamente americano, per creare una serie di tre porte nello stile tradizionale-moderno caratteristico del suo lavoro. Le specchiature, dai dettagli vivaci con finitura in legno laccato, reinterpretano le porte degli appartamenti classici della New York anteguerra. Le porte sono disponibili con specchiatura singola, doppia o tripla. Simmetriche ed equilibrate, con i loro dettagli in puro stile americano, sottili e senza tempo, completano una vasta gamma di interni contemporanei e sono adatte sia per l'arredamento residenziale, che per quello da ufficio e per il settore dell'ospitalità.

Robert A. M. Stern combines Italian sophistication with a distinctly American flavor to create a series of three doors in the modern traditional style that is so characteristic of his work. The matt finished paneling details reinterpret the doors of a classic New York pre-war apartment. The doors are available with single, double or triple paneling. Symmetric and balanced, they complement a range of contemporary interiors with subtle, timeless, American details, and are suitable for residential settings as well as hospitality and office applications.





Particolare dello stipite e dell'anta
in laccato opaco colore terra.

Detail of the trim and door
in matt lacquer Earth color.





Porta laccata opaco bianco nella versione con una specchiatura.
Door in a matt white finish with one panel.

Porta laccata opaco bianco nella versione con due specchiature.
Door in a matt white finish with two panels.



Porta laccata opaco bianco nella versione con tre specchiature e decoro.

Door in a matt white finish with three panels and decoration.

Porta laccata bianco opaco nella versione a tre specchiature.

Door in a matt white finish with three panels.



San Siro

Disegnata da Luigi Caccia Dominioni, recupera le forme della tradizione, interpretandone lo spirito classico in chiave moderna. Il gioco di proporzioni e il disegno delle fasce laterali introducono un elemento di lieve dissonanza in una composizione di grande misura, fatta per abitare con facilità ogni tipo di spazio.

Designed by Luigi Caccia Dominioni, this rediscovery of the traditional form interprets the classic spirit in a modern tone. The play of proportions and the design of the side strips introduce a lightly dissonant element into a composition of great dimension, created to fit easily into any type of space.





La rigidità della maniglia
Martina è associata al disegno
classico della porta.

The austerity of the Martina
handle is associated with the
door of classic design.





[272 - 311]

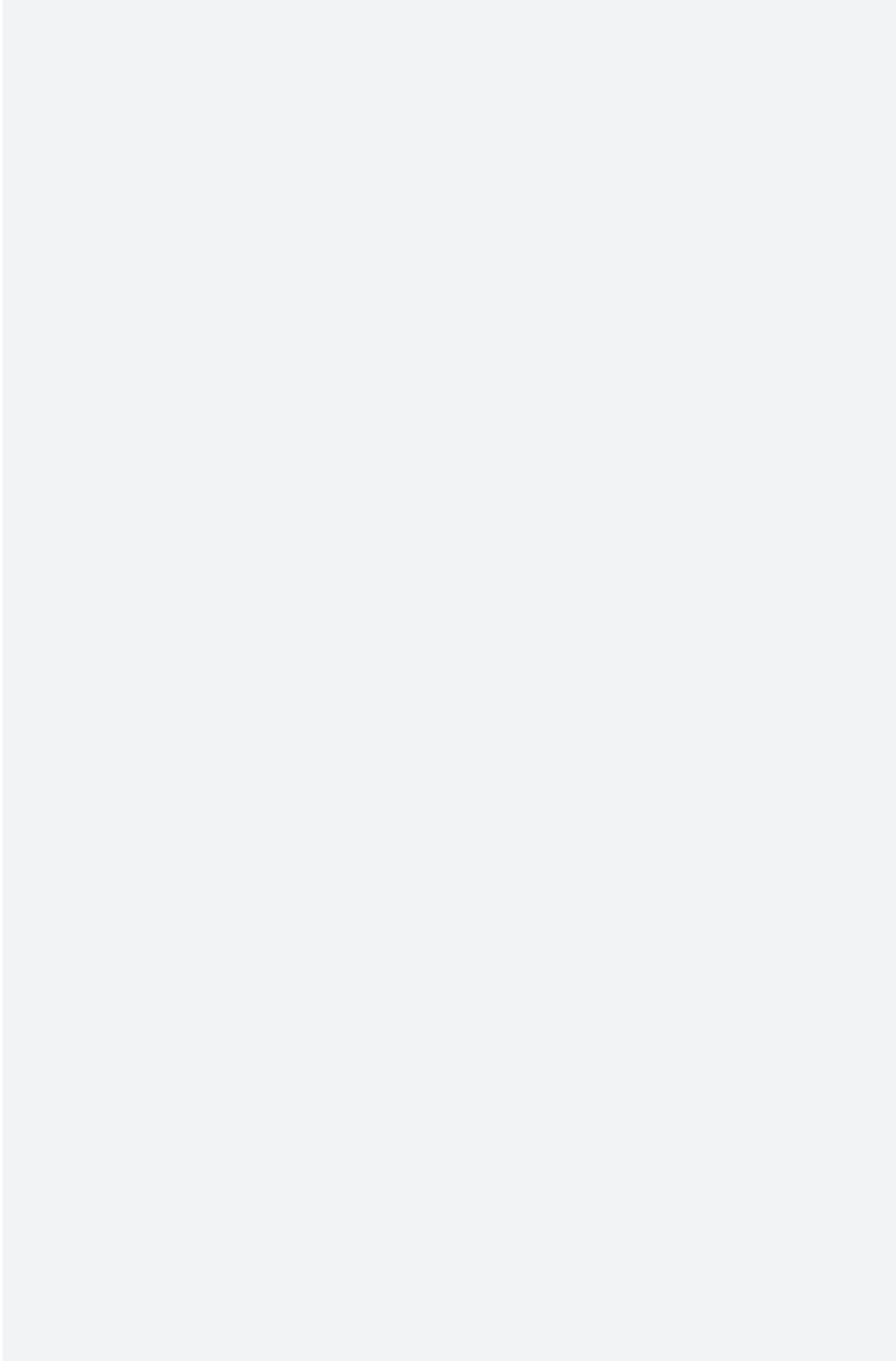

*Technical drawings,
Handles, Finishes*

**Shoin / Koan
sistema scorrevole**

Anta di spessore 50 mm, configurabile in diversi sistemi di pannelli scorrevoli e fissi, disponibile con vetro di sicurezza spessore 6 mm e profilo in alluminio. Binario con sistema decelerante e carrello con meccanismo di regolazione in altezza.

Door leaf 50 mm (2") thick, available with fixed and sliding panels and with 6 mm (1/4") thick safety glass and aluminium trim. Track with damper system and trolley hanger with height adjustment mechanism.

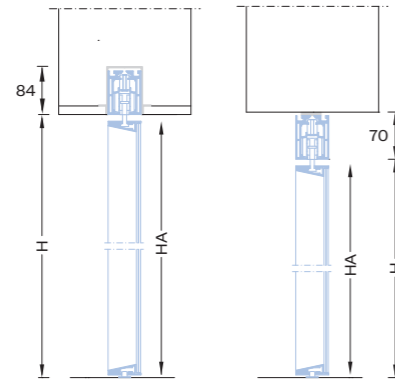

Binario singolo / Single track

L
luce netta / opening width
600-1400 mm 23 5/8" - 55 1/2"
H
altezza netta / opening height
max 3000 mm 118 1/4"
HA
misura anta / panel sizes
H - 14 mm

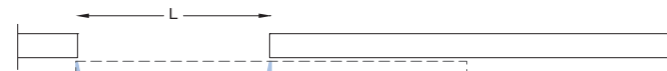

Anta singola esterno muro / External single door leaf



Due ante esterno muro / External double door leaves

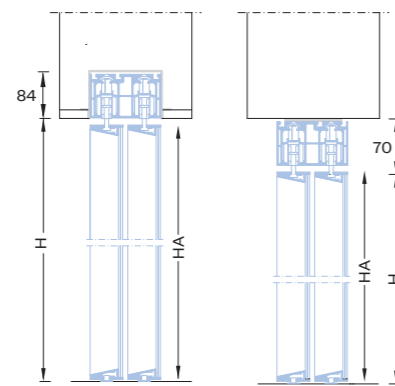

Binario doppio / Double track

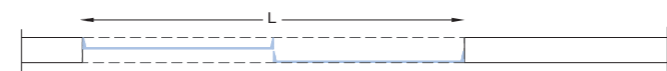

Due ante interno muro / Internal double door leaves



Quattro ante interno muro / Internal four door leaves

Shoin Pivot

Porta a bilico di spessore 50 mm, configurabile in diversi sistemi di pannelli apribili e fissi, disponibile con vetro di sicurezza spessore 6 mm e profilo in alluminio. Completa di serratura e perni di fissaggio. Binario a soffitto.

Pivoting door 50 mm (2") thick that can be configured in different systems with fixed and pivoting panels, available in 6 mm (1/4") thick safety glass and profile in aluminium. Complete with lockset and pivot hinges. Track available for fixed panels. Recessed or ceiling surface mounted.

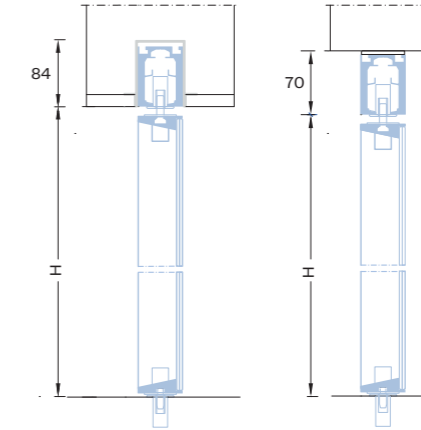

L
larghezza pannello apribile /
width opening panel
cm 80 - 120 31 1/2" - 47 1/4"
LP
larghezza pannello fisso /
width fixed panel
cm 60 - 120 23 5/8" - 47 1/4"
H
altezza luce netta / opening height
cm max 300 118 1/4"

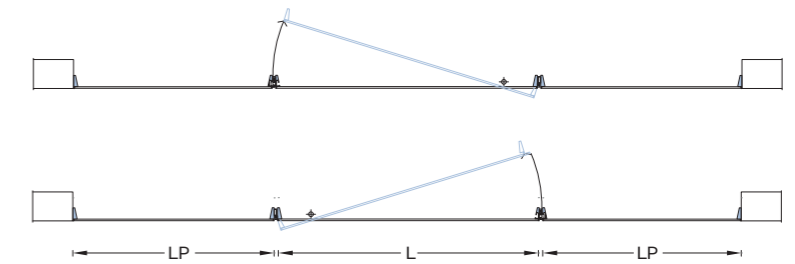

L7

L7 a battente, spessore 41 mm, con vetro di sicurezza 6 mm. Telaio perimetrale del vetro in alluminio trattato in diverse finiture. Cerniere a scomparsa, guarnizioni di battuta. Serratura magnetica. Sistema telescopico dello stipite da 100 a 130 mm.

L7 con stipite telescopico in alluminio da montare su falso telaio dedicato. L7 LARGE con stipite telescopico in alluminio da montare su falso telaio tradizionale.

L7 / L7 Plus scorrevole, sistema di ante fisse e scorrevoli con spessore 41 mm realizzate su misura. Ante in vetro di sicurezza 6 mm. Telaio di contenimento del vetro in alluminio trattato in diverse finiture. Binario a una o due vie, sistema di freno decelerante. Meccanismo di regolazione in altezza nascosto nel carrello del binario.

L7 hinged door mm 41 thick in safety glass, mm 6 thick. Aluminium frame in different finishes. Concealed hinges and door striker seal. Magnetic lock set.

Telescopic jamb from mm 100 to 130. L7 with a telescopic jamb to be installed on dedicated subframe. L7 LARGE with a telescopic jamb in aluminium to be installed on traditional subframe.

L7 / L7 Plus sliding door, system with fixed and sliding panels mm 41 thick, custom made. Leaf with safety glass mm 6 thick and aluminium frame in different finishes. Single or double rail with damper system and trolley hanger with height adjustment mechanism.

L7

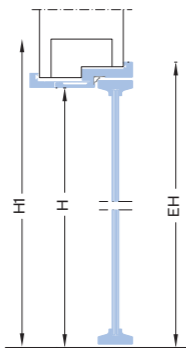
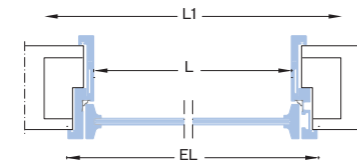

L
luce netta / opening width
600-900 mm 23 5/8"- 35 3/8"
H
altezza netta / opening height
max 3000 mm 118 1/4"
EL
ingombro totale / overall sizes
L + 59 mm
EH
ingombro totale / overall sizes
H + 30 mm
L1
vano muro / rough opening
L + 100 mm
H1
vano muro / rough opening
H + 50 mm

L7 Large

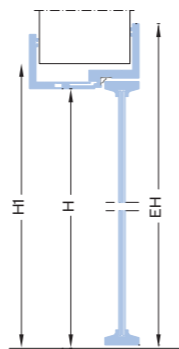
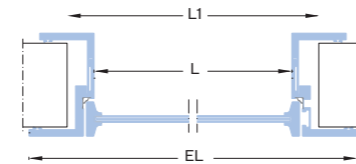

L
luce netta / opening width
600-900 mm 23 5/8"- 35 3/8"
H
altezza netta / opening height
max 3000 mm 118 1/4"
EL
ingombro totale / overall sizes
L + 190 mm
EH
ingombro totale / overall sizes
H + 96 mm
L1
vano muro / rough opening
L + 100 mm
H1
vano muro / rough opening
H + 50 mm

L7 / L7 Plus Scorrevole

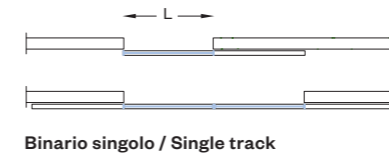

Binario singolo / Single track

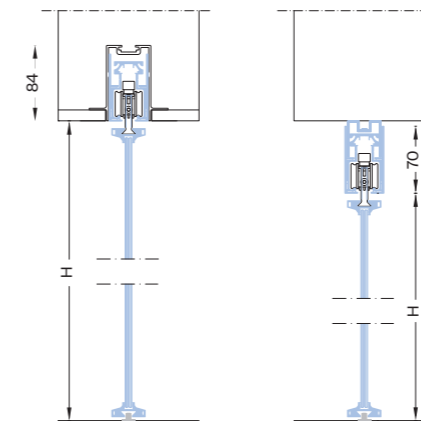

L
luce netta / opening width
600-1400 mm 23 5/8"- 55 1/2"
H
altezza netta / opening height
max 3000 mm 118 1/4"

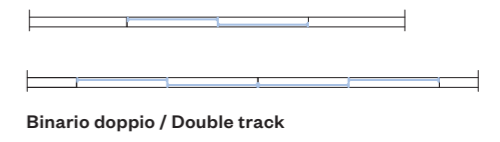

Binario doppio / Double track

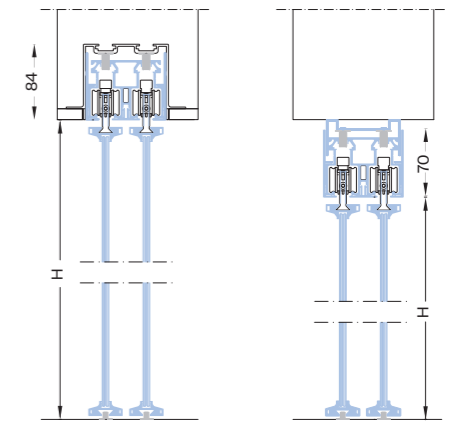

Sliding 50

Anta di spessore 50 mm configurabile in diversi sistemi di pannelli scorrevoli e fissi, disponibili in essenza o laccato. Binario con sistema decelerante e carrello con meccanismo di regolazione in altezza.

The mm 50 thick door can be configured in different sliding and fixed panel systems, and is available veneered or lacquered. Track with a damper system and height adjustment mechanism.

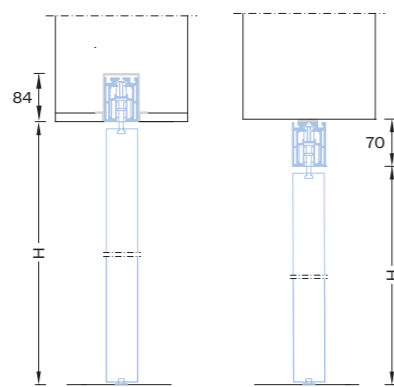

Binario singolo / Single track



Anta singola esterno muro / External single door leaf

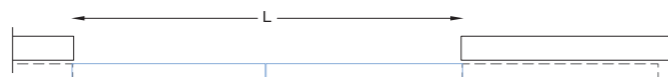

Due ante esterno muro / External double door leaves

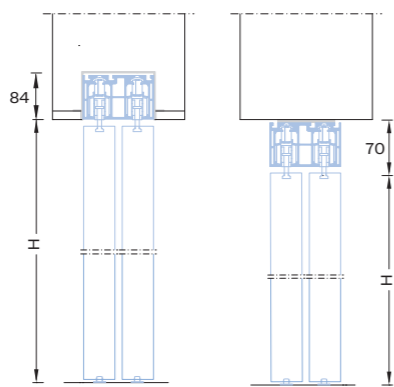

Binario doppio / Double track



Due ante interno muro / Internal double door leaves

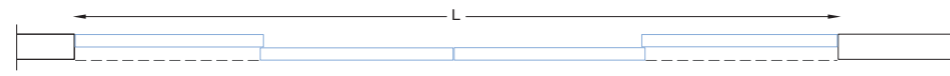

Quattro ante interno muro / Internal four door leaves

L
luce netta / opening width
600-1400 mm 23 5/8" - 55 1/2"
H
altezza netta / opening height
max 3000 mm 118 1/4"
LA
misura anta / panel sizes
L + 40 mm

Wall&Door

Sistema costituito da pannelli fissi ed apribili realizzati su misura, entrambi prevedono una struttura tamburata di spessore 55 mm, finitura laccato lucido o opaco o in essenze di serie. Impiallacciatura orizzontale solo su richiesta. Completa di ferramenta, cerniere a scomparsa.

Wall system made of custom-made fixed and hinged panels. Hollow-core construction, mm 55 thick. Finishes available: vertical wood veneer, matt and gloss lacquered. Horizontal veneer on request. Complete with hardware and concealed hinge.

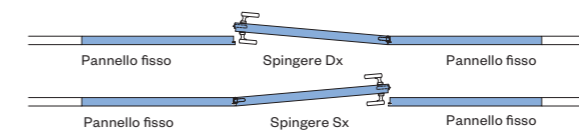

Wall&Door a battente / Swing door

LP
larghezza pannello fisso / width fixed panel
100-1200 mm
larghezza pannello apribile / width opening panel
600-1200 mm
H
altezza netta / opening height
max 3000 mm 118 1/4"

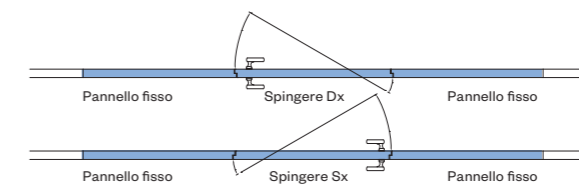
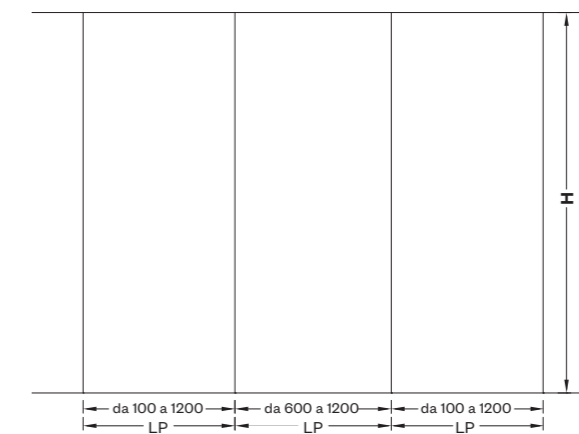

Wall&Door compass / Offset door

LP
larghezza pannello fisso / width fixed panel
100-1200 mm
larghezza pannello apribile / width opening panel
600-1200 mm
H
altezza netta / opening height
max 3000 mm 118 1/4"

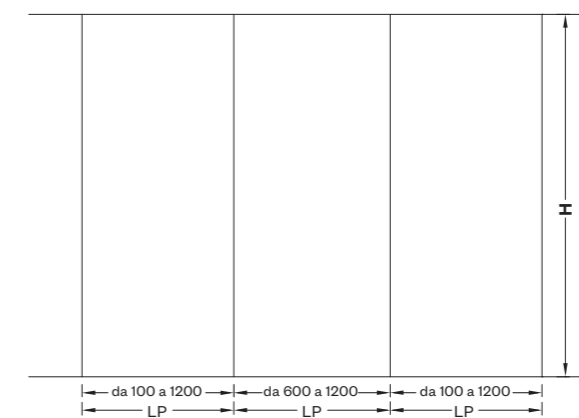

Avenue Boiserie

Le boiserie Avenue vengono eseguite su disegno utilizzando pannelli con rilievo geometrico su un lato, nelle finiture laccato opaco. Dimensioni: larghezza da 600 mm a 1200 mm; altezza fino a 2900 mm.

The Avenue boiserie is custom-made based on architectural drawings, using geometrically shaped panels on one side and available in matt lacquer finishes.

Dimensions: width from mm 600 (23 5/8") to mm 1200 (47 1/4"); height max mm 2900 (23 5/8").

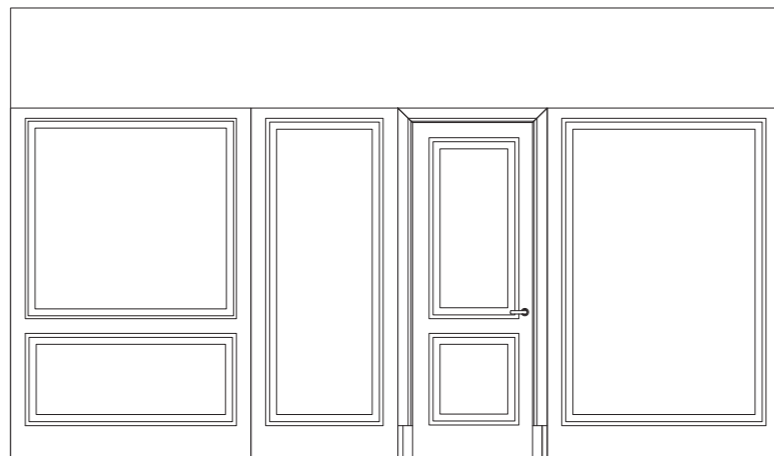
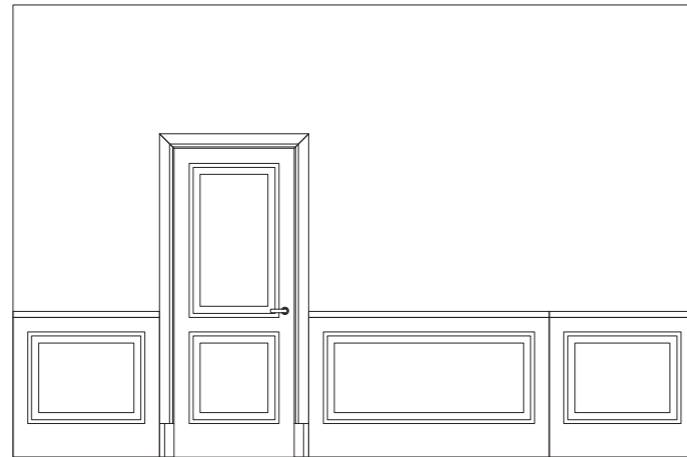

Edge Boiserie

Le boiserie Edge vengono eseguite su disegno utilizzando pannelli con rilievo geometrico su un lato, nelle finiture laccato opaco. Dimensioni: larghezza da 600 mm a 1200 mm; altezza fino a 3000 mm.

The Edge boiserie is custom-made based on architectural drawings, using geometrically shaped panels on one side and available in matt lacquer finishes.

Dimensions: width from mm 600 (23 5/8") to mm 1200 (47 1/4"); height max mm 3000 (23 5/8").



Esempio boiserie Edge / Example of boiserie Edge

Rasomuro 55s

Anta a battente in tamburato, spessore 55 mm.

Finiture del battente: grezzo con una mano di fondo; laccato opaco e laccato lucido nei colori di serie o essenze. Telaio in alluminio; non necessita di falso telaio. Guarnizione di battuta. Cerniera a scomparsa regolabile.

Hollow-core hinged door, mm 55 thick. Door panel: unfinished with a primer coat, gloss or matt lacquered from the standard color range, or veneered. Aluminium frame for direct wall installation. Subframe not necessary. Door striker seal. Adjustable concealed hinges.

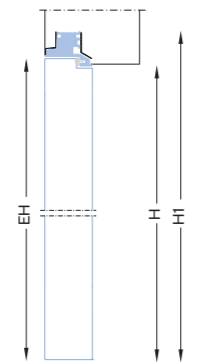
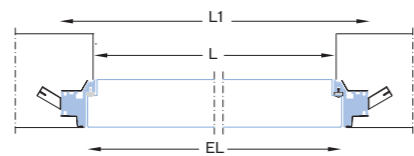
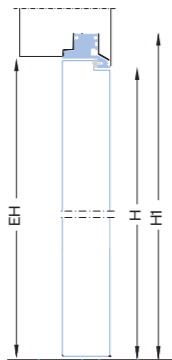
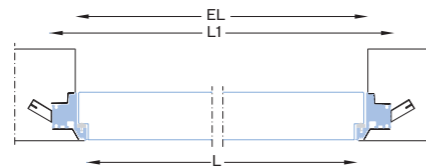

RM55s spingere per muratura / Brickwall push opening

L
luce netta / opening width
600-900 mm 23 5/8"- 35 3/8"

H
altezza netta / opening height
max 3000 mm 118 1/4"

L1
vano muro / rough opening
L + 100 mm

H1
vano muro / rough opening
H + 50 mm

EL
ingombro totale / overall sizes
L + 28 mm

EH
ingombro totale / overall sizes
H + 14 mm

RM55s tirare per muratura / Brickwall pull opening

L
luce netta / opening width
600-900 mm 23 5/8"- 35 3/8"

H
altezza netta / opening height
max 3000 mm 118 1/4"

L1
vano muro / rough opening
L + 100 mm

H1
vano muro / rough opening
H + 50 mm

EL
ingombro totale / overall sizes
L + 28 mm

EH
ingombro totale / overall sizes
H + 14 mm

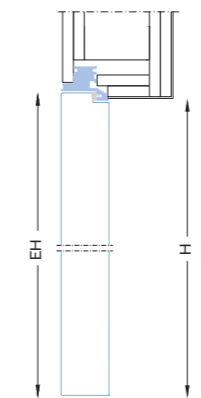
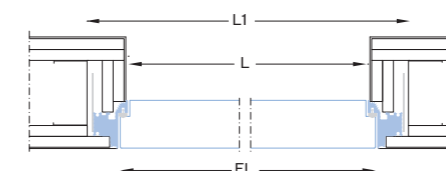
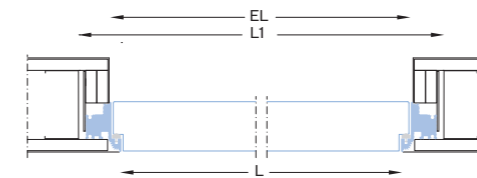

RM55s spingere per cartongesso / Drywall push opening

L
luce netta / opening width
600-900 mm 23 5/8"- 35 3/8"

H
altezza netta / opening height
max 3000 mm 118 1/4"

L1
vano muro / rough opening
L + 100 mm

H1
vano muro / rough opening
H + 50 mm

EL
ingombro totale / overall sizes
L + 28 mm

EH
ingombro totale / overall sizes
H + 14 mm

RM55s tirare per cartongesso / Drywall pull opening

L
luce netta / opening width
600-900 mm 23 5/8"- 35 3/8"

H
altezza netta / opening height
max 3000 mm 118 1/4"

L1
vano muro / rough opening
L + 100 mm

H1
vano muro / rough opening
H + 50 mm

EL
ingombro totale / overall sizes
L + 28 mm

EH
ingombro totale / overall sizes
H + 14 mm

Rasovetro 55s

Battente spessore 55 mm con telaio perimetrale in alluminio e lastre di vetro temperato spessore 4 mm da entrambi i lati. Vetri finiture di serie. Telaio in alluminio.

Hinged door, mm 55 thick, with aluminum frame and mm 4 tempered glass thick on both sides. Finishes from the standard range.

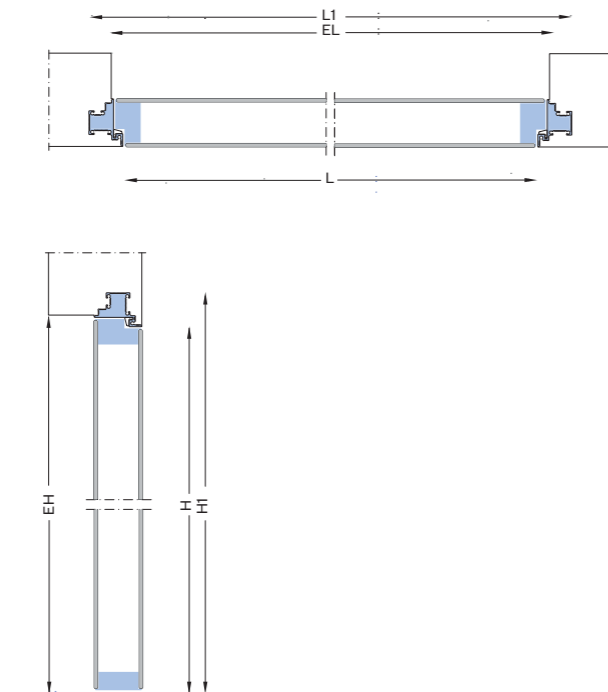

L
luce netta / opening width
600-900 mm 23 5/8" - 35 3/8"

H
altezza netta / opening height
max 3000 mm 118 1/4"

L1
vano muro / rough opening
L + 100 mm

H1
vano muro / rough opening
H + 50 mm

EL
ingombro totale / overall sizes
L + 28 mm

EH
ingombro totale / overall sizes
H + 14 mm

Rasotouch 55s

Battente spessore 55 mm con maniglia a scomparsa, l'apertura è ottenuta con pressione della fascia verticale. Battente laccato opaco, lucido o in essenza di serie. Fascia a pressione sempre laccata colore opaco. Telaio in alluminio.

Hinged wood door, mm 55 thick, with a concealed handle operated by pushing the vertical strip. Finished in matt or gloss lacquer or wood veneer from the standard range, while the vertical strip of the handle is always matt lacquered. Aluminum frame.

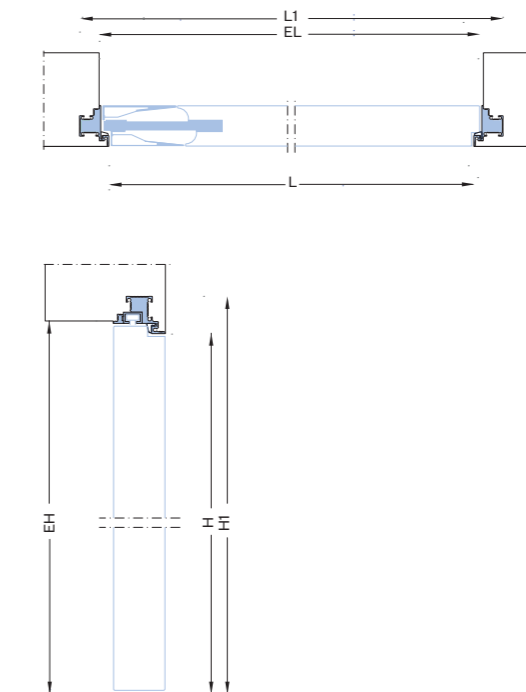

L
luce netta / opening width
600-900 mm 23 5/8" - 35 3/8"

H
altezza netta / opening height
max 3000 mm 118 1/4"

L1
vano muro / rough opening
L + 100 mm

H1
vano muro / rough opening
H + 50 mm

EL
ingombro totale / overall sizes
L + 28 mm

EH
ingombro totale / overall sizes
H + 14 mm

Rasoline 55s

Anta di spessore 55 mm in legno a struttura tamburata e bordo in alluminio. Completa di serratura magnetica, cerniere a scomparsa regolabili sui tre assi e guarnizioni di battuta.

Telaio in alluminio anodizzato preassemblato da murare senza falso telaio. L'anta può essere ridotta di spessore fino a 4 mm su entrambi i lati per accogliere rivestimenti di diversi materiali.

Hinged hollow-core wood door, with edges in aluminium, mm 55 (2 3/16") thick. Complete with magnetic lockset, concealed 3-way adjustable hinges and striker seal.

Anodized aluminium frame to be installed without need of any subframe. The door can be reduced in thickness up to mm 4 (1/8") on each side to accommodate claddings of different materials.

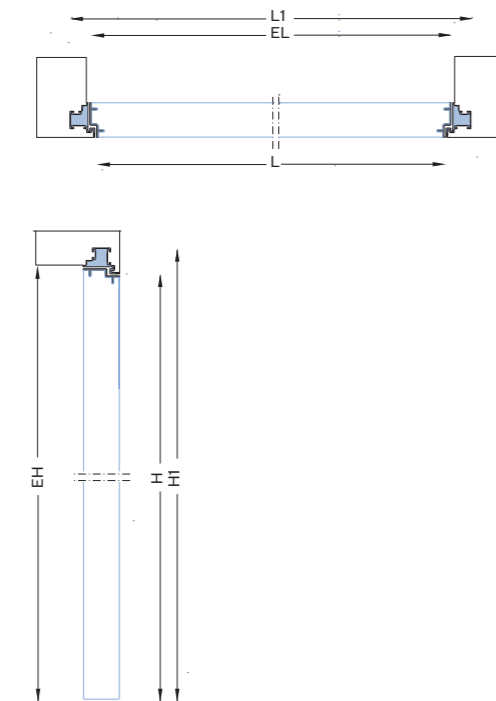

L
luce netta / opening width
600-900 mm 23 5/8" - 35 3/8"

H
altezza netta / opening height
max 3000 mm 118 1/4"

L1
vano muro / rough opening
L + 100 mm

H1
vano muro / rough opening
H + 50 mm

EL
ingombro totale / overall sizes
L + 28 mm

EH
ingombro totale / overall sizes
H + 14 mm



Versione bordo alluminio / Aluminium edge version

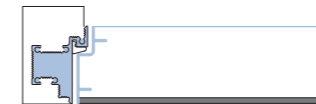

Ribasso (da 1 a 4 mm) - lato a tirare / Pull side lowered (from 1 to 4 mm)

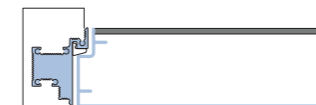

Ribasso (da 1 a 4 mm) - lato a spingere / Push side lowered (from 1 to 4 mm)

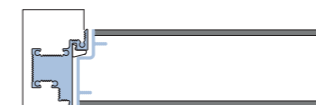

Ribasso (da 1 a 4 mm) - entrambi i lati / Both side lowered (from 1 to 4 mm)

Edge

La porta Edge può essere montata sui telai Rasomuro 55s.
Battente tamburato, spessore 63 mm
finitura del battente laccato opaco colori di serie.
Rilievo lato a spingere o tirare.

The Edge door can be mounted on Rasomuro 55s frames.
Hollow-core hinged door, thickness mm 63, matt lacquered finish from the standard color range.
Shaped on push or on pull side.

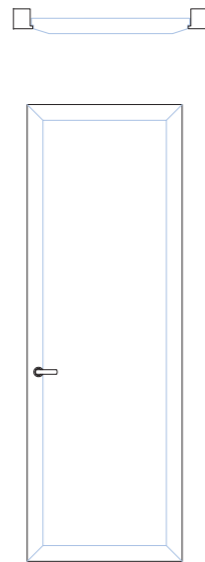

L
luce netta / opening width
700-900 mm 27 1/2" - 35 3/8"

H
altezza netta / opening height
max 3000 mm 118 1/4"

L1
vano muro / rough opening
L + 100 mm

H1
vano muro / rough opening
H + 50 mm

EL
ingombro totale / overall sizes
L + 28 mm

EH
ingombro totale / overall sizes
H + 14 mm

Raso USA

Anta a battente in tamburato spessore mm 55. Finitura del battente grezzo con una mano di fondo; laccato opaco e laccato lucido nei colori di serie o essenze. Stipite in alluminio a vista, spessore 13 mm, nelle diverse finiture di serie. Non necessita di falso telaio. Guarnizioni di battuta. Cerniere a scomparsa regolabile.

Hinged door in mm 55 thick hollow-core. Door panel finished with a base coat, matt or gloss lacquered in the standard colors or veneered. Visible, mm 13 thick aluminium jamb in a variety of standard finishes. No frame needed. Striker seals. Adjustable concealed hinges.

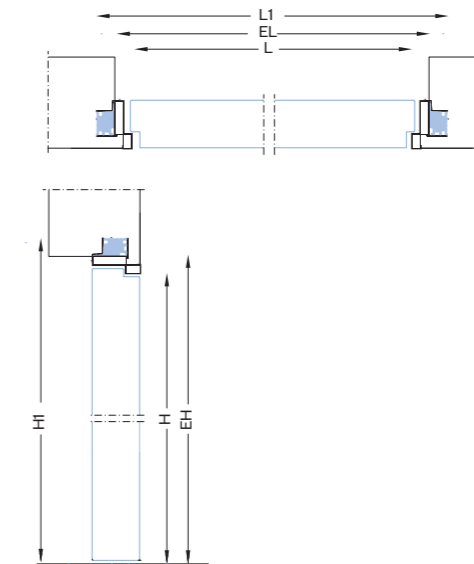

Raso USA spingere / Push opening

L
luce netta / opening width
700-900 mm 27 1/2" - 35 3/8"

H
altezza netta / opening height
max 3000 mm 118 1/4"

L1
vano muro / rough opening
L + 126 mm

H1
vano muro / rough opening
H + 63 mm

EL
ingombro totale / overall sizes
L + 48 mm

EH
ingombro totale / overall sizes
H + 24 mm

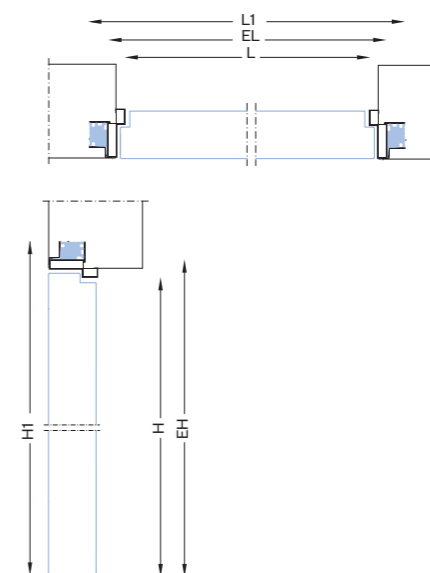

Raso USA tirare / Pull opening

L
luce netta / opening width
700-900 mm 27 1/2" - 35 3/8"

H
altezza netta / opening height
max 3000 mm 118 1/4"

L1
vano muro / rough opening
L + 126 mm

H1
vano muro / rough opening
H + 63 mm

EL
ingombro totale / overall sizes
L + 48 mm

EH
ingombro totale / overall sizes
H + 24 mm

Compass 55

Porta a bilico con anta a struttura tamburata di spessore 55 mm.
 Finitura del battente: grezzo con mano di fondo, laccato lucido o opaco nei colori di serie, impiallacciato verticalmente in essenze di serie.
 Impiallacciatura orizzontale solo su richiesta. Telaio-stipite in alluminio anodizzato preassemblato da murare. Non necessita di falso telaio.
 Guarnizioni di battuta.

Pivoting door, mm 55 thick with hollow-core structure.
 Door panel: unfinished with a primer coat, gloss or matt lacquered from the standard color range, vertical veneers from the standard range.
 Horizontal veneer on request.
 Jamb and frame in pre-assembled anodized aluminium for direct wall installation. Subframe not necessary.
 Door striker seal.

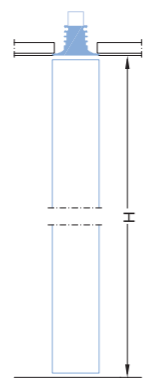
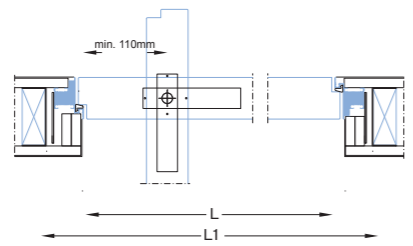
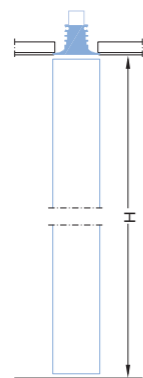
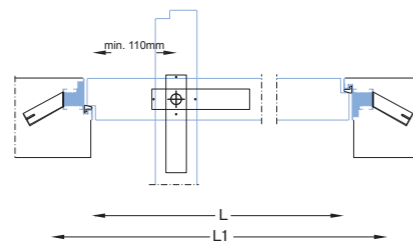

Versione per muratura / Brickwall

L
 luce netta / opening width
 700-900 mm 27 1/2" - 35 3/8"

H
 altezza netta / opening height
 max 3000 mm 118 1/4"

L1
 vano muro / rough opening
 L + 100 mm

H1
 vano muro / rough opening
 H + 53 mm

Versione per cartongesso / Drywall

L
 luce netta / opening width
 700-900 mm 27 1/2" - 35 3/8"

H
 altezza netta / opening height
 max 3000 mm 118 1/4"

L1
 vano muro / rough opening
 L + 100 mm

H1
 vano muro / rough opening
 H + 53 mm

Compass 55 senza battuta

Porta a bilico con anta a struttura tamburata di spessore 55 mm.
 Finitura del battente: grezzo con mano di fondo, laccato lucido o opaco nei colori di serie, impiallacciato verticalmente in essenze di serie.
 Impiallacciatura orizzontale solo su richiesta. Traverso in alluminio anodizzato preassemblato da murare. Non necessita di falso telaio.
 Guarnizioni di battuta.

Pivoting door, mm 55 thick, with hollow-core structure. Door panel: unfinished with a primer coat, gloss or matt lacquered from the standard color range, vertical veneers from the standard range.
 Horizontal veneer on request.
 Header in pre-assembled anodized aluminium for direct wall installation. Subframe not necessary.
 Door striker seal.

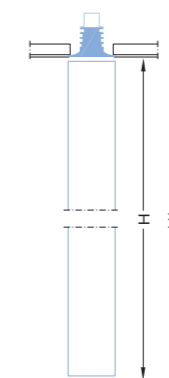
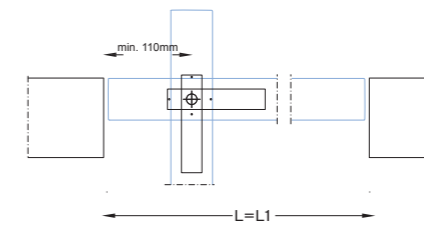

L
 luce netta / opening width
 700-900 mm 27 1/2" - 35 3/8"

H
 altezza netta / opening height
 max 3000 mm 118 1/4"

L1
 vano muro / rough opening
 L1 = L

H1
 vano muro / rough opening
 H + 53 mm

Scorrevole a scomparsa senza stipite

Porta con anta a struttura tamburata di spessore 41 mm a lavorazione ultimata con finitura laccato opaco, lucido, essenze oppure con telaio perimetrale in alluminio e lastre di vetro. Maniglia ad incasso. Montaggio su cassaporta metallica.

Sliding-pocket without jamb. mm 41 (1 3/4") thick hinged door with hollow-core structure. Finishes available in matt or gloss lacquer or in glass with frame in aluminium. Flush handle. Installation requires a steel frame for stud wall.

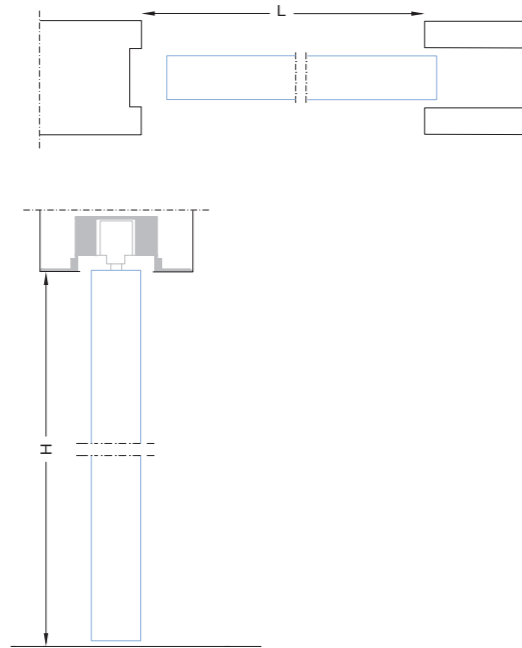

L
luce netta / opening width
600-900 mm 23 5/8" - 35 3/8"
H
altezza netta / opening height
max 2900 mm 114 1/4"

Super

Porta a battente in tamburato, spessore 41 mm. Bordi a sezione arrotondata. Battente laccato lucido al poliestere nei colori di serie, laccato opaco e in essenze. Stipite in alluminio laccato opaco. Feltrino di battuta. Reversibilità del senso di apertura. Cerniere a scomparsa. Montaggio su falsi telai in lamiera verniciata.

Hollow-core hinged door, mm 41 thick, with hollow-core structure. Rounded edges. Gloss or matt lacquered from the standard range of colours, or veneered. Jamb in matt lacquered aluminum. Jamb thickness mm 100, 110 and 125. Felt striker. Reversible opening. Concealed hinges. Mounted on subframe with painted sheet metal.

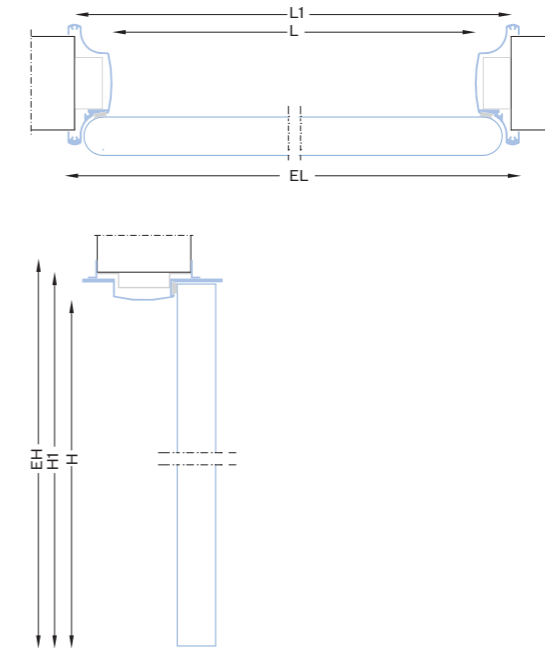

L
luce netta / opening width
600-900 mm 23 5/8" - 35 3/8"
H
altezza netta / opening height
max 2900 mm 114 1/4"
L1
vano muro / rough opening
L + 80 mm
H1
vano muro / rough opening
H + 30 mm
EL
ingombro totale / overall sizes
L + 96 mm
EH
ingombro totale / overall sizes
H + 45 mm

L41

Porta con battente a struttura tamburata di spessore 41 mm a lavorazione ultimata, con finitura laccato opaco, lucido ed essenze di serie; oppure con battente con telaio perimetrale in alluminio e lastre di vetro. Stipite in alluminio in diverse finiture. Guarnizioni di battuta. Cerniere a scomparsa. Montaggio su falso telaio dedicato.

Hinged door with a hollow core structure, mm 41 (1 3/4") thick. Finished in matt or gloss lacquer or with a veneer from the standard range. Jamb in aluminium in a choice of finishes. Striker seal. Concealed hinges. Installation requires a subframe.

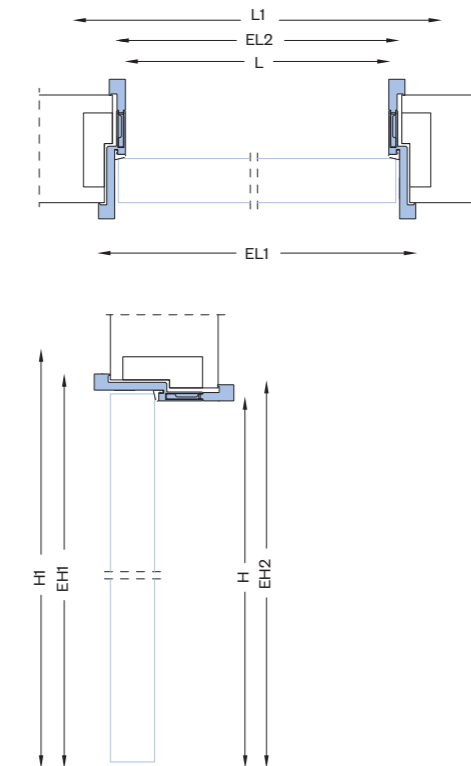

L
luce netta / opening width
600-900 mm 23 5/8" - 35 3/8"

H
altezza netta / opening height
max 3000 mm 118 1/4"

L1
vano muro / rough opening
L + 100 mm

H1
vano muro / rough opening
H + 50 mm

EL1
ingombro totale / overall sizes
L + 53 mm

EH1
ingombro totale / overall sizes
H + 27 mm

EL2
ingombro totale / overall sizes
L + 28 mm

EH2
ingombro totale / overall sizes
H + 15 mm

L41 scorrevole a scomparsa

Porta con anta a struttura tamburata di spessore 41 mm a lavorazione ultimata con finitura laccato opaco, lucido, essenze oppure con telaio perimetrale in alluminio e lastre di vetro. Stipite in alluminio in diverse finiture. Maniglia ad incasso. Montaggio su cassaporta metallica.

L41 Sliding-pocket door, mm 41 (1 3/4") thick, with hollow-core structure. Available matt or gloss lacquered, or with a wood veneer. Glass door version features aluminium edging. Jamb in aluminium in a choice of finishes. Flush handle. Installation requires a steel frame for stud wall.

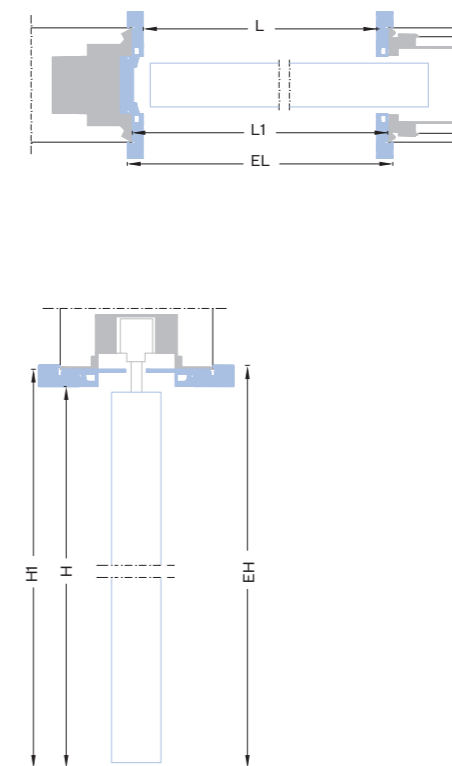

L
misure effettive / clear opening
L1 - 23 mm

H
misure effettive / clear opening
H1 - 12 mm

L1
misure nominale / nominal opening
600-900 mm 23 5/8" - 35 3/8"

H1
misure nominale / nominal opening
max 3000 mm 118 1/4"

EL
ingombro totale / overall sizes
L + 30 mm

EH
ingombro totale / overall sizes
H + 15 mm

Outline

Porta a battente in tamburato da 45 mm. Bordi a sezione squadrata. Battente in laccato lucido e laccato opaco o essenze. Telaio in alluminio per installazione diretta sulla parete. Cerniere pivotanti in acciaio. Guarnizione di battuta. Montaggio su vano muro presquadrato. Serratura orizzontale.

Hollow core hinged door, mm 45 thick. Squared edges. Gloss or matt lacquered or wood veneer. Aluminium frame for direct wall installation. Pivoting steel hinges. Door striker seal. Installation on pre-squared wall. Horizontal lock.

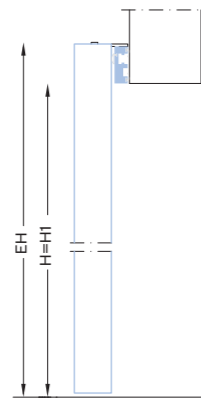
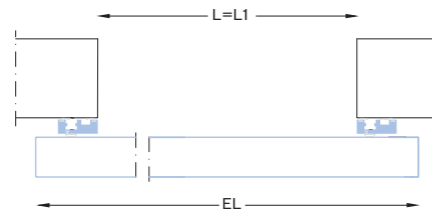

L
luce netta / opening width
700-900 mm 27 1/2"- 35 3/8"

H
altezza netta / opening height
max 3000 mm 118 1/4"

L1
vano muro / rough opening
L1 = L

H1
vano muro / rough opening
H1 = H

EL
ingombro totale / overall sizes
L + 140 mm

EH
ingombro totale / overall sizes
H + 48 mm

Drive

Porta scorrevole in tamburato da 41 mm. Bordi a sezione quadrata. Finiture dell'anta: essenze o laccato lucido e opaco nei colori di serie. Carrello a parete e rotelle di scorrimento a pavimento. Montaggio su muro presquadrato.

Hollow-core sliding door, mm 41 thick. Squared edges. Finishes: veneered, or gloss or matt lacquered from the standard color range. Wall hanger trolley and floor rollers. Installation on pre-squared wall.

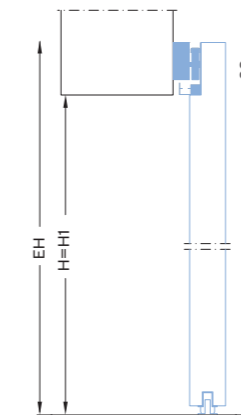
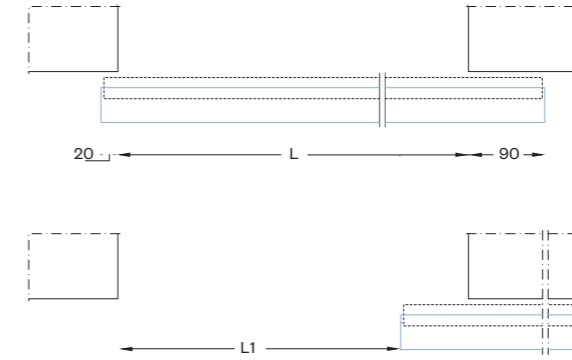

L
luce netta / opening width
700-900 mm 27 1/2"- 35 3/8"

H
altezza netta / opening height
max 3000 mm 118 1/4"

L1
luce passaggio / clear opening
L - 80 mm

EL
ingombro totale / overall sizes
L + 110 mm

EH
ingombro totale / overall sizes
H + 60 mm

Filo 55 s-t

Porta a battente in tamburato, spessore 55 mm. Finitura in laccato opaco o lucido o essenze. Sistema telescopico dello stipite da 105 a 130 mm. Guarnizione di battuta. Cerniere a scomparsa. Montaggio su falsi telai tradizionali in legno. Disponibile versione scorrevole.

Hollow-core hinged door, thickness mm 55. Finished in matt or gloss lacquer from the standard color range or veneered. Jamb adjustable from mm 105 to 130. Door striker seal. Concealed hinges. Mounted on traditional wood subframe. Available as sliding door.

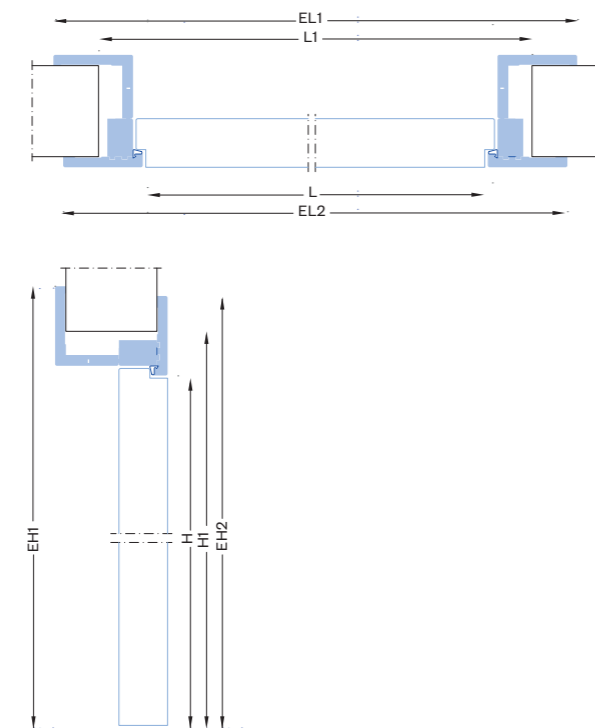

Filo s apertura a spingere / Push opening

L luce netta / opening width 600-900 mm 23 5/8" - 35 3/8"
H altezza netta / opening height max 2900 mm 114 1/4"
L1 vano muro / rough opening L + 100 mm
H1 vano muro / rough opening H + 50 mm
EL1 ingombro totale / overall sizes L + 203 mm
EH1 ingombro totale / overall sizes H + 101 mm
EL2 ingombro totale / overall sizes L + 181 mm
EH2 ingombro totale / overall sizes H + 90 mm

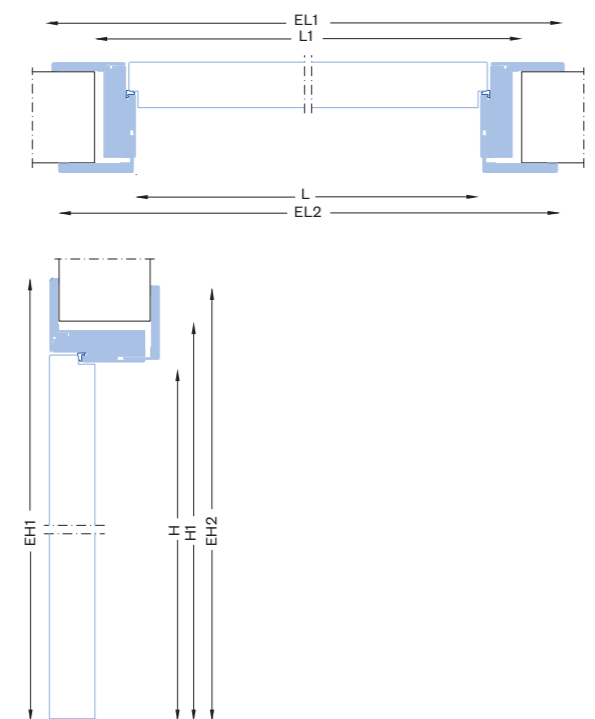

Filo t apertura a tirare / Pull opening

L luce netta / opening width 600-900 mm 23 5/8" - 35 3/8"
H altezza netta / opening height max 2900 mm 114 1/4"
L1 vano muro / rough opening L + 100 mm
H1 vano muro / rough opening H + 50 mm
EL1 ingombro totale / overall sizes L + 203 mm
EH1 ingombro totale / overall sizes H + 102 mm
EL2 ingombro totale / overall sizes L + 185 mm
EH2 ingombro totale / overall sizes H + 93 mm

Lcd62

Porta a battente in tamburato, spessore 41 mm. Finitura in laccato opaco o lucido o essenze. Sistema telescopico dello stipite da 105 a 130 mm. Guarnizione di battuta. Reversibilità del senso di apertura. Cerniere a scomparsa. Montaggioso falsi telai tradizionali in legno. Disponibile anche in versione scorrevole esterna o a scomparsa.

Hollow-core hinged door, thickness mm 41. Finished in matt or gloss lacquer from the standard color range, or veneered. Jamb adjustable from mm 105 to 130. Door striker seal. Reversible opening. Concealed hinges. Mounted on traditional wood subframe. Also available in pocket and surface mounted sliding versions.

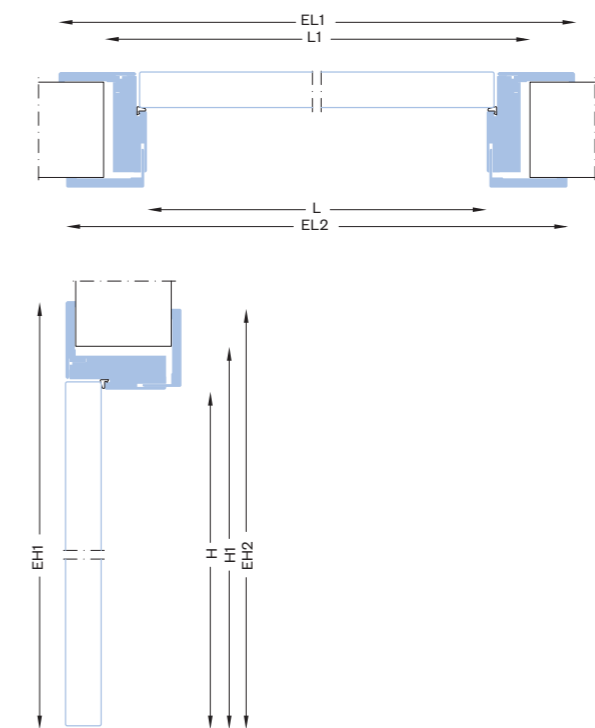

L luce netta / opening width 600-900 mm 23 5/8" - 35 3/8"
H altezza netta / opening height max 2900 mm 114 1/4"
L1 vano muro / rough opening L + 100 mm
H1 vano muro / rough opening H + 50 mm
EL1 ingombro totale / overall sizes L + 203 mm
EH1 ingombro totale / overall sizes H + 102 mm
EL2 ingombro totale / overall sizes L + 185 mm
EH2 ingombro totale / overall sizes H + 93 mm

Avenue

Porta a battente tamburato spessore 41 mm con specchiature incassate a uno, due o tre riquadri. Battente e stipite laccati opaco nei colori di serie, stipite telescopico, guarnizioni di battuta e cerniere a scomparsa. Sistema telescopico dello stipite da 110 a 135 mm. Disponibile in versione scorrevole.

Hollow-core hinged door mm 41 thick with one, two or three recessed panels. Door panel and jamb in a matt finish from the standard color range, telescopic jamb, door striker seal and concealed hinges. Jamb adjustable from mm 110 to 135. Available also as sliding door.

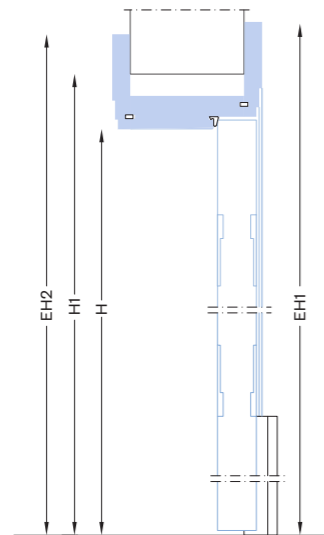
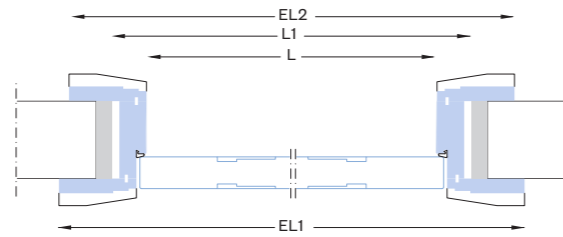

- L**
luce netta / opening width
600-900 mm 23 5/8" - 35 3/8"
- H**
altezza netta / opening height
max 2900 mm 114 1/4"
- L1**
vano muro / rough opening
L + 100 mm
- H1**
vano muro / rough opening
H + 50 mm
- EL1**
ingombro totale / overall sizes
L + 224 mm
- EH1**
ingombro totale / overall sizes
H + 112 mm
- EL2**
ingombro totale / overall sizes
L + 207 mm
- EH2**
ingombro totale / overall sizes
H + 103 mm

San Siro

Porta a battente in tamburato, spessore 41 mm, con specchiature incassate. Battente e stipite laccato opaco nei colori di serie. Sistema telescopico dello stipite da 105 a 130 mm. Guarnizione di battuta. Reversibilità del senso di apertura. Cerniere a scomparsa. Montaggio su falsi telai tradizionali in legno. Disponibile anche in versione scorrevole esterna o a scomparsa.

Hollow-core hinged door, mm 41 thick, with recessed panels. Door panel and jamb in a matt finish from the standard color range. Telescopic jamb from mm 105 to 130. Door striker seal. Reversible opening. Concealed hinges. Mounted on traditional wooden subframe. Pocket or external sliding versions also available.

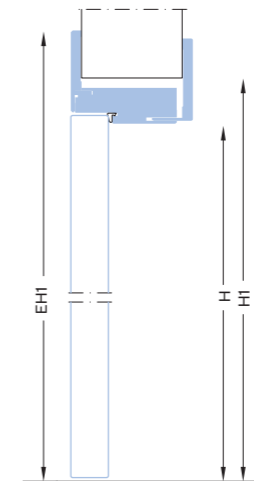

- L**
luce netta / opening width
600-900 mm 23 5/8" - 35 3/8"
- H**
altezza netta / opening height
max 2900 mm 114 1/4"
- L1**
vano muro / rough opening
L + 100 mm
- H1**
vano muro / rough opening
H + 50 mm
- EL1**
ingombro totale / overall sizes
L + 203 mm
- EH1**
ingombro totale / overall sizes
H + 102 mm
- EL2**
ingombro totale / overall sizes
L + 185 mm
- EH2**
ingombro totale / overall sizes
H + 93 mm

Matrix

Battenti e scorrevoli: pannello in legno massello composto da tre diversi rilievi - A, B e C - accostati come da configurazione. Applicabile, solo a un lato, a: Rasomuro 55s, Compass 55 e ante scorrevoli con 50 mm di spessore.

Boiserie: pannello in legno massello disponibile con un solo rilievo a scelta tra A, B o C.

Hinged and sliding doors: solid wood panel composed of three different reliefs - A, B and C - as illustrated. Applicable on one side only to:

Rasomuro 55s, Compass 55 and mm 50 thick sliding doors.

Boiserie: solid wood panel available in one relief only - A, B, or C.

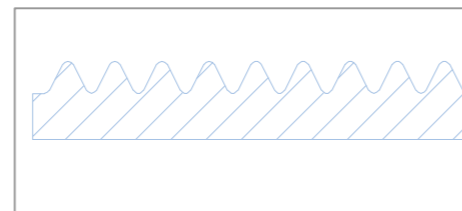
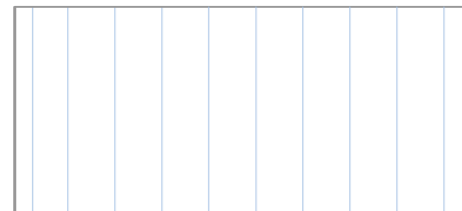

Tipo A / Type A

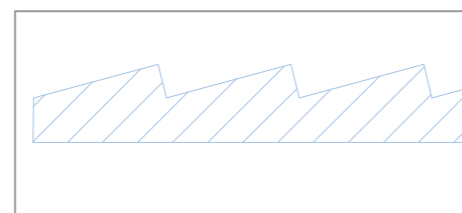

Tipo B / Type B

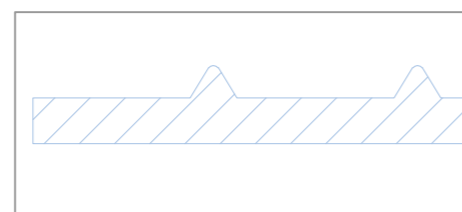

Tipo C / Type C

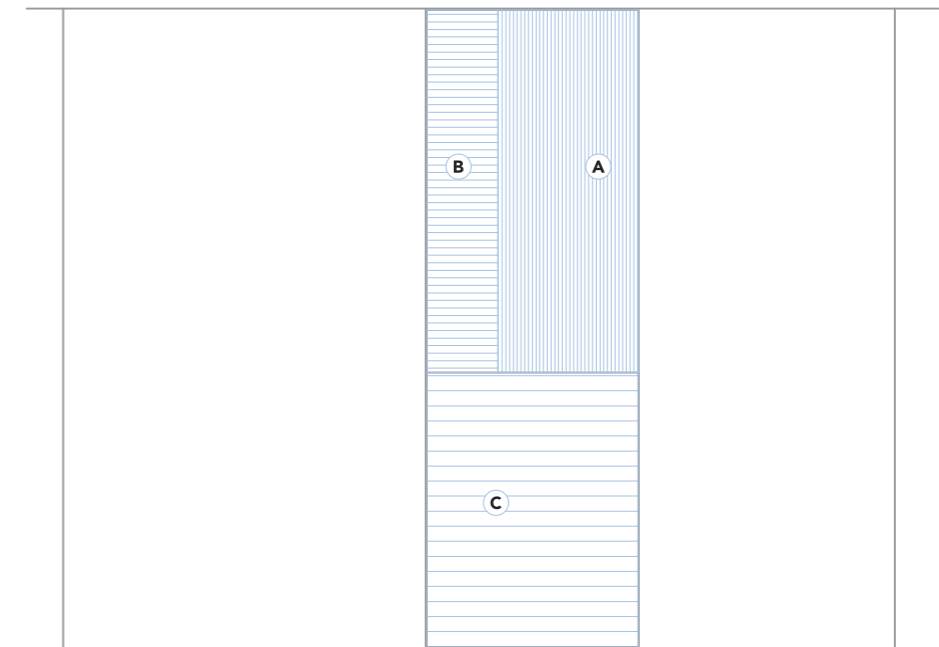

Configurazione Matrix per Rasomuro 55s / Compass 55 / Matrix layout for Rasomuro 55s / Compass 55

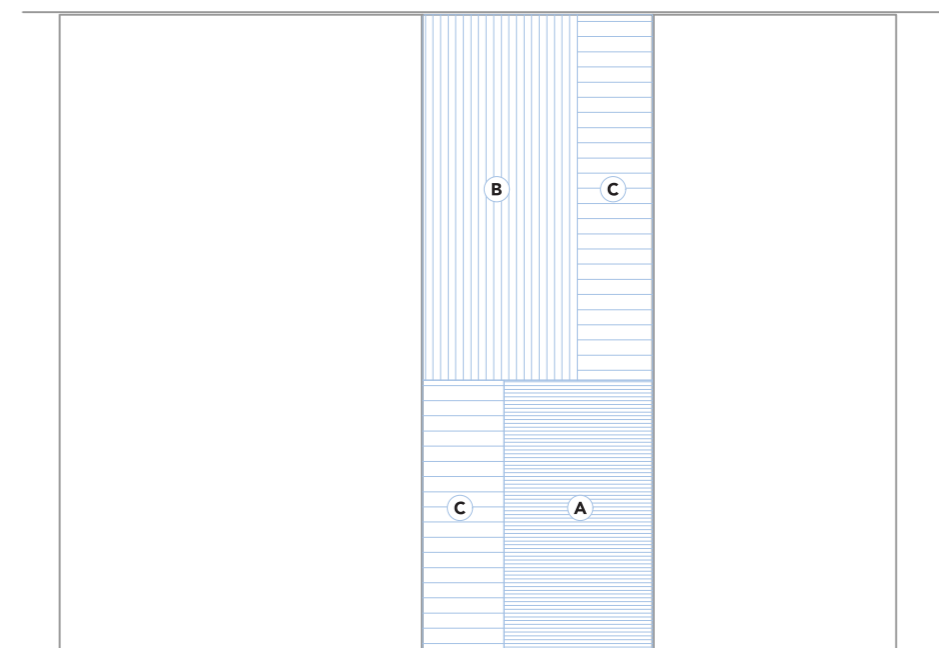

Configurazione Matrix per anta scorrevole / Matrix layout for sliding doors

Maniglie
Handles

Push&Pull



A



B



B - B1



C



D

A
Maniglia Push&Pull /
cromo satinato /
Push&Pull handle
satin chrome

B - B1
Nottolino Push&Pull /
Push&Pull privacy lock

C
Bocchetta yale /
Yale escutcheon

D
Bocchetta patent /
Patent escutcheon

Lualdi



A



B



B - B1



C



D

A
Maniglia Lualdi
cromo satinato /
Lualdi handle
satin chrome

B - B1
Nottolino Lualdi /
Lualdi privacy lock

C
Bocchetta yale /
Yale escutcheon

D
Bocchetta patent /
Patent escutcheon

Maniglie
Handles

Martina



A



B



B - B1



C



D

A
Maniglia Martina
cromo satinato /
Martina handle
satin chrome

B - B1
Nottolino Martina /
Martina privacy lock

C
Bocchetta yale /
Yale escutcheon

D
Bocchetta patent /
Patent escutcheon

Outline



A



B



B - B1



C



D

A
Maniglia Outline
cromo satinato /
Outline handle
satin chrome

B - B1
Nottolino Outline /
Outline privacy lock

C
Bocchetta yale /
Yale escutcheon

D
Bocchetta patent /
Patent escutcheon

**Maniglie
Handles**

Edge



A



B



B - B1



C



D

A
Maniglia Edge
cromo satinato /
Edge handle
satin chrome

B - B1
Nottolino Edge /
Edge privacy lock

C
Bocchetta yale /
Yale escutcheon

D
Bocchetta patent /
Patent escutcheon

Ishi



A



B



B - B1



C



D

A
Maniglia Ishi
cromo satinato, alluminio,
bronzo, nero, bianco /
Ishi handle
satin chrome, aluminum,
bronze, black, white

B - B1
Nottolino Ishi /
Ishi privacy lock

C
Bocchetta yale /
Yale escutcheon

D
Bocchetta patent /
Patent escutcheon

**Maniglie per porte scorrevoli
Handles for sliding doors**

Ishi



A



B

A
Maniglia Ishi ad incasso
cromo satinato, alluminio,
bronzo, nero, bianco /
Ishi flush handle
satin chrome, aluminum,
bronze, black, white

B
Nottolino Ishi /
Ishi privacy lock

cnq



A



B

A
Maniglia cnt ad incasso
cromo satinato /
cnq flush handle
satin chrome

B
Nottolino cnt /
cnt privacy lock

cnt



A



B

A
Maniglia cnq ad incasso
cromo satinato /
cnq flush handle
satin chrome

B
Nottolino cnq /
cnq privacy lock

L7



A

A
Maniglia L7
cromo satinato, alluminio,
bronzo, nero, bianco /
L7 handle
satin chrome, aluminum,
bronze, black, white

Shoin



A

A
Maniglia Shoin
cromo satinato, alluminio,
bronzo, nero, bianco /
Shoin handle
satin chrome, aluminum,
bronze, black, white

**Maniglia Pomm
Pomm handle**



A
Alluminio /
Aluminum



B
Nero opaco /
Matt black



C
Bronzo /
Bronze



D
Bianco opaco /
Matt white

**Vetri
Glasses**

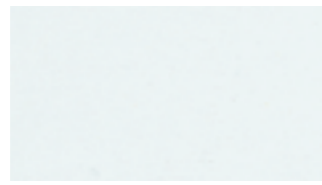

Trasparente extrachiaro
Transparent extraclear

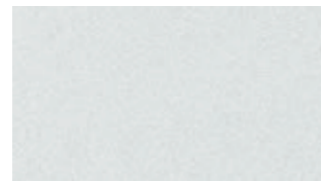

Satinato extrachiaro
Satin extraclear



Extrachiaro riflettente
Reflective extraclear



Grigio trasparente
Transparent grey



Grigio satinato
Satin grey



Grigio riflettente
Reflective grey



Bronzo trasparente
Transparent bronze



Bronzo satinato
Satin bronze



Bronzo riflettente
Reflective bronze

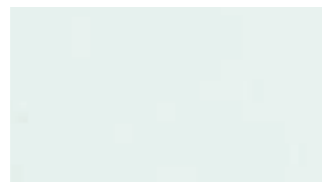

Extrachiaro opalino
Opalin extraclear



Stratificato specchio
Laminated mirror

**Vetri speciali
Special glasses**



Flutes extra chiaro trasparente
Transparent extraclear fluted



Flutes grigio trasparente
Grey transparent fluted



Ornament extrachiaro trasparente
Transparent extraclear ornament

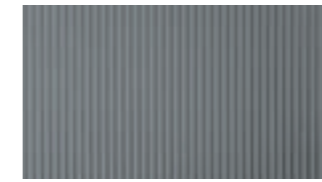

Ornament grigio trasparente
Grey transparent ornament



Masterpoint
Masterpoint

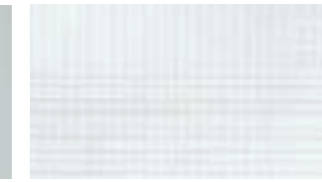

Marks extrachiaro
Marks extraclear



Marks extrachiaro satinato
Marks satin extraclear



Retina metallica damier
Metallic damier mesh

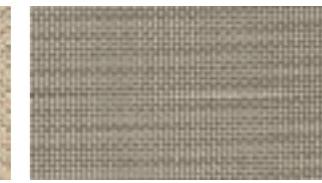

Retina bronzo
Bronze mesh

**Vetri retrolaccati
Backpainted glasses**

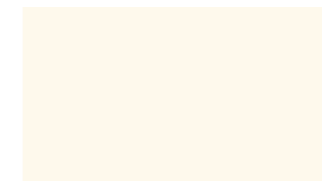

Bianco ottico
Pure white

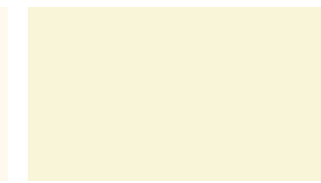

Bianco gesso
Chalk white



Avorio
Ivory



Grigio calce
Lime grey



Grigio tortora
Dove grey



Terra
Clay



Grigio ferro
Iron grey

Profili
Profiles



Alluminio naturale
Natural aluminium



Brill spazzolato
Brushed brill



Nero opaco
Matt black



Bronzo
Bronze

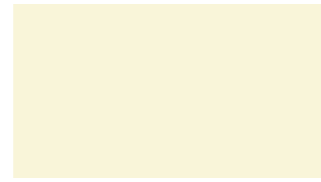

Bianco opaco
Matt white

Legni
Woods



Rovere naturale
Natural oak

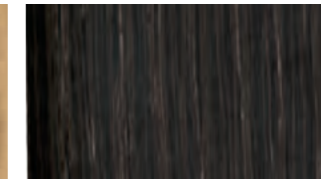

Rovere moka
Moka oak



Rovere thermowood
Thermowood oak



Rovere grigio
Grey oak



Rovere nero fossile
Black fossil oak



Noce canaletto
Canaletto walnut

Colori laccato opaco/lucido
Matt/gloss lacquered finish

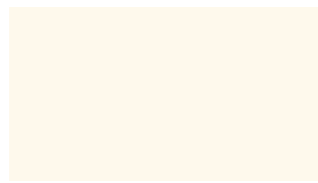

Bianco ottico
Pure white

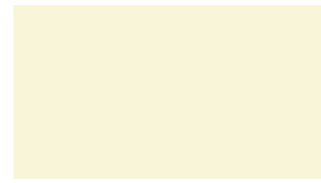

Bianco gesso
Chalk white



Avorio
Ivory



Grigio calce
Lime grey



Grigio tortora
Dove grey



Terra
Clay



Grigio ferro
Iron grey

Lualdi Spa
Via Kennedy
20010 Marcallo con Casone (MI)
T. +39 02 94363000
www.lualdi.com
info@lualdi.com

Showroom
Milano
Foro Buonaparte 74
20121 Milano
T. +39 02 8052445
showroom@lualdi.com

Miami
Lualdi Inc.
318 NE 80th Terrace North
FL 33138
T. +1 305 576 4333
infomiami@lualdi.us

New York
584 Broadway, suite 1005.
New York, NY 10012
T. +1 212 334 4544
infony@lualdi.us

a.d. Graph.X
foto Giuseppe Brancato
styling Carin Scheve,
Alessandra Salaris
testi Giovanna Zoboli,
Patrizia Scarzella
traduzioni Richard Peace

retouching, pre press A. De Pedrini
stampa Nava Press 2019

I colori e le finiture, le illustrazioni
e le descrizioni del presente
catalogo sono a titolo indicativo.
Lualdi spa si riserva il diritto di
apportare, anche senza preavviso,
modifiche di carattere tecnico
e produttivo.

The colours, finishes, illustrations
and descriptions in this catalogue
are provided solely by way
of example. Lualdi spa reserves
the right to make technical
and design changes without
prior notice.

Thanks to:
Abc Italia
Almerich
Alizarina-Studio
Amaaro!
Amini
Anvia
Artek
Aytm
Baxter
Bross Italia
Carl Hansen & Søn
Carré D'artistes Milano
CC-tapis
Co.arch Studio
Colè Gallery
Desalto
Draga & Aurel
Edizioni Design
Fabbian
Fantini Rubinetti
Flos
Fontana Arte
Francesca Verardo
Gallotti & Radice
Golran
Gt Design
Guaxs
Hk Living
Ilaria Innocenti
Inkiostro Bianco
Karpeta
Kristina Dam
La Cividina
Lema
Les Ottomans
Living Divani
Loloey
London Art
Luceplan
Mani Ceramics
Marca Corona
Menu
Meridiani
Midinette
Milano Parquet
Miniforms
MM Lampadari
My Home Collection
Nahoor
Nemo
Niki Jones
Paola Zani
Penta
Pietro Russo
Poliform
Porada
Porro
Potocco
Presotto
Pulpo
Restart
Roberta Licini
Rosenthal
San Giacomo
Sans Tabù
Servomuto
Shuj
Texturae
Venicem
Vetriere di Empoli
Vito Nesta per Les Ottomans
Vitra
Zanotta

