



CASAMANIA  
HORM

---

# Contenitori, Mensole e Librerie

---

## Awards



COMPASSO D'ORO

2008 / Stand Salone 2005  
2004 / Ripples  
1998 / Istruzioni di montaggio



MENZIONE D'ONORE

2016 / Autoreggente  
2011 / Bek  
2008 / Tide

2001 / Sottiletto  
1998 / Wow! Plus  
1998 / Take

1994 / Tola



GOOD DESIGN

2014 / Autoreggente  
2013 / Infinity  
2011 / RememberMe

2008 / N7



iF INTERIOR INNOVATION

2014 / Toshi  
2013 / Lepel  
2013 / Chariot



reddot

2016 / QuaDror™ 03



iF DESIGN AWARD

2012 / Maritime

archiproducts DESIGN AWARDS 2<sup>nd</sup> PRIZE

2016 / Tout le Jour



archiproducts DESIGN AWARDS SPECIAL MENTION

2016 / Torii



YOUNG DESIGN

2010 / Lieve  
2007 / A/R



DESIGN INDEX ADI

2016 / Torii  
2015 / Autoreggente  
2013 / Chariot  
2011 / Sinapsi

2008 / Bek  
2008 / A/R  
2007 / Blend  
2007 / Tide

2006 / Stand Salone 2005  
2004 / Ripples  
1999 / Sottiletto

## Home &amp; Contract

Gli opposti si attraggono. HORM e CASAMANIA hanno da sempre due anime distinte, intrise di pura passione per la ricerca, la qualità, il design. Questo Catalogo rappresenta l'inizio di un progetto: far dialogare questi pluridecennali campioni del Made in Italy, nel solco della loro identità. Horm è lo stile più rigoroso, formale, elegante, caratterizzato dal sapiente uso delle materie pure come il legno, la pietra, il marmo, il vetro. Casamania gioca da sempre con l'ironia, l'irriverenza formale, la voglia di rompere gli schemi nel segno della funzionalità e della ricerca. La prima è sempre stata e continuerà ad essere un'icona di stile e di raffinata eleganza in ambito HOME; la seconda è un modello per il mercato CONTRACT. Tuttavia gli opposti si attraggono, si fondono e si moltiplicano, offrendo infinite soluzioni di stile, di utilizzo, di collocazione. Due identità che unite vogliono rompere le rigide barriere del mercato, ponendo al centro del progetto l'Uomo nelle sue molteplici attività: pensare, sedersi, riposare, mangiare, lavorare, studiare, giocare, dormire, amare, sognare, conversare. Horm e Casamania: Home & Contract.

Vol. 01  
Sedute, Tavoli e Tavolini

Vol. 02  
Contenitori, Mensole e Librerie

Vol. 03  
Complementi, Illuminazione e Outdoor

Vol. 04  
Letti, Divani Letto e Isole Figi

Vol. 05  
Divani

Opposites attract. HORM and CASAMANIA have always had two different souls, imbued with a pure passion for research, quality and design. This catalogue represents the starting point of a new project: to make these historical champions of the Made in Italy production talk to each other, in the wake of their identity. Horm is the most rigorous, formal, elegant style, characterised by the skilful use of pure materials, such as wood, stone, marble and glass. Casamania has always played with irony, formal irreverence, the desire to break the mould in the name of functionality and research. The first has always been and will continue being an icon of style and refined elegance in the HOME, the second a model for the CONTRACT market. However, opposites attract, merge and multiply, offering infinite solutions of style, use and arrangement. Two identities that together want to break the rigid barriers of the market, placing People in its many activities at the heart of the project: thinking, sitting, resting, eating, working, studying, playing, sleeping, loving, dreaming, talking. Horm and Casamania: Home & Contract.

Vol. 01  
Chairs, Tables, and Low Tables

Vol. 02  
Storage and Shelving Solutions

Vol. 03  
Furnishing Accessories,  
Lighting, and Outdoor

Vol. 04  
Beds, Sofa Beds, and Figi Islands

Vol. 05  
Sofas and Armchairs

Les opposés s'attirent. HORM et CASAMANIA ont toujours eu deux âmes distinctes, imprégnées d'une pure passion pour la recherche, la qualité et le design. Ce catalogue représente le début d'un projet: faire dialoguer ces pluridécennales champions du Made in Italy, dans la lignée de leur identité. Horm représente un style plus rigoureux, formel, élégant, caractérisé par une utilisation habile des matériaux purs comme le bois, la pierre, le marbre et le verre. Casamania a toujours joué avec l'ironie, l'irrévérence formelle, le désir de briser les schémas sous le signe de la fonctionnalité et de la recherche. La première a toujours été et continuera à être une icône de style et d'élégance raffinée dans le domaine HOME, la seconde est un modèle pour le marché CONTRACT. Cependant, les opposés s'attirent, fusionnent et se multiplient, en offrant des solutions infinies de style, d'utilisation et d'emplacement. Deux identités qui, ensemble, veulent briser les rigides barrières du marché, en plaçant l'Homme dans ses nombreuses activités au centre du projet: penser, s'asseoir, se reposer, manger, travailler, étudier, jouer, dormir, aimer, rêver, converser. Horm et Casamania: Home & Contract.

Vol. 01  
Chaises, Tables et Tables Basses

Vol. 02  
Meubles de rangement, Étagères et Bibliothèques

Vol. 03  
Compléments d'ameublement,  
Luminaire et Outdoor

Vol. 04  
Lits, Canapés-lits et Îles Figi

Vol. 05  
Canapés et Fauteuils

Gegensätze ziehen sich an. HORM und CASAMANIA hatten schon immer zwei verschiedene Seelen, durchdrungen von einer reinen Leidenschaft für Forschung, Qualität und Design. Dieser Katalog stellt den Beginn eines Projekts dar: diese jahrzehntelangen Meister des Made in Italy im Zuge ihrer Identität miteinander in Dialog zu bringen. Horm ist der rigoroseste, formalste und eleganteste Stil, der sich durch den geschickten Einsatz von reinen Materialien wie Holz, Stein, Marmor und Glas auszeichnet. Casamania setzte schon immer auf Ironie, formale Respektlosigkeit und den Wunsch, diese Klischees im Namen der Funktionalität und Forschung durchzubrechen. Die erste war und ist eine Ikone des Stils und der raffinierten Eleganz im Bereich HOME, die zweite ein Modell für den CONTRACT-Markt. Gegensätze ziehen sich jedoch an, verschmelzen und multiplizieren sich und bieten unendliche Lösungen für Stil, Nutzung und Anordnung. Zwei Identitäten, die gemeinsam die starren Barrieren des Marktes überwinden wollen, indem sie den Menschen in den Mittelpunkt des Projekts stellen: Denken, Sitzen, Ausruhen, Essen, Arbeiten, Studieren, Spielen, Schlafen, Lieben, Träumen, Sprechen. Horm und Casamania: Home & Contract.

Vol. 01  
Stühle, Tische, Couch- und Beistelltische

Vol. 02  
Sideboards, Wandregale und Bücherregale

Vol. 03  
Kleinformöbel, Accessoires,  
Lampen und Outdoor

Vol. 04  
Betten, Bettsofas und Figi-Inseln

Vol. 05  
Sofas und Sessel

Los opuestos se atraen. HORM y CASAMANIA siempre han tenido dos almas distintas, imbuidas de pura pasión por la investigación, la calidad y el diseño. Este catálogo representa el comienzo de un proyecto: un diálogo entre estos campeones del Made in Italy, partiendo de la identidad de cada uno de ellos. Horm es el estilo más riguroso, formal y elegante, caracterizado por un uso hábil de materiales puros como la madera, la piedra, el mármol y el vidrio. Casamania siempre ha jugado con la ironía, la irreverencia formal, el deseo de romper moldes en aras de la funcionalidad y la investigación. La primera ha sido siempre y lo seguirá siendo un icono de estilo y refinada elegancia en el ámbito HOME, la segunda es un referente del mercado CONTRACT. Sin embargo, los opuestos se atraen, se fusionan y se multiplican, aportando infinitas soluciones de estilo, uso y ubicación. Dos identidades que quieren romper juntas las rígidas barreras del mercado, colocando en el centro del proyecto al Ser Humano en sus múltiples actividades: pensar, sentarse, descansar, comer, trabajar, estudiar, jugar, dormir, amar, soñar, conversar. Horm y Casamania: Home & Contract.

Vol. 01  
Sillas, Mesas y Mesitas

Vol. 02  
Aparadores, Estanterías y Librerías

Vol. 03  
Complementos de decoración,  
Iluminación y Outdoor

Vol. 04  
Camas, Sofás Cama e Islas Figi

Vol. 05  
Sofás y Sillones

# Designers



Baldanzi  
& Novelli



Claudio  
Bellini



Mario  
Bellini



Patrizia  
Bertolini



Mario  
Botta



Burtcher  
& Bertolini



Enrico  
Cesana



Claesson  
Koivisto  
Rune



Carlo  
Cumini



Maarten  
De Ceulaer



Joe  
Doucet



Dror



D'Urbino  
Lomazzi



Sebastian  
Errazuriz



Fabrica



GamFratesi



Daniele  
Gaspardo



Jean Francois  
Gornée



Grafite  
Design



Harry  
& Camila



Steven  
Holl



Benjamin  
Hubert



Giulio  
Iacchetti



Salvatore  
Indriolo



Toyo  
Ito



Tobias  
Jurczek



LucidiPevere



Giulio  
Manzoni



Ilaria  
Marelli



Menguzzato  
& Nascimben



Neuland,  
Paster &  
Geldmacher



Luca  
Nichetto



Fabio  
Novembre



Orlandini  
Design



Josh  
Owen



Palomba  
Serafini  
Associati



Pastorino  
& Suarez



Jake  
Phipps



Marcello  
Pozzi



Meneghello  
Paoletti  
Associati



Pudelskern



Karim  
Rashid



Carlo  
Stefanut



Stokkeastad



Studio 63



Studio  
Balutto



Studio  
Habits



Marta  
Szymkowiak



Marc  
Thorpe



Matteo Thun  
& Antonio  
Rodriguez



Esa  
Vesmanen



Samuel  
Wilkinson



Wis  
Design



Sean  
Yoo



Renato  
Zamberlan



StH  
Orizzonti  
Design  
Center

114 93 — 08  
 100 Alma a muro  
 098, 100 Alma a terra  
 056, 058 Anish Cassettiera  
 054 Anish Madia  
 090 Backstage  
 074, 076 Blend  
 030»036 Carlos  
 050, 052 ComRi  
 134, 136 Festival Home  
 138»144 Festival Professional  
 022, 024 Leon Decor  
 026, 028 Leon Full Color  
 012»020 Leon Wood  
 044, 104»106 Network  
 064 Not Riddled  
 082, 084 Opus Incertum  
 060, 062 Polka Dots  
 128»132 QuaDror™ 04  
 066, 068 Riddled Front  
 092, 094 Robox  
 120, 122 Sendai  
 124, 126 Sendai Crystal  
 096 Sinapsi  
 112 Singles  
 070, 072 Solaio Armadio  
 116, 118 Solaio Libreria  
 046, 048, 110 Spectro  
 048, 108, 110 Sudoku  
 038»042 Tide Buffet  
 044 Tide Comò  
 086, 088 Urban  
 078 Valises  
 102 Web Stopper  
 146»150 Web System

153 Finiture e materiali  
 Finishes and materials

170 Legenda dei simboli  
 Key to symbols

169 Schede tecniche  
 Technical sheets

Madie, comò, armadi e cassettiere  
 Sideboards, dressers, wardrobes, and chests of drawers  
 Buffets, comò, armoires et commodes  
 Sideboards, Kleiderschränke und Schubladenschränke  
 Aparadores, armarios y cajoneras



Anish Cassettiera  
 056, 058



Anish Madia  
 054



Blend  
 074, 076



Carlos  
 030, 032, 034, 036



ComRi  
 050, 052



Leon Decor  
 022, 024



Leon Full Color  
 026, 028



Leon Wood  
 012, 014, 016, 018, 020



Not Riddled  
 064



Polka Dots  
 060, 062



Riddled Front  
 066, 068



Solaio Armadio  
 070, 072



Spectro  
 046, 048, 110



Tide Buffet  
 038, 040, 042



Tide Comò  
044



Valises  
078

Librerie, scaffalature, mensole e contenitori multiuso  
Bookcases, shelf units, and wall-mounted shelves  
Bibliothèques, étagères et rangement murales  
Bücherregale, Modulares Regale und Wandregale  
Librerías, estanterías y sistemas modulares



93 – 08  
114



Alma a muro  
100



Alma a terra  
098, 100



Backstage  
90



Festival Home  
134, 136



Festival Professional  
138, 140, 142, 144



Network  
044, 104, 106

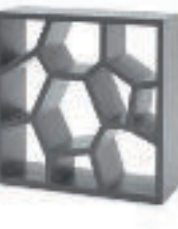

Opus Incertum  
082, 084



QuaDroi™ 04  
128, 130, 132



Robox  
092, 094



Sendai  
120, 122



Sendai Crystal  
124, 126



Sinapsi  
096



Singles  
112



Solaio Libreria  
116, 118



Sudoku  
048, 108, 110



Urban  
086, 088



Web Stopper  
102

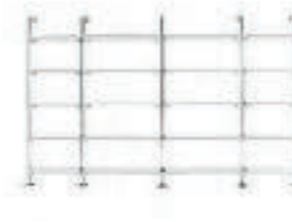

Web System  
146, 148, 150

---

Contenitori  
Storage Units  
Meubles de rangement  
Sideboards  
Aparadores

---

## Leon Wood

madia / sideboard  
HORM / SH, 2002  
» [technical info p. 186](#)





## Leon Wood

madia / sideboard  
HORM / SH, 2002  
» [technical info p. 186](#)



# Leon Wood

media / sideboard  
HORM / SH, 2002  
» technical info p. 186



# Leon Wood

madia / sideboard  
HORM / SH, 2002  
» [technical info p. 186](#)



Mamanonmama  
specchio / mirror  
vol. 03

## Leon Wood

madia / sideboard  
HORM / SH, 2002  
» [technical info p. 186](#)

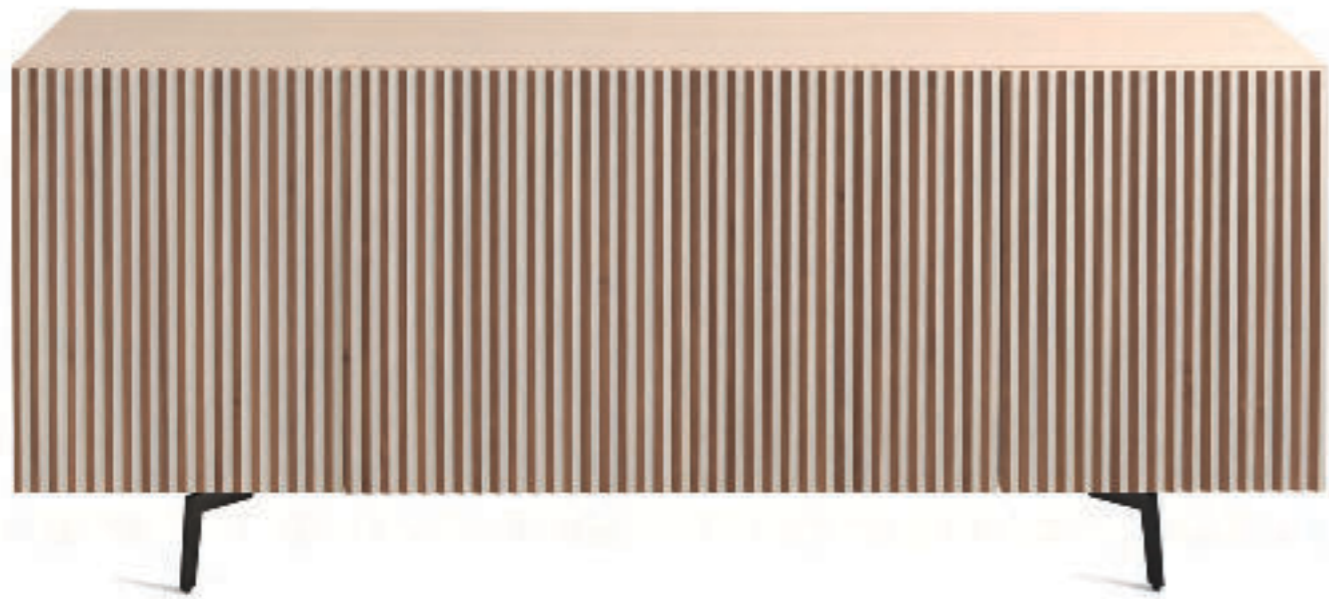

## Leon Decor

madia / sideboard  
 HORM / SH, 2018  
 » [technical info p. 184](#)



Barbara  
 tavolo / table  
 vol. 01

Lepel Sedia  
 sedia / chair  
 vol. 01

## Leon Decor

media / sideboard  
HORM / SH, 2018  
» technical info p. 184



026

## Leon Full Color

madia / sideboard  
HORM / SH, 2018  
» [technical info p. 185](#)

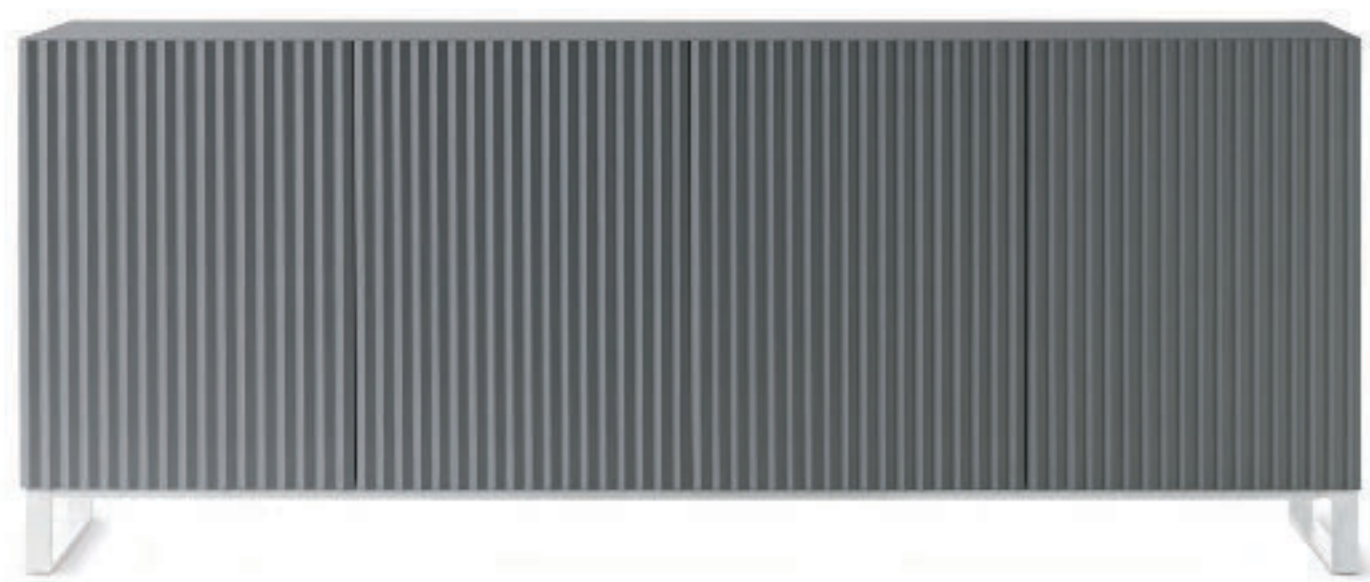

## Leon Full Color

madia / sideboard  
HORM / SH, 2018  
» [technical info p. 185](#)

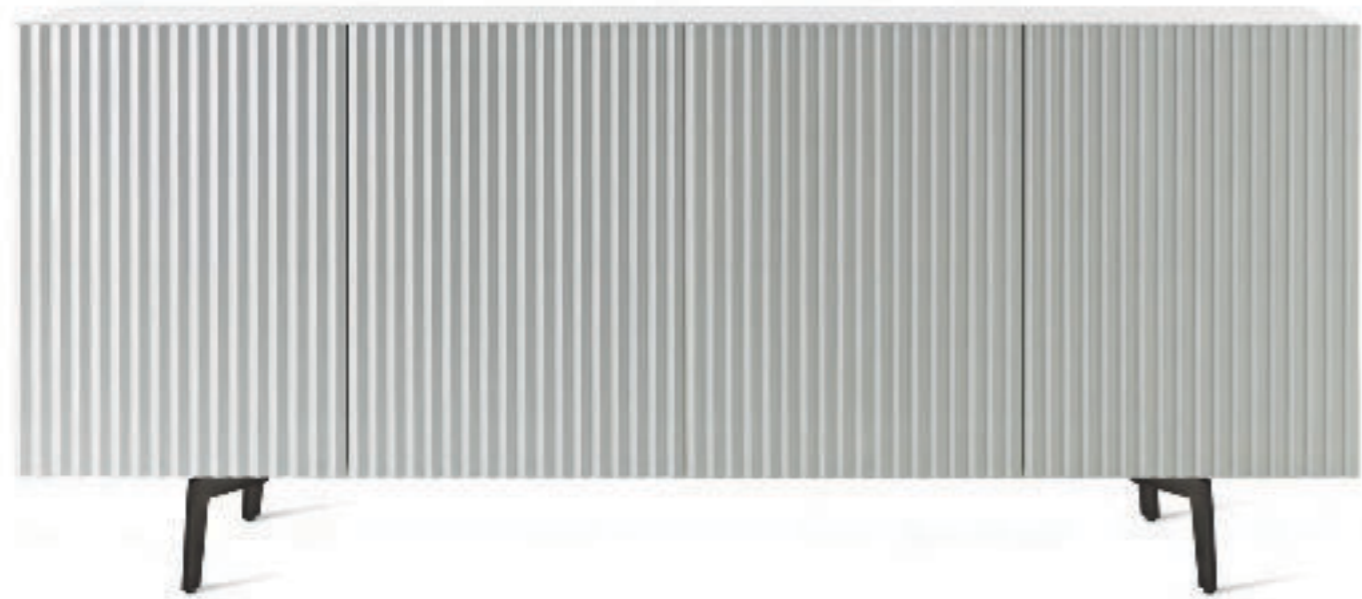



## Carlos

madia / sideboard  
HORM / Renato Zamberlan, 2014  
» [technical info p. 178](#)



## Carlos

madia / sideboard  
HORM / Renato Zamberlan, 2014  
» [technical info p. 178](#)



## Carlos

madia / sideboard  
 HORM / Renato Zamberlan, 2014  
 » [technical info p. 178](#)



Ray Poltroncina  
 sedia con braccioli / chair with armrests  
 vol. 01

Autoreggente Tavolo  
 tavolo / table  
 vol. 01

036

## Carlos

media / sideboard  
HORM / Renato Zamberlan, 2014  
» [technical info p. 178](#)



037



H

## Tide Buffet

media / sideboard  
 HORM / Karim Rashid, 2006  
 » technical info p. 202



## Tide Buffet

media / sideboard  
HORM / Karim Rashid, 2006  
» [technical info p. 202](#)



## Tide Buffet

media / sideboard  
HORM / Karim Rashid, 2006  
» [technical info p. 202](#)



## Tide Comò

comò / chest of drawers  
 HORM / Karim Rashid, 2006  
 » [technical info p. 203](#)



## Network

libreria / bookcase  
 CASAMANIA / Neuland, Paster & Geldmacher, 2014  
 » [technical info p. 187](#)





## Spectro

madia / sideboard  
 CASAMANIA / Claesson Koivisto Rune, 2018  
 » [technical info p. 200](#)

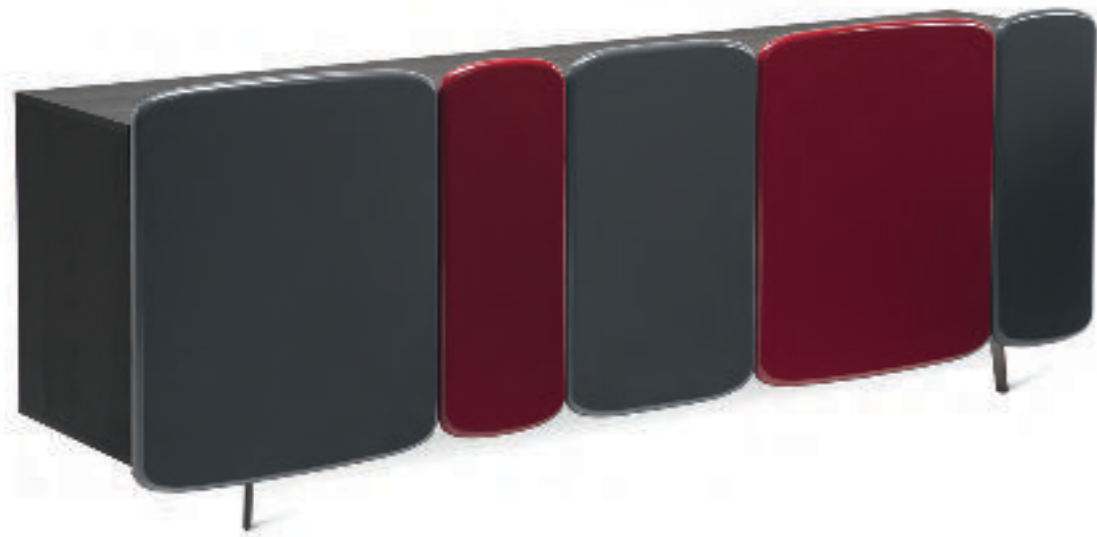

Cherish  
 sedia / chair  
 vol. 01

Bolero  
 tavolo / table  
 vol. 01

## Spectro

madia / sideboard  
CASAMANIA / Claesson Koivisto Rune, 2018  
» [technical info p. 200](#)

## Sudoku

libreria / bookcase  
HORM / Mario Bellini, 2007  
» [technical info p. 201](#)



## ComRi

media / sideboard

HORM / SHH - homage to Toyo Ito, 2010

» [technical info p. 179](#)



## ComRi

madia / sideboard  
 HORM / SHH - homage to Toyo Ito, 2010  
 » [technical info p. 179](#)



Yume  
 specchio / mirror  
 vol. 03

## Anish Madia

madia / sideboard  
HORM / Indriolo & Gaspardo, 2011  
» [technical info p. 175](#)



## Anish Cassettiera

cassettiera / chest of drawers  
HORM / Indriolo & Gaspardo, 2011  
» [technical info p. 174](#)



058

## Anish Cassettiera

cassettiera / chest of drawers  
HORM / Indriolo & Gaspardo, 2011  
» [technical info p. 174](#)

059

Nest  
letto / bed  
vol. 04

HC

## Polka Dots

madia / sideboard  
HORM / Toyo Ito, 2003  
» [technical info p. 190](#)



Ginevra  
sedia con braccioli / chair with armrests  
vol. 01



## Polka Dots

madia / sideboard  
HORM / Toyo Ito, 2003  
» technical info p. 190

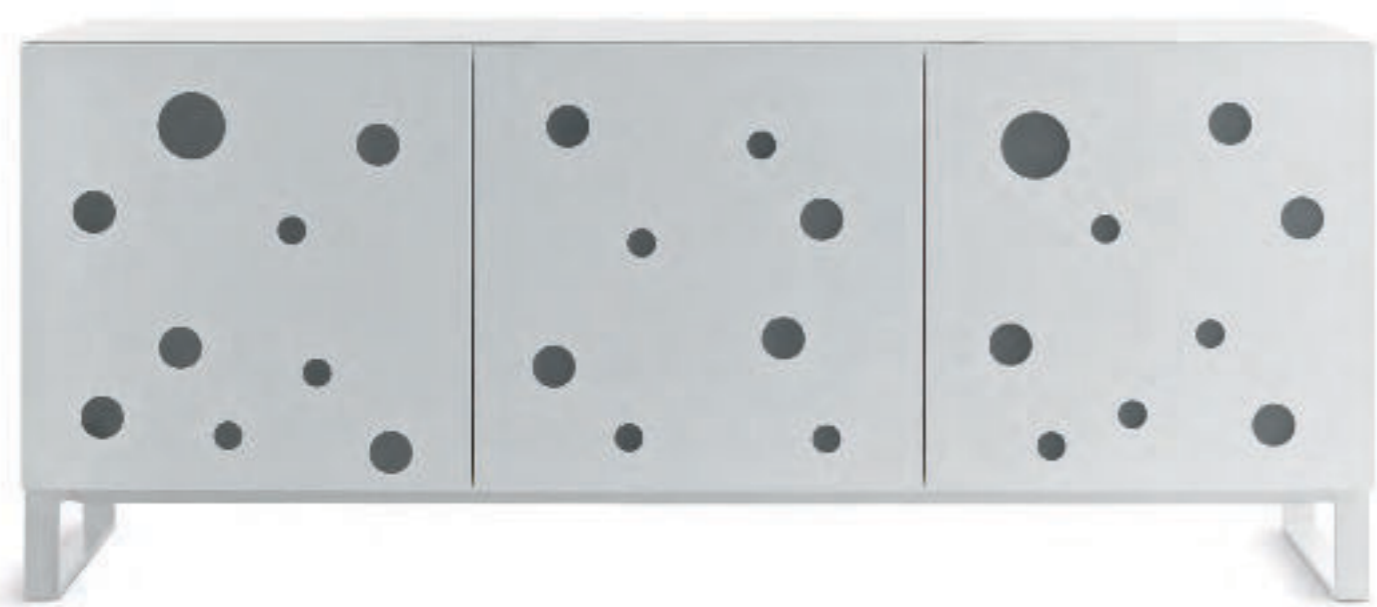

Woodclock  
orologio da parete / wall-mounted clock  
vol. 03

## Not Riddled

media / sideboard  
HORM / Steven Holl, 2007  
» [technical info p. 188](#)



## Riddled Front

media / sideboard  
HORM / Steven Holl, 2007  
» [technical info p. 192](#)



## Riddled Front

media / sideboard  
HORM / Steven Holl, 2007  
» technical info p. 192



## Solaio Armadio

armadio / wardrobe  
HORM / Carlo Cumini, 1997  
» technical info p. 198



## Solaio Armadio

armadio / wardrobe  
HORM / Carlo Cumini, 1997  
» [technical info p. 198](#)



## Blend

armadio / wardrobe  
HORM / Karim Rashid, 2006  
» [technical info p. 177](#)



## Blend

armadio / wardrobe  
HORM / Karim Rashid, 2006  
» [technical info p. 177](#)





## Valises

armadio / wardrobe  
CASAMANIA / Maarten De Ceulaer, 2008  
» technical info p. 204



---

Mensole e Librerie  
Shelving Solutions  
Etagères et Bibliothèques  
Wandregale und Bücherregale  
Estanterías y Librerías

---

## Opus Incertum

contenitore multiuso / multiuse shelf organizer

CASAMANIA / Sean Yoo, 2005

» technical info p. 189



Velasca  
sedia con braccioli / chair with armrests  
vol. 01

## Opus Incertum

contenitore multiuso / multiuse shelf organizer  
CASAMANIA / Sean Yoo, 2005  
» [technical info p. 189](#)



Morfino & Morfino Pouf  
bean bag e pouf / bean bag and ottoman  
vol. 03

## Urban

contenitore multiuso / multiuse shelf organizer

CASAMANIA / Claudio Bellini, 2009

» [technical info p. 204](#)



## Urban

libreria / bookcase  
 CASAMANIA / Claudio Bellini, 2009  
 » technical info p. 204



Raphia Rattan  
 sedia con braccioli / chair with armrests  
 vol. 01

## Backstage

contenitore multiuso / multiuse storage organizer  
HORM / Salvatore Indriolo, 2010  
» [technical info p. 176](#)



## Robox

libreria / bookcase  
CASAMANIA / Fabio Novembre, 2011  
» [technical info p. 193](#)

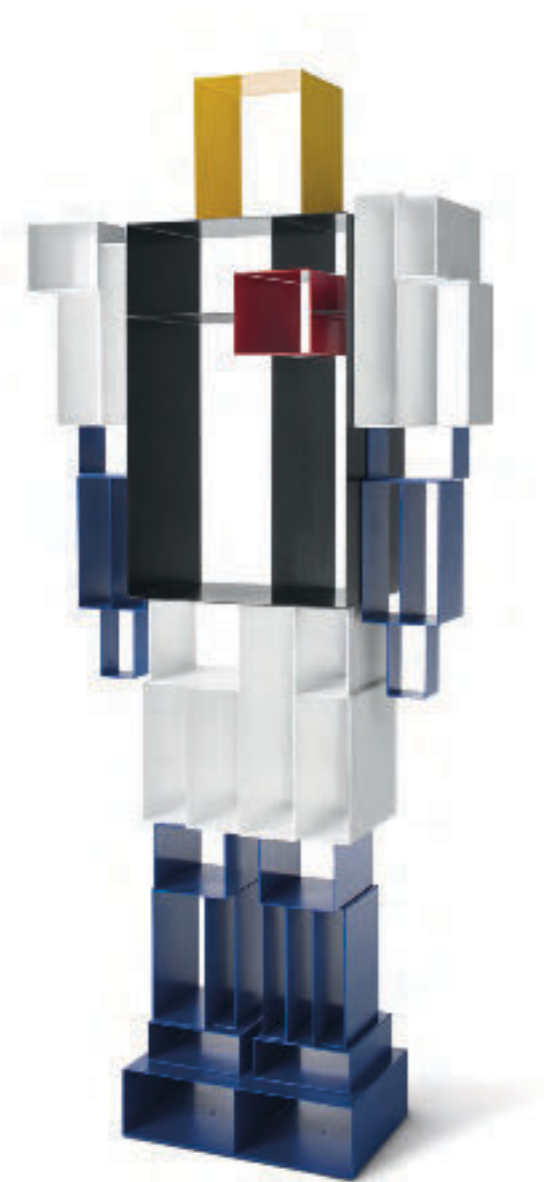



## Robox

libreria / bookcase  
CASAMANIA / Fabio Novembre, 2011  
» [technical info p. 193](#)

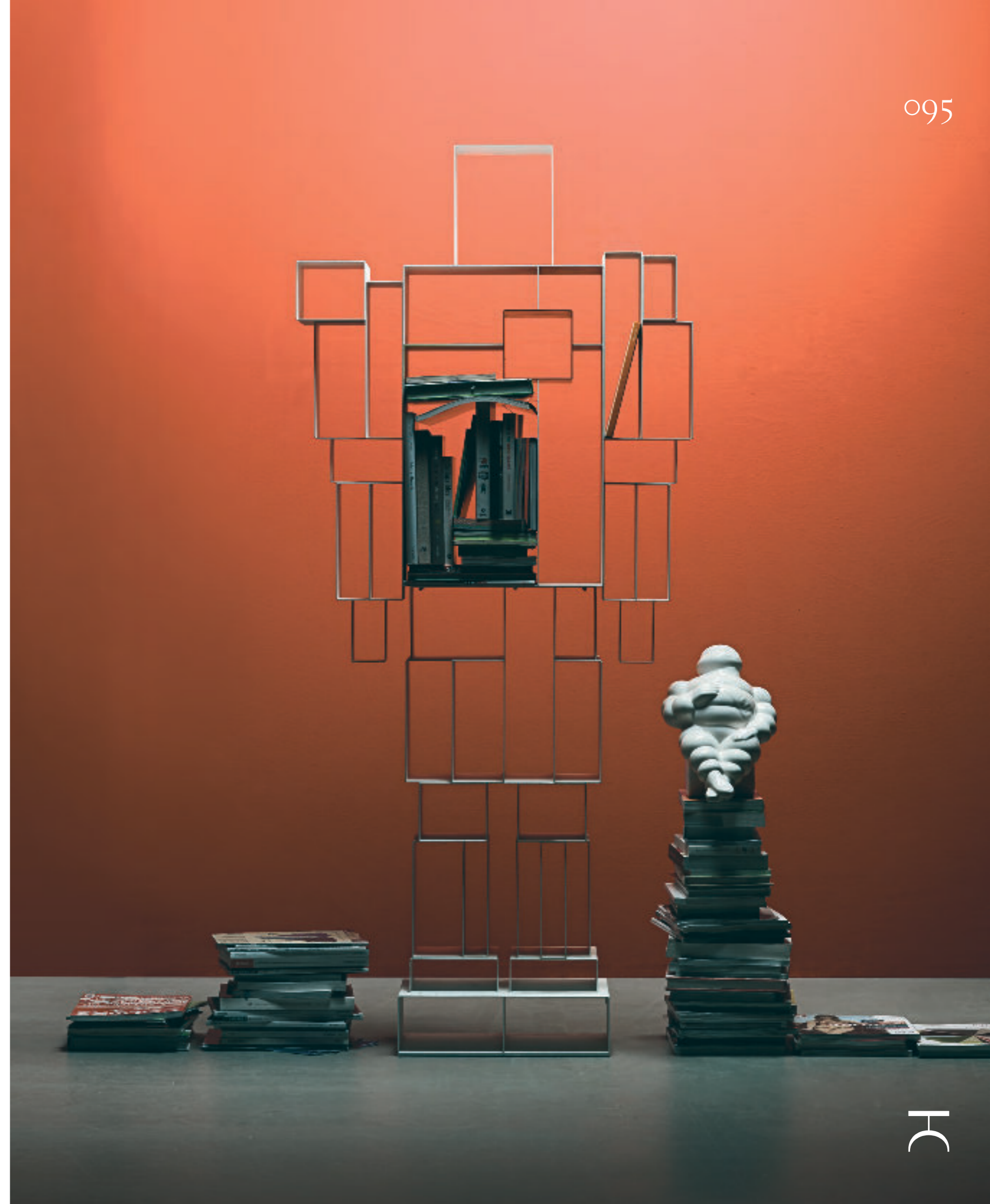

## Sinapsi

mensola a parete / wall shelf  
HORM / Sebastian Errazuriz, 2010  
» [technical info p. 196](#)

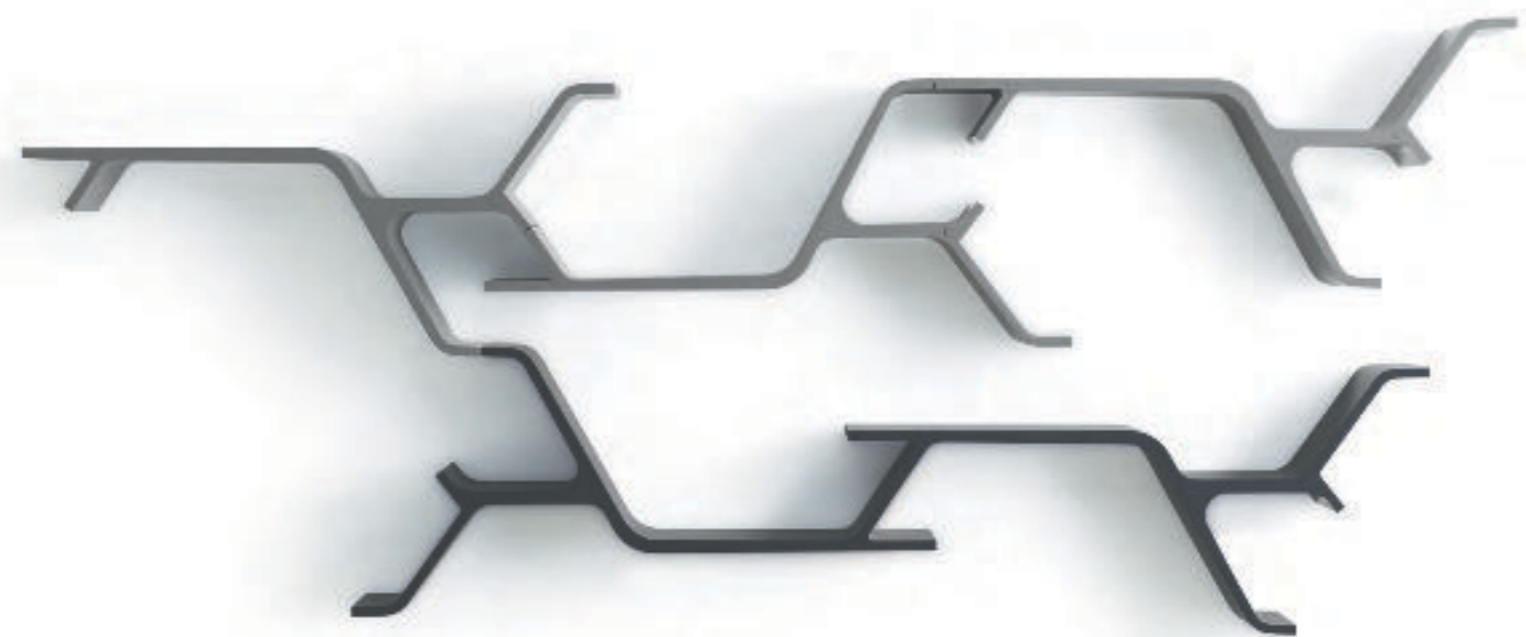

## Alma a terra

contenitore multiuso / multiuse storage organizer  
CASAMANIA / Studio 63, 2011 – 2012  
» [technical info p. 173](#)



## Alma a muro

contenitore multiuso / multiuse wall mounted shelf organizer  
 CASAMANIA / Studio 63, 2011 – 2012  
 » [technical info p. 173](#)

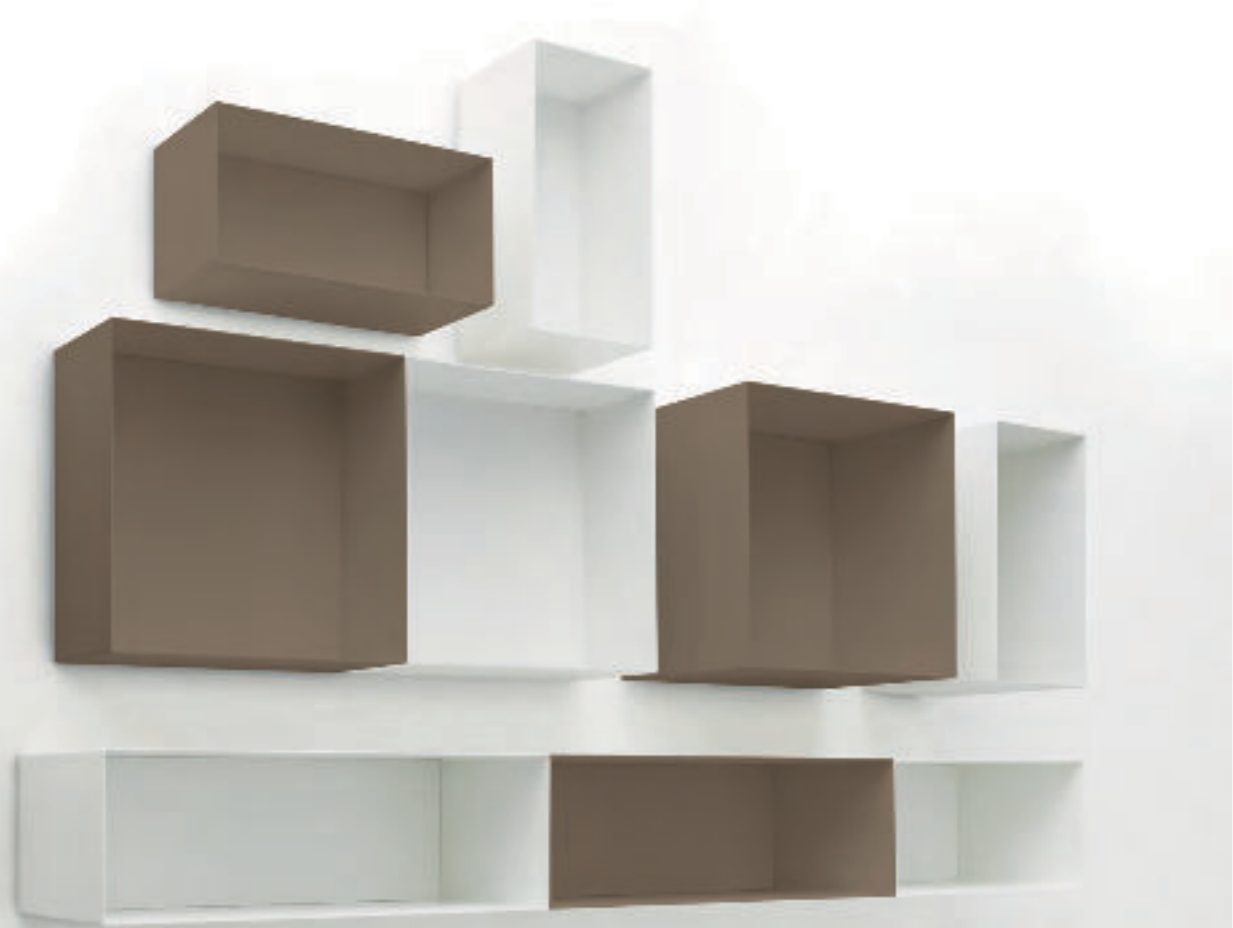

## Alma a terra

contenitore multiuso / multiuse storage organizer  
 CASAMANIA / Studio 63, 2011 – 2012  
 » [technical info p. 173](#)



## Web Stopper

mensola a parete / wall shelf  
CASAMANIA / Menguzzato & Nascimben, 2006  
» [technical info p. 205](#)



## Network

libreria / bookcase

CASAMANIA / Neuland, Pasteur & Geldmacher, 2014

» [technical info p. 187](#)



## Network

libreria / bookcase

CASAMANIA / Neuland, Pasteur & Geldmacher, 2014

» technical info p. 187



Giro Pouf  
pouf / ottoman  
vol. 01



## Singles

libreria / bookcase  
 HORM / Carlo Cumini, 2004  
 » technical info p. 197





93 - 08

libreria / bookcase  
HORM / Carlo Cumini, 2008  
» technical info p. 172



## Solaio Libreria

libreria / bookcase  
 HORM / Carlo Cumini, 1993 – 2018  
 » technical info p. 199



Samoa Large  
 divano letto / sofa bed  
 vol. 04

Giro Tavolino  
 tavolino / coffee table  
 vol. 01

Giro Pouf  
 pouf / ottoman  
 vol. 01

## Solaio Libreria

libreria / bookcase  
HORM / Carlo Cumini, 1993 – 2018  
» [technical info p. 199](#)

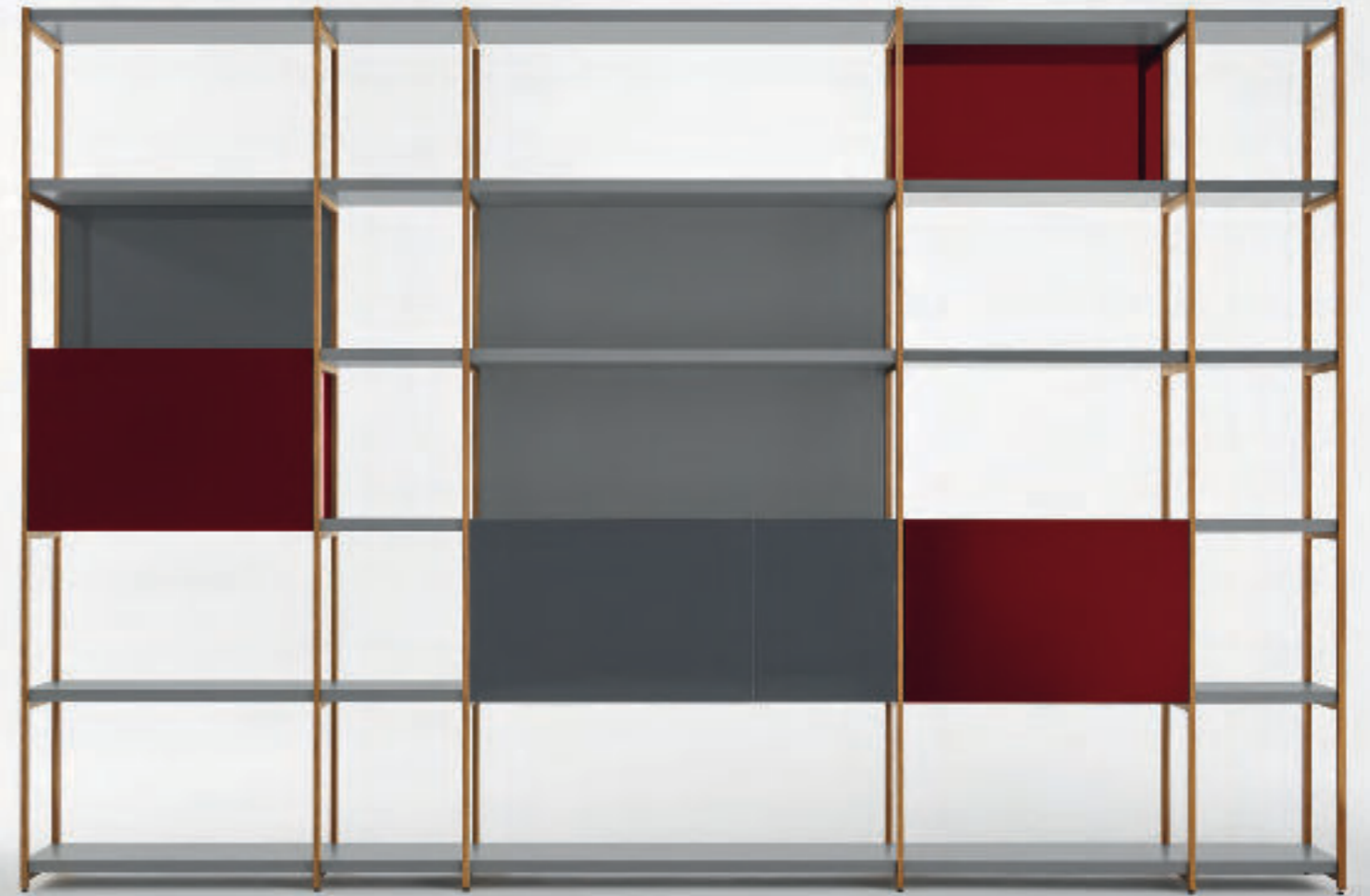

## Sendai

libreria / bookcase  
HORM / Toyo Ito, 2004  
» [technical info p. 194](#)

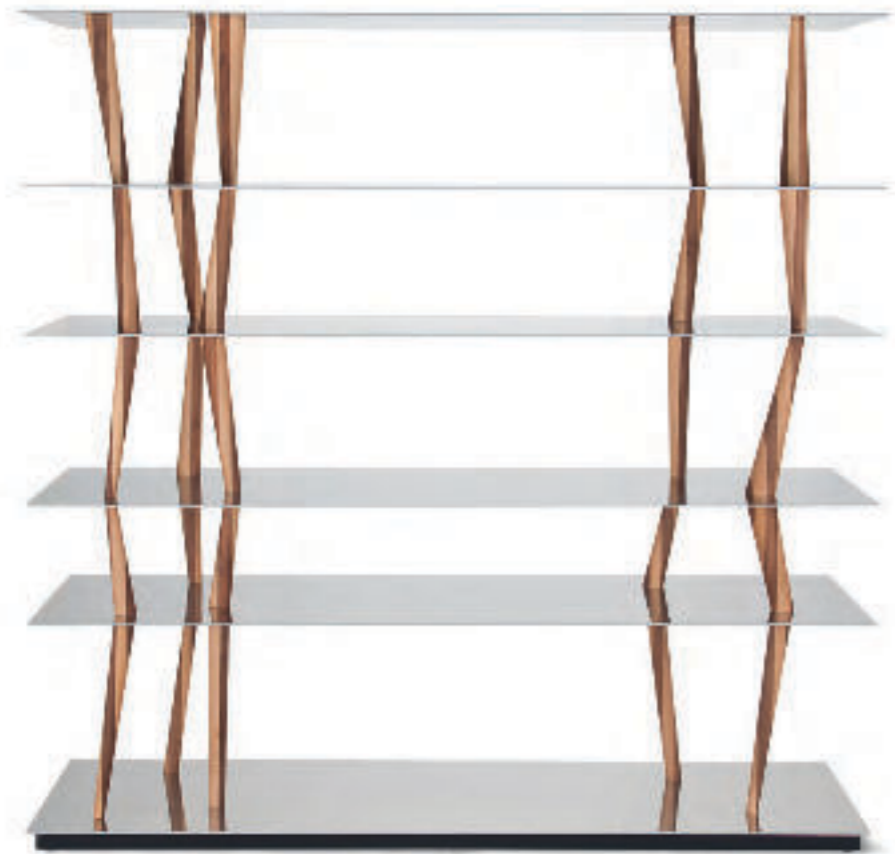

## Sendai

libreria / bookcase  
 HORM / Toyo Ito, 2004  
 » [technical info p. 194](#)



Ripples  
 panca / bench  
 vol. 01

Hexagon  
 tavolino / side table  
 vol. 01

Mamanonmama  
 specchio / mirror  
 vol. 03

## Sendai Crystal

libreria / bookcase  
HORM / Toyo Ito, 2013  
» technical info p. 195

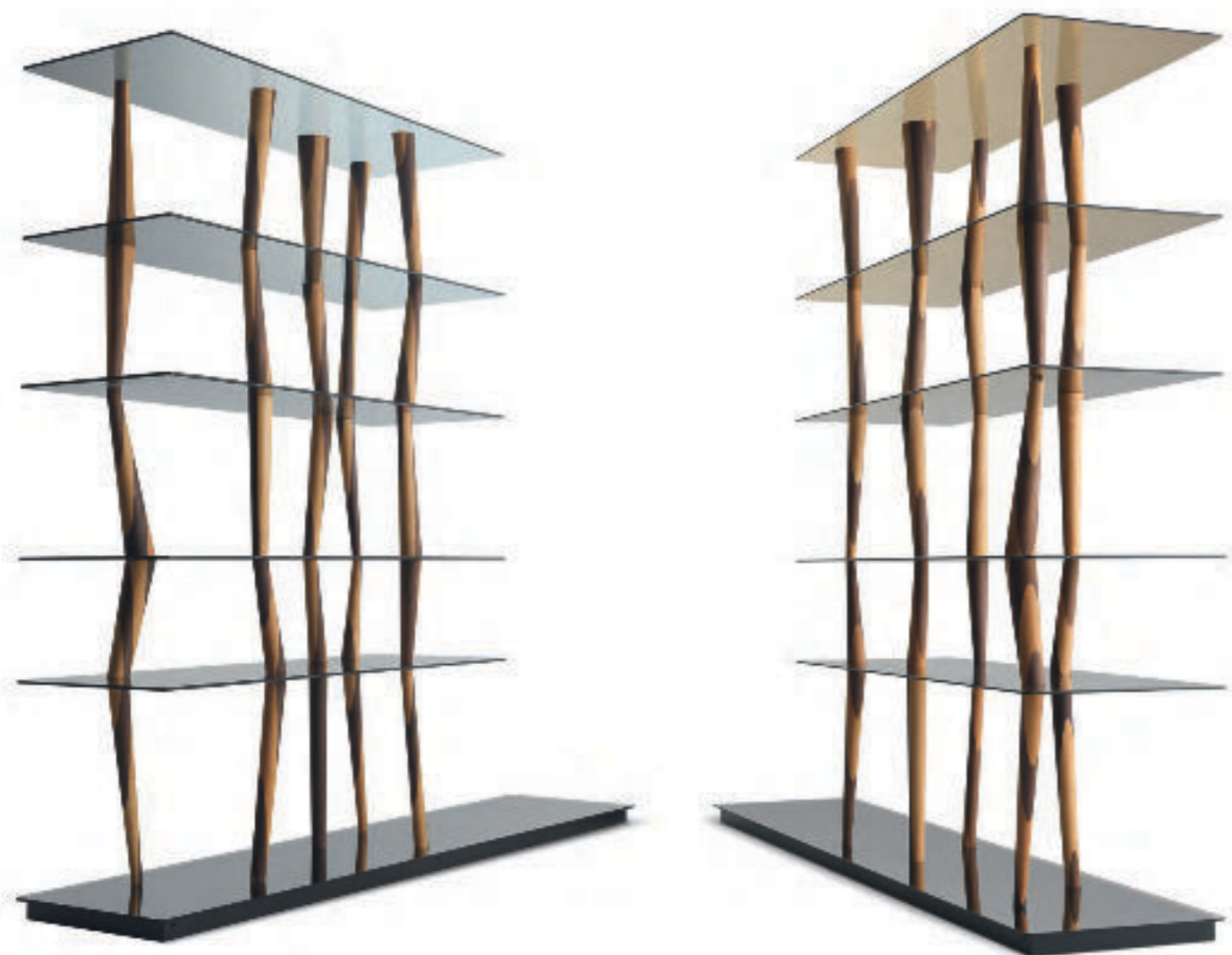

## Sendai Crystal

libreria / bookcase  
HORM / Toyo Ito, 2013  
» technical info p. 195

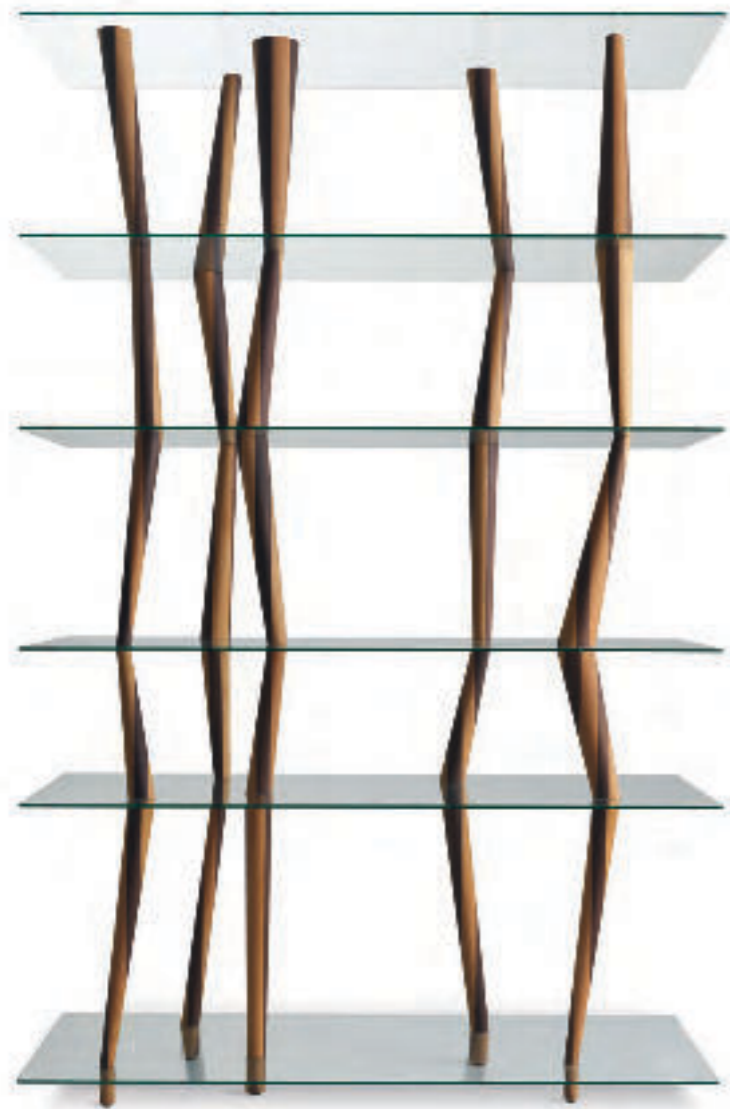

# QuaDror™ 04

libreria / bookcase  
HORM / Dror, 2015  
» technical info p. 191





## QuaDror™ 04

libreria / bookcase  
 HORM / Dror, 2015  
 » technical info p. 191

Ray Poltroncina  
 sedia con braccioli / chair with armrests  
 vol. 01

QuaDror™ 02  
 tavolo / table  
 vol. 01

# QuaDror™ 04

libreria / bookcase  
HORM / Dror, 2015  
» technical info p. 191

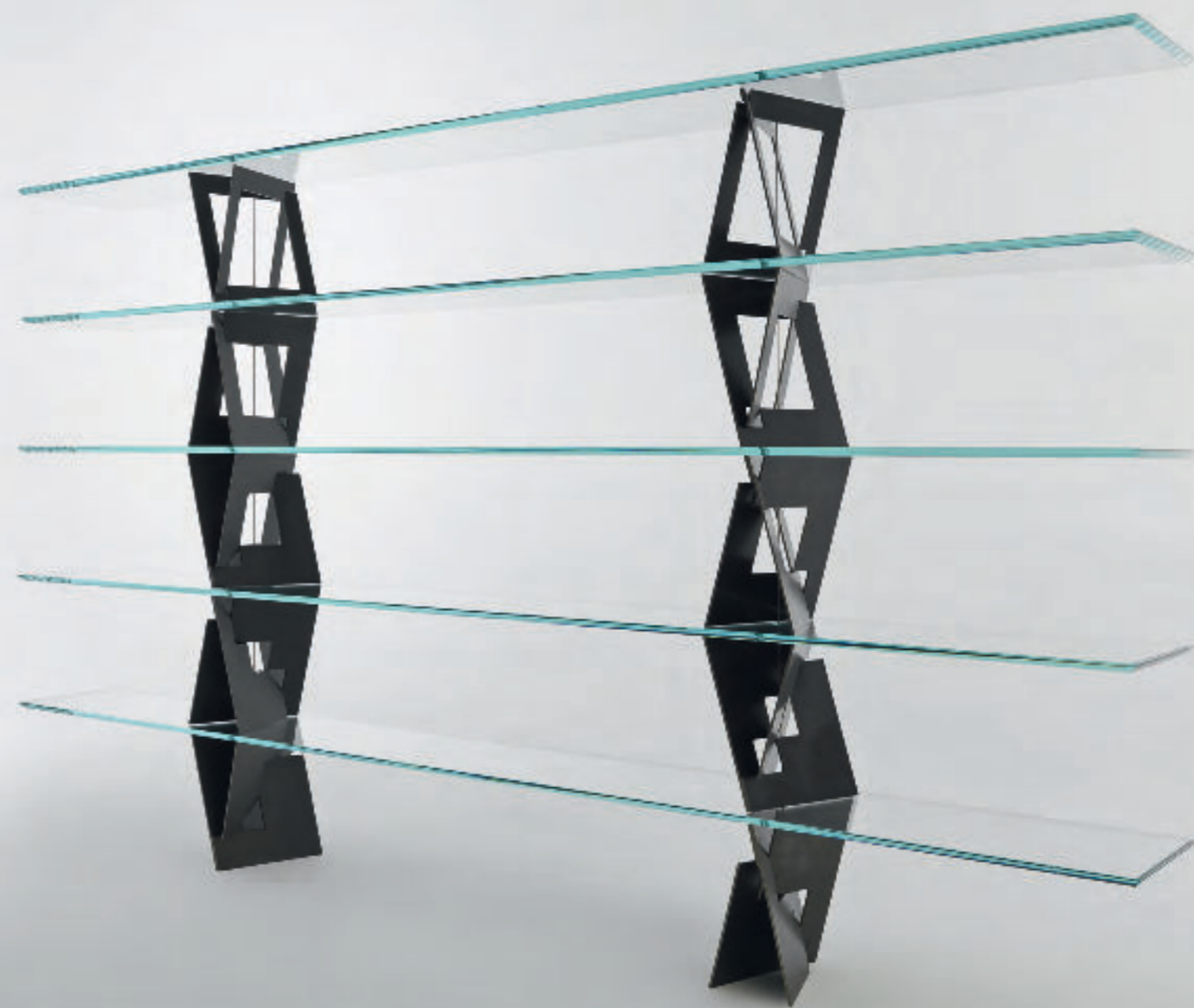

## Festival Home

scaffalatura / shelving system  
CASAMANIA / Baldanzi & Novelli, 1987  
» [technical info p. 180](#)



## Festival Home

scaffalatura / shelving system  
CASAMANIA / Baldanzi & Novelli, 1987  
» [technical info p. 180](#)



## Festival Professional

scaffalatura / shelving system  
CASAMANIA / Baldanzi & Novelli, 1987  
» technical info p. 182



## Festival Professional

scaffalatura / shelving system  
 CASAMANIA / Baldanzi & Novelli, 1987  
 » [technical info p. 182](#)

Morfino Pouf  
 pouf / ottoman  
 vol. 01

Maria  
 oggetto decorativo / decorative object  
 vol. 03

Korzina  
 gettacarte / wastepaper basket  
 vol. 03

# Festival Professional

scaffalatura / shelving system  
CASAMANIA / Baldanzi & Novelli, 1987  
» [technical info p. 182](#)



## Festival Professional

scaffalatura / shelving system  
 CASAMANIA / Baldanzi & Novelli, 1987  
 » technical info p. 182

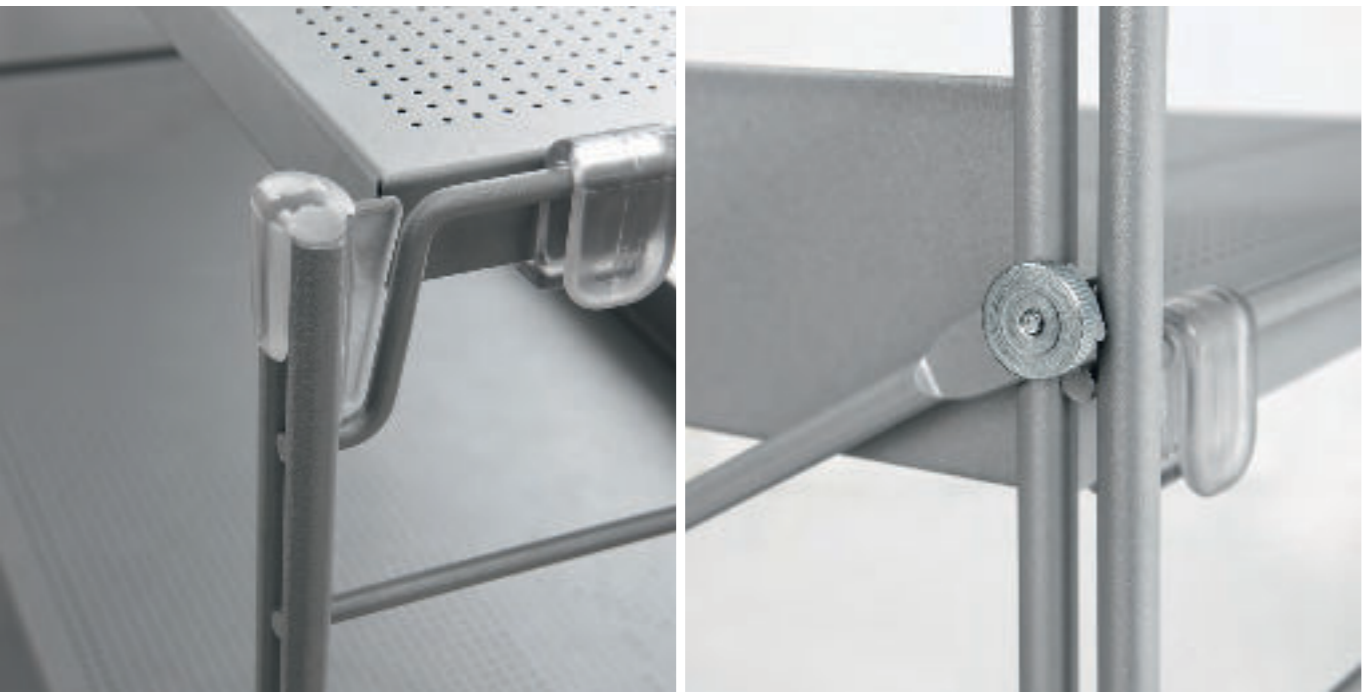



## Web System

scaffalatura / shelving system

CASAMANIA / Menguzzato & Nascimben, 2001

» technical info p. 206



## Web System

scaffalatura / shelving system

CASAMANIA / Menguzzato & Nascimben, 2001

» [technical info p. 206](#)



## Web System

scaffalatura / shelving system

CASAMANIA / Menguzzato & Nascimben, 2001

» [technical info p. 206](#)



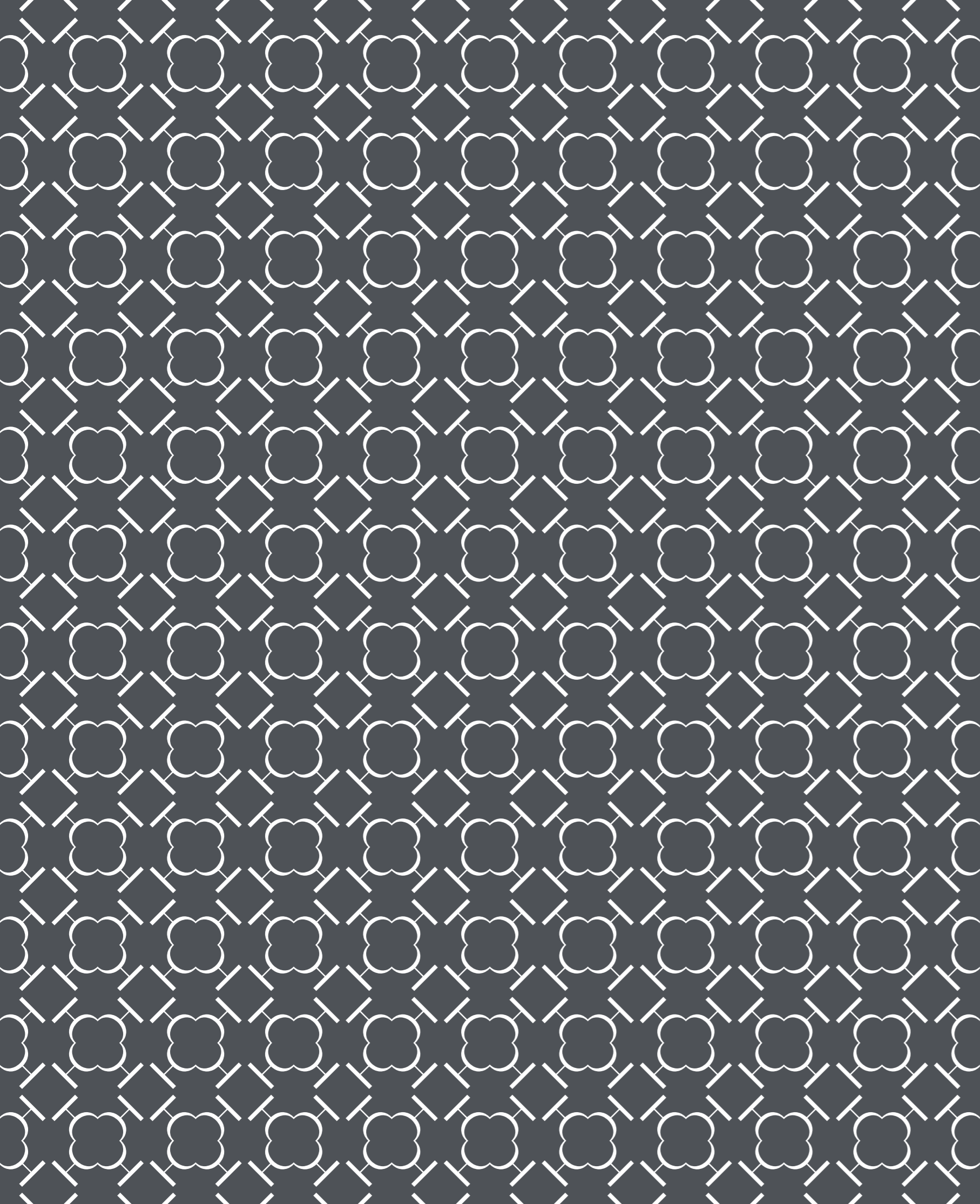

---

Finiture e materiali  
Finishes and materials  
Finitions et matériaux  
Ausführungen und Materialien  
Acabados y materiales

---

faggio imbiancato  
whitened beech  
hêtre blanchi  
Buche geweißt  
haya blanqueada



Cherish / Hcb /  
Leon Wood / Ray Sedia /  
Spectro / Twist

faggio naturale  
natural beech  
hêtre naturel  
Buche Natur  
haya natural



Cherish / Twist

faggio bois blond  
bois blond beech  
hêtre bois blond  
Buche Bois Blond  
haya bois blond



Hcb / Leon Wood /  
Spectro / Twist

faggio mocha  
mocha beech  
hêtre moka  
Buche Mokka  
haya mocha



Anish / Carlos / Cherish /  
Hcb / Leon Wood / Pressious /  
Ray Sedia / Spectro / Twist

frassino bianco  
white ash  
frêne blanc  
Esche Weiß  
fresno blanco



Ki

frassino tinto rovere  
oak-stained ash  
frêne teinté chêne  
eichefarbig gebeizt Esche  
fresno teñido roble

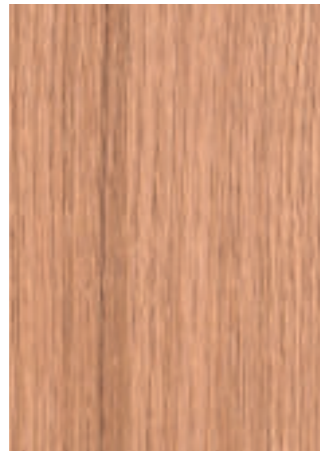

La Dina / Milady /  
Velasca

frassino beige  
beige grey ash  
frêne gris beige  
Esche Beigegrau  
fresno gris beige



Carnaby / La Dina /  
Milady / Velasca

frassino mocha  
mocha ash  
frêne moka  
Esche Mokka  
fresno mocha

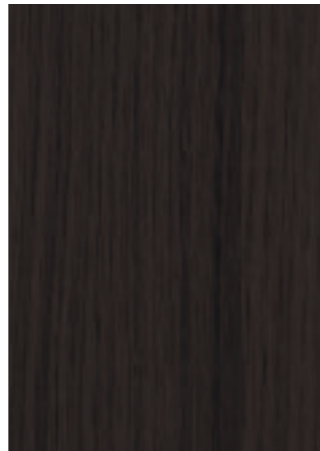

La Dina / Ma.Re /  
QuaDror 01 / QuaDror 03 /  
QuaDror 04

frassino nero  
black ash  
frêne noir  
Esche Schwarz  
fresno negro

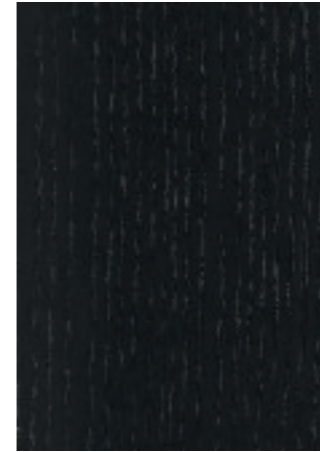

Carnaby / Ki / Milady /  
Pablita / Sienna / Soho /  
Velasca

rovere bianco  
white oak  
chêne blanc  
Eiche Weiß  
roble blanco



Andaman / Chariot /  
Meduse Tavolo / Moheli / Xx

rovere naturale  
natural oak  
chêne naturel  
Eiche Natur  
roble natural



Alberto Appendiabiti / Albino Family / Autoreggente Tavolo /  
Bolero / Capriata / Chariot / Cobra / Giro Tavolino /  
J – Table / Leon Decor / Lily / Maritime / Meduse Tavolo /  
Ray Poltroncina & Sedia / Solaio Armadio & Libreria / Sottiletto /  
Stereo Wood / Tango / Twine / Twine Tavolino / Vad Wood /  
Woodclock / Wow! Plus / Xx

rovere beige  
beige grey oak  
chêne gris beige  
Eiche Beigegrau  
roble gris beige

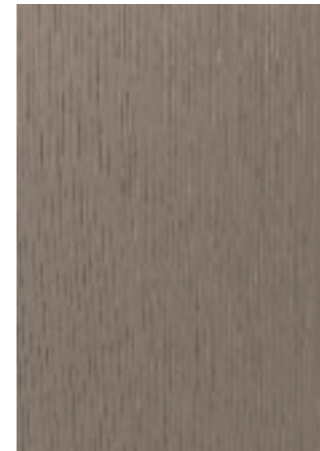

Maritime

rovere mocha  
mocha oak  
chêne moka  
Eiche Mokka  
roble mocha

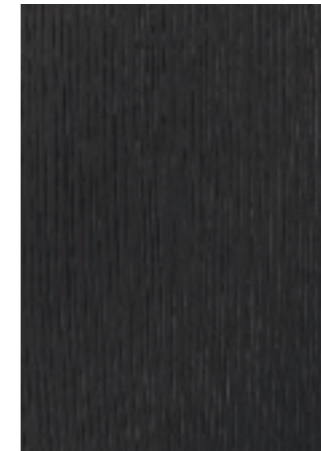

Andaman / Barbara /  
Capriata / Chariot / Cobra /  
Maritime / Meduse Tavolo /  
Moheli / Solaio Armadio &  
Libreria / Sottiletto /  
Twine Tavolino / Xx

noce canaletto  
walnut  
noyer  
Nussbaum  
nogal

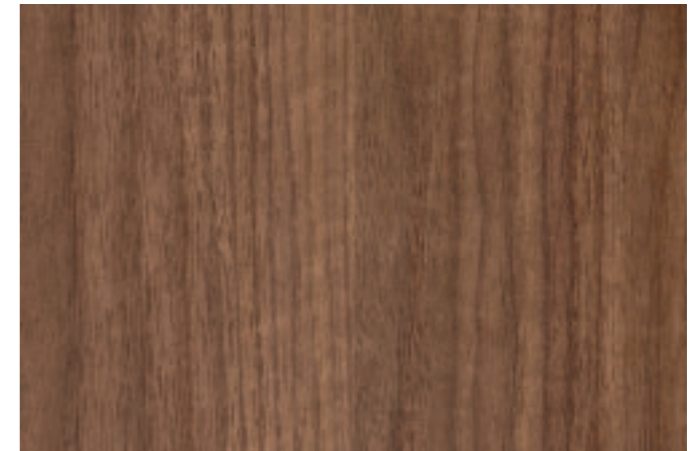

93 – 08 / Albino Family / Albino Torcia / Anish /  
Autoreggente / Barbara / Bifronte / Bolero / Bureau / Cobra /  
Flower / Ginevra / Io e Te / J – Table / Ki / Leon Decor /  
Lily / Meduse Tavolo / Numero 3 / Ray Poltroncina & Sedia /  
Singles / Sottiletto / Stereo Wood / Tango / Tribeca / Tutù /  
Twine / Twine Tavolino / Vad Wood / Wow! Plus / Woodclock

okumé  
okoume  
okumé  
Okume  
ocume



Hexagon / Ripples Outdoor

ontano + noce canaletto  
alder + walnut  
aulne + noyer  
Erle + Nussbaum  
aliso + nogal



Sendai / Sendai Crystal

nero-bianco  
black-white  
noir-blanc  
Schwarz-Weiß  
negro-blanco

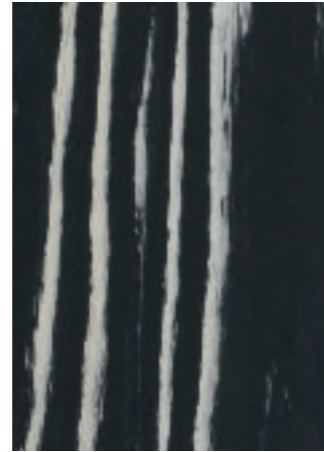

Sudoku

salice nero  
black willow  
saule noir  
Weide Schwarz  
sauce negro



Mamanonmama

legno origami in noce canaletto — brevetto HORM  
origami wood in walnut — HORM patent  
bois origami en noyer — brevet HORM  
Origami-Nussbaum — HORM-Patent  
madera origami de nogal — patente HORM



Not Riddled / Plywood Chandelier / Riddled Front /  
Riddled Table / Riddled Totem

legno origami in ebano — brevetto HORM  
origami wood in ebony — HORM patent  
bois origami en ébène — brevet HORM  
Origami-Ebenholz — HORM-Patent  
madera origami de ébano — patente HORM



Riddled Buffet

rovere termotrattato + HPL bianco  
thermo-treated oak + white HPL  
chêne thermotraité + HPL blanc  
wärmebehandelte Eiche + HPL Weiß  
roble termotrattado + HPL blanco

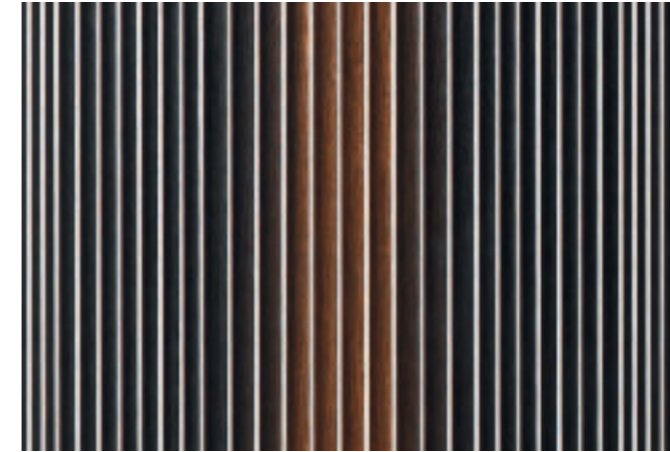

Carlos

noce canaletto / mogano / ciliegio / rovere / frassino  
walnut / mahogany / cherry / oak / ash  
noyer / acajou / cerisier / chêne / frêne  
Nussbaum / Mahagoni / Kirsche / Eiche / Esche  
nogal / caoba / cerezo / roble / fresno



Bifronte / ComRi / Ripples / Ripples — Like a River /  
Ripples Sgabello / Ripples Tavolo

faggio imbiancato / faggio moca / faggio naturale  
whitened beech / mocha beech / natural beech  
hêtre blanchi / hêtre moka / hêtre naturel  
Buche geweißt / Buche Mokka / Buche Natur  
haya blanqueada / haya moca / haya natural



Twist Tricolor

faggio imbiancato / faggio bois blond / arancio / giallo  
whitened beech / bois blond beech / orange / yellow  
hêtre blanchi / hêtre bois blond / orange / jaune  
Buche geweißt / Buche Bois Blond / Orange / Gelb  
haya blanqueada / haya bois blond / naranja / amarillo



Twist Multicolor

# Colori RAL per laccati opachi, metalli e plastiche<sup>(\*)</sup> / RAL Colors for matt lacquers, metals and plastic<sup>(\*)</sup>

nero  
black  
noir  
Schwarz  
negro



Vedi schede tecniche  
See technical sheets  
Voir les fiches techniques  
Siehe technische Datenblätter  
Ver fichas técnicas

bianco  
white  
blanc  
Weiß  
blanco

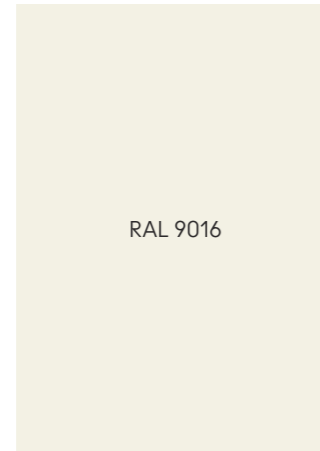

Vedi schede tecniche  
See technical sheets  
Voir les fiches techniques  
Siehe technische Datenblätter  
Ver fichas técnicas

polvere  
dusty grey  
gris poussière  
Staubgrau  
gris polvo



Vedi schede tecniche  
See technical sheets  
Voir les fiches techniques  
Siehe technische Datenblätter  
Ver fichas técnicas

beige  
beige grey  
gris beige  
Beigegrau  
gris beige



Vedi schede tecniche  
See technical sheets  
Voir les fiches techniques  
Siehe technische Datenblätter  
Ver fichas técnicas

rosso vino  
wine red  
rouge vin  
Weinrot  
rojo vino



Vedi schede tecniche  
See technical sheets  
Voir les fiches techniques  
Siehe technische Datenblätter  
Ver fichas técnicas

bruno  
brown grey  
gris brun  
Braungrau  
gris parduzco



Vedi schede tecniche  
See technical sheets  
Voir les fiches techniques  
Siehe technische Datenblätter  
Ver fichas técnicas

grafite  
graphite  
graphite  
Graphit  
grafito

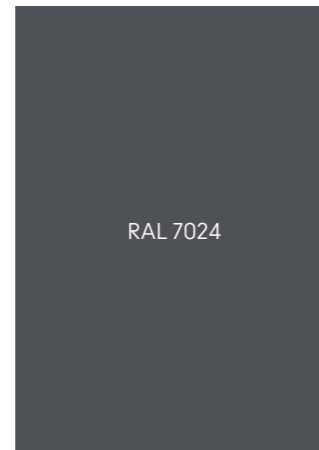

Vedi schede tecniche  
See technical sheets  
Voir les fiches techniques  
Siehe technische Datenblätter  
Ver fichas técnicas

rosso chiaro brillante  
luminous bright red  
rouge clair brillant  
Leuchthellrot  
rojo claro brillante



Chariot

# Laccati lucidi / Glossy lacquers

nero  
black  
noir  
Schwarz  
negro

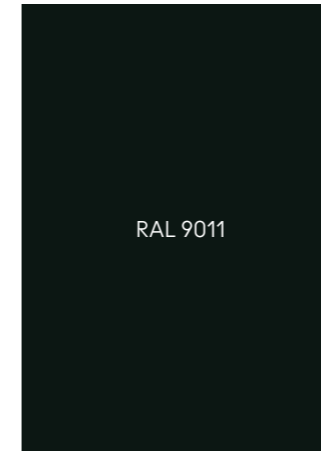

Vedi schede tecniche  
See technical sheets  
Voir les fiches techniques  
Siehe technische Datenblätter  
Ver fichas técnicas

bianco  
white  
blanc  
Weiß  
blanco

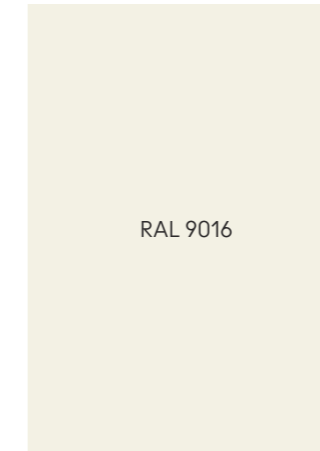

Vedi schede tecniche  
See technical sheets  
Voir les fiches techniques  
Siehe technische Datenblätter  
Ver fichas técnicas

polvere  
dusty grey  
gris poussière  
Staubgrau  
gris polvo



Vedi schede tecniche  
See technical sheets  
Voir les fiches techniques  
Siehe technische Datenblätter  
Ver fichas técnicas

beige  
beige grey  
gris beige  
Beigegrau  
gris beige



Vedi schede tecniche  
See technical sheets  
Voir les fiches techniques  
Siehe technische Datenblätter  
Ver fichas técnicas

rosso vino  
wine red  
rouge vin  
Weinrot  
rojo vino



Vedi schede tecniche  
See technical sheets  
Voir les fiches techniques  
Siehe technische Datenblätter  
Ver fichas técnicas

bruno  
brown grey  
gris brun  
Braungrau  
gris parduzco



Vedi schede tecniche  
See technical sheets  
Voir les fiches techniques  
Siehe technische Datenblätter  
Ver fichas técnicas

grafite  
graphite  
graphite  
Graphit  
grafito

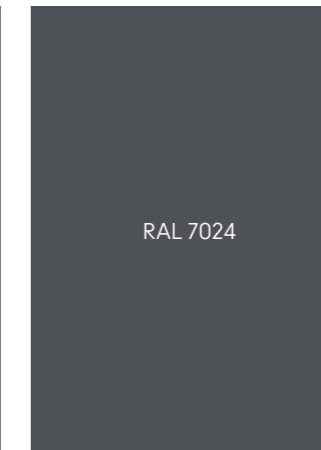

Vedi schede tecniche  
See technical sheets  
Voir les fiches techniques  
Siehe technische Datenblätter  
Ver fichas técnicas

(\*)

Polypropylene / Polyethylene / Polyamide

brunito  
burnished  
bruni  
Brüniert  
bruñido

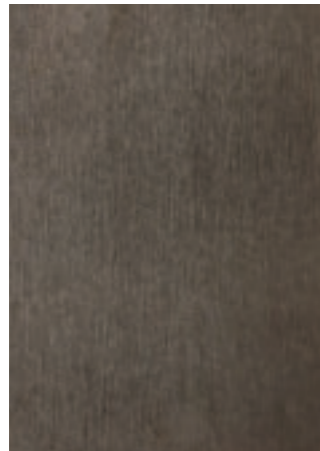

Basamento Mid-Century  
Modern

crudo  
crude  
cru  
Roh  
crudo

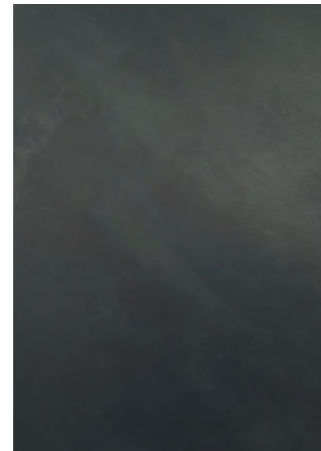

QuaDror 01 / QuaDror 02 /  
Torii

verniciato bronzo antico  
antique bronze painted  
verni bronze antique  
Vintage Bronze beschichtet  
pintado de bronce antiguo



Meduse Tavolo / Network

verniciato oro  
gold painted  
verni or  
Gold beschichtet  
pintado de oro



Chariot

cromato  
chromed  
chromé  
Chrom  
cromado



Bar / Sin / Stereo Impilabile /  
T2 / Vad Girevole /  
Vad Impilabile

cromo nero  
black chrome  
chrome noir  
Schwarz Chrom  
cromo negro



Albino Family

marmo Carrara  
Carrara marble  
marbre Carrara  
Carrara Marmor  
mármol Carrara

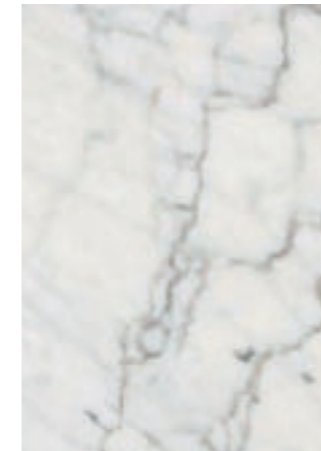

Albino Family / Flower /  
Lily / Meduse Tavolo

marmo Emperador  
Emperador marble  
marbre Emperador  
Emperador Marmor  
mármol Emperador

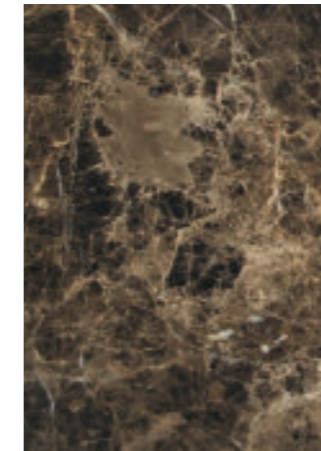

Albino Family / Barbara /  
Lily / Meduse Tavolo /  
Tout le Jour Tavolino

marmo Marquina  
Marquina marble  
marbre Marquina  
Marquina Marmor  
mármol Marquina

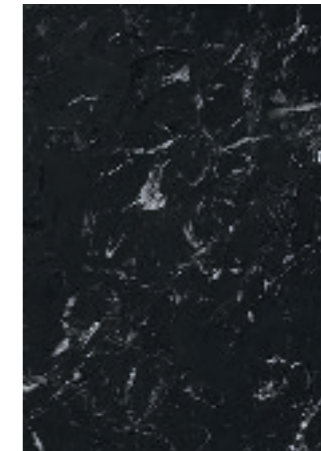

Albino Family / Barbara /  
Flower / Lily / Meduse  
Tavolo / Tout le Jour Tavolino

pietra leccese  
Lecce limestone  
pierre de Lecce  
Lecce-Stein  
piedra de Lecce

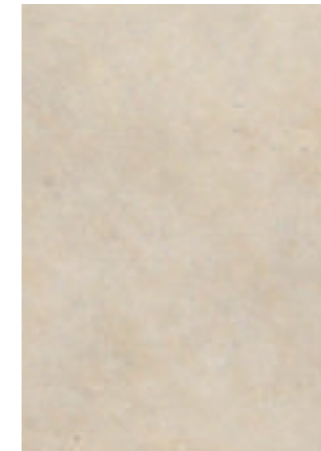

Hexagon

ceramica grigia  
grey ceramic  
céramique gris  
graue Keramik  
cerámica gris

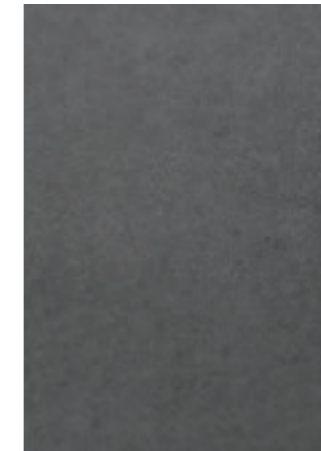

Ma.Re / Torii

cemento  
concrete  
béton  
Beton  
hormigón



Barbara



bianco  
white  
blanc  
Weiß  
blanco



Maria

bordeaux  
bordeaux  
bordeaux  
Bordeaux  
bordeaux

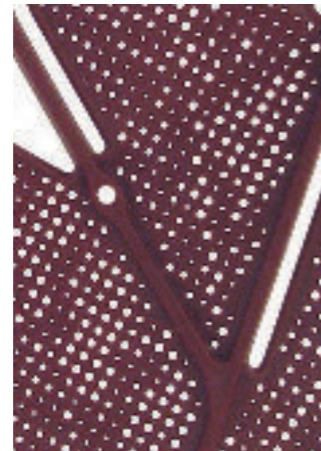

Maria

verde scuro  
dark green  
vert foncé  
Dunkelgrün  
verde oscuro

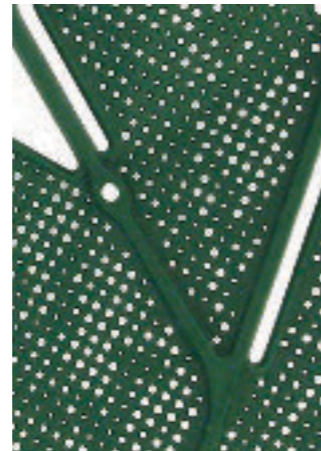

Maria

verde chiaro  
light green  
vert clair  
Lichtgrün  
verde claro



Maria

p. espanso nero  
expanded p. black  
p. expansé noir  
expandiertes P. Schwarz  
p. expandido negro



Opus Incertum

p. espanso bianco  
expanded p. white  
p. expansé blanc  
expandiertes P. Weiß  
p. expandido blanco

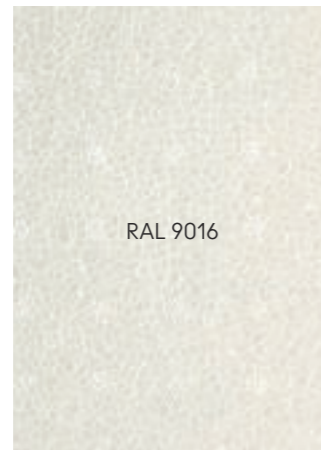

Opus Incertum

p. espanso polvere  
expanded p. dusty grey  
p. expansé gris poussière  
expandiertes P. Staubgrau  
p. expandido gris polvo



Opus Incertum

p. espanso beige  
expanded p. beige grey  
p. expansé gris beige  
expandiertes P. Beigegrau  
p. expandido gris beige



Opus Incertum

nero  
black  
noir  
Schwarz  
negro

Him & Her Lucida /  
Korzina / Zontik

bianco  
white  
blanc  
Weiß  
blanco

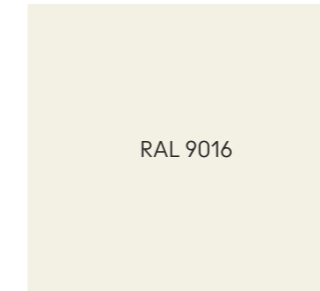

Him &amp; Her Lucida

polvere  
dusty grey  
gris poussière  
Staubgrau  
gris polvo

Him & Her Lucida /  
Korzina / Zontik

beige  
beige grey  
gris beige  
Beigegrau  
gris beige

Him & Her Lucida /  
Korzina / Zontik

rosso vino  
wine red  
rouge vin  
Weinrot  
rojo vino

Him & Her Lucida /  
Korzina / Zontik

grafite  
graphite  
graphite  
Graphit  
grafito

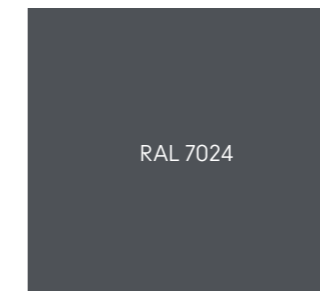

Him &amp; Her Lucida

oro perlato  
pearl gold  
or nacré  
Perlgold  
oro perlado



Him &amp; Her Lucida

rosso arancio chiaro  
bright red orange  
orangé rouge clair  
Hellrotorange  
rojo claro aranjado



Him &amp; Her Lucida

violetto perlato  
pearl violet  
violet nacré  
Perlviolett  
violeta perlado

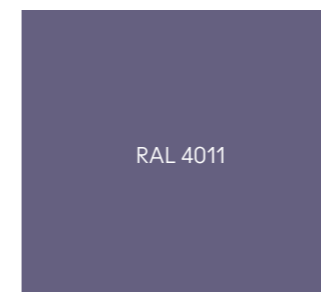

Him &amp; Her Lucida

blu oltremare  
ultramarine blu  
bleu outremer  
Ultramarinblau  
azul ultramar



Him &amp; Her Lucida

blu acqua  
water blue  
bleu d'eau  
Wasserblau  
azul agua

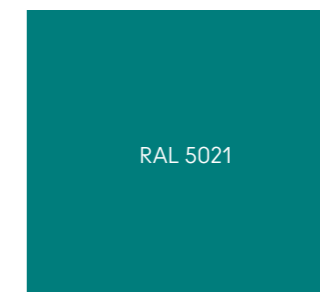

Him &amp; Her Lucida

blu notte perlato  
pearl night blue  
bleu nuit nacré  
Perlnachtblau  
azul noche perlado



Him &amp; Her Lucida

# Fenix, Rattan e Midollino

## / Fenix, Rattan and Natural Wicker

Fenix NTM® nero ingo 0720  
RAL Design 000 25 00  
Pantone P 179-16 C  
Ncs S 8500-N

Fenix NTM® bianco kos 0032  
RAL 9016  
Pantone P 1-9 C  
Ncs S 0500-N

Fenix NTA® Acciaio Hamilton  
Fenix NTA® Hamilton Steel  
Fenix NTA® Acier Hamilton  
Fenix NTA® Hamilton Stahl  
Fenix NTA® Acero Hamilton

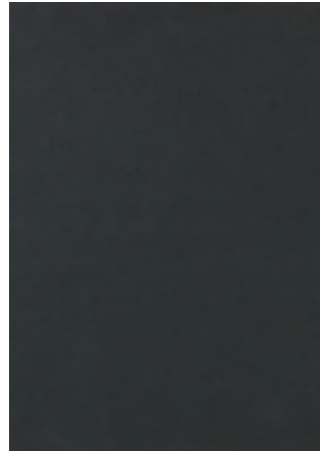

Bolero / Flower /  
Lazy Susan / Tango

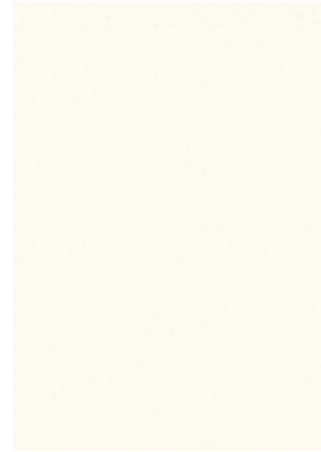

Bolero / Flower / Tango

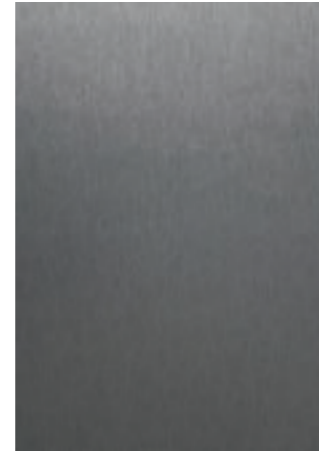

Bolero / Tango

midollino naturale  
natural wicker  
osier naturel  
Peddigrohr natur  
mimbre natural



Bar / Charlotte / Sin

rattan  
rattan  
rotin  
Rattan  
ratán



Raphia Rattan / Raphia Rocking

# Cuoio Pieno Fiore ed Ecopelle

## / Hard Leather Grade 1 and Faux Leather

cuoio pieno fiore naturale  
hard leather grade 1 natural  
cuir pleine fleur naturel  
Kernleder Natur  
cuero natural



Pablita / Tout le Jour

cuoio pieno fiore nero  
hard leather grade 1 black  
cuir pleine fleur noir  
Kernleder Schwarz  
cuero negro

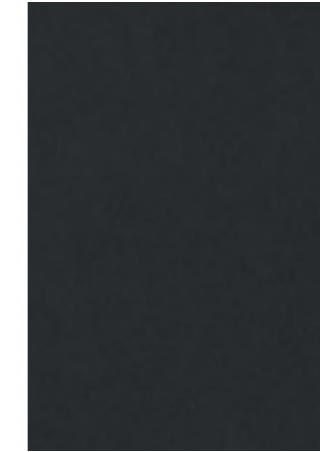

Pablita / Tout le Jour

cuoio pieno fiore grigio talpa  
hard leather grade 1 taupe  
cuir pleine fleur taupe  
Kernleder Taupe  
cuero gris raton

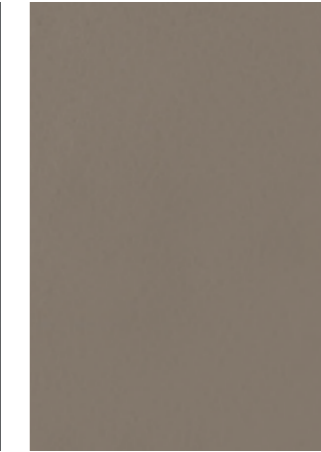

Pablita / Tout le Jour

cuoio pieno fiore testa di moro  
hard leather grade 1 brown  
cuir pleine fleur brun foncé  
Kernleder Dunkelbrown  
cuero testa di moro

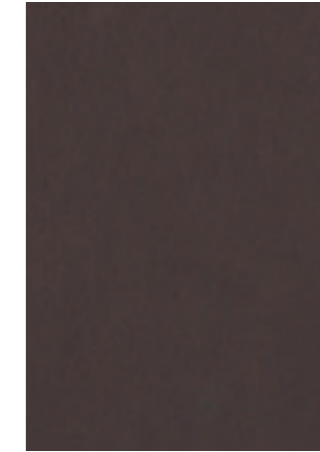

Pablita / Tout le Jour

Ecopelle  
Faux Leather  
Similcuir  
Kunstleder  
Ecopiel

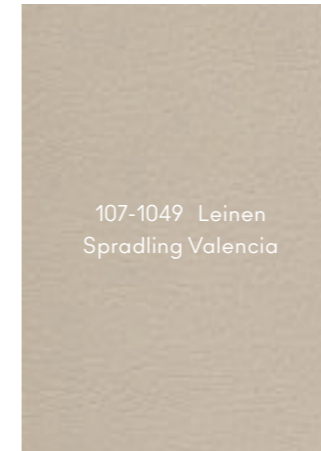

Network

Ecopelle  
Faux Leather  
Similcuir  
Kunstleder  
Ecopiel

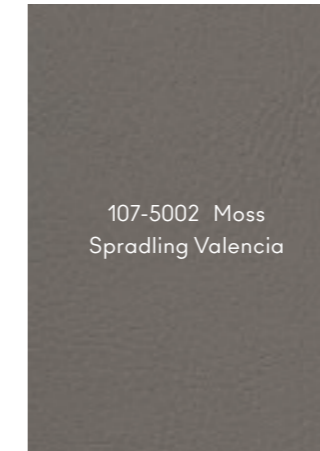

Network

Ecopelle  
Faux Leather  
Similcuir  
Kunstleder  
Ecopiel



Network

Ecopelle  
Faux Leather  
Similcuir  
Kunstleder  
Ecopiel



Network

nero  
black  
noir  
Schwarz  
negro

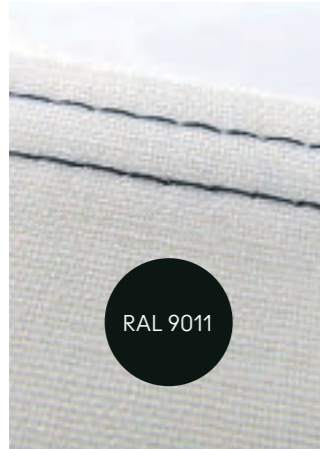

Lepel

bianco  
white  
blanc  
Weiß  
blanco

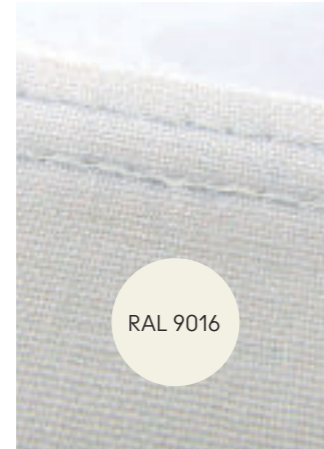

Lepel

polvere  
dusty grey  
gris poussière  
Staubgrau  
gris polvo

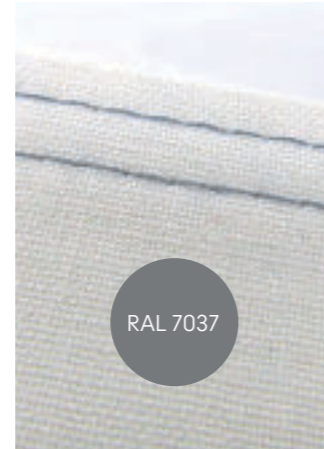

Lepel

giallo navone  
colza yellow  
jaune colza  
Rapsgelb  
amarillo colza



Lepel

rosso arancio chiaro  
bright red orange  
orangé rouge clair  
Hellrotorange  
rojo claro anaranjado



Lepel

rosso rubino  
ruby red  
rouge rubis  
Rubinrot  
rojo rubí



Lepel

rosa chiaro  
light pink  
rose clair  
Hellrosa  
rosa claro



Lepel

marrone noce  
nut brown  
brun noisette  
Nussbraun  
pardo nuez



Lepel

blu cobalto  
cobalt blue  
bleu cobalt  
Kobaltblau  
azul cobalto



Lepel

blu traffico  
traffic blue  
bleu signalisation  
Verkehrsblau  
azul tráfico



Lepel

verde brillante  
luminous green  
vert brillant  
Leuchtgrün  
verde brillante



Lepel

verde canna  
reed green  
vert jonc  
Schilfgrün  
verde caña



Lepel

lana lampone  
raspberry red wool  
laine rouge framboise  
Himbeerrot Wolle  
lana rojo frambuesa

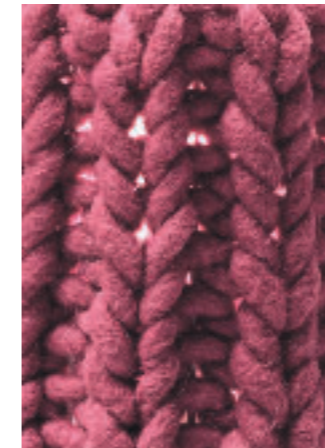

Granny

lana bianco ecrù  
pure white wool  
laine blanc pur  
Reinweiß Wolle  
lana blanco puro



Granny

lana grigio chiaro  
light grey wool  
laine gris clair  
Lichtgrau Wolle  
lana gris luminoso

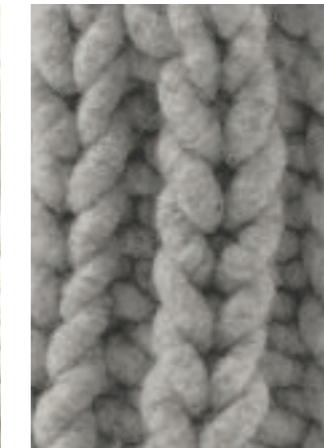

Granny

---

Schede tecniche  
Technical sheets  
Fiches techniques  
Technische Datenblätter  
Fichas técnicas

---

Outdoor protetto

Prodotto adatto ad ambienti esterni protetti (es. verande coperte). Non adatto ad ambienti con presenza di pioggia, nebbia, rugiada o umidità persistente. È necessario il ricovero in area chiusa durante la notte. I prodotti realizzati con materiali naturali sono comunque soggetti a deterioramento.

Protected outdoor

Protected product suitable for protected outdoor areas (e.g. covered verandas). Not suitable for environments with rain, fog, dew or persistent humidity. Shelter in a closed area is necessary overnight. Products made from natural materials are however subject to deterioration.

Outdoor protégé

Produit adapté aux extérieurs protégés (par ex. vérandas couvertes). Ne convient pas aux environnements avec pluie, brouillard, rosée ou humidité persistante. Il est nécessaire de le rentrer dans une zone fermée pendant la nuit. Les produits fabriqués à partir de matériaux naturels peuvent, quoi qu'il en soit, se détériorer.

Geschützte Außenbereiche

Produkt, geeignet für geschützte Außenbereiche. Nicht geeignet für Umgebungen, die anhaltendem Regen, Nebel, Tau oder Feuchtigkeit ausgesetzt sind. Für die Nacht muss das Produkt in einen geschlossenen Bereich verlegt werden. Natürlichen Materialien unterliegen der Gefahr beschädigt zu werden.

Outdoor protegido

Producto apto para espacios externos protegidos (p. ej., verandas cubiertas). No apto para entornos con lluvia, niebla, rocío o humedad persistentes. Debe conservarse en lugar cerrado durante la noche. En todo caso, los productos realizados con materiales naturales están sujetos a deterioro.

Pioggia

Prodotto adatto ad ambienti esterni con precipitazioni atmosferiche normali. In caso di pioggia persistente è necessario il ricovero in area protetta. I prodotti realizzati con materiali naturali sono comunque soggetti a deterioramento.

Rain

Product suitable for outdoor environments with normal atmospheric precipitation. In case of persistent rain, shelter in a protected area is necessary. Products made from natural materials are however subject to deterioration.

Pluie

Produit adapté aux environnements extérieurs avec précipitations atmosphériques normales. En cas de pluie persistante, il est nécessaire de le rentrer dans une zone protégée. Les matériaux naturels peuvent, quoi qu'il en soit, se détériorer.

Regen

Das Produkt ist für Außenbereiche mit normalem Niederschlag geeignet. Bei anhaltendem Regen ist es notwendig, das Produkt in einen geschützten Bereich zu verlegen. Natürlichen Materialien unterliegen der Gefahr beschädigt zu werden.

Lluvia

Producto apto para espacios externos con precipitaciones normales. En caso de lluvia persistente se debe conservar en un área protegida. En todo caso, los productos realizados con materiales naturales están sujetos a deterioro.

Salsedine

Prodotto adatto ad aree marittime o con presenza di nebbia salina. Lavare frequentemente.

Seaside

Product suitable for sea areas or with salt spray. Wash frequently.

Bord de mer

Produit adapté aux zones maritimes ou en présence de brouillard salin. Laver fréquemment.

Am Meer

Für die Verwendung in Meernähe oder in Salznebel ausgesetzten Bereiche geeignet. Häufig waschen.

Orilla del mar

Producto apto para áreas marítimas con presencia de nieblas salinas. Lavar con frecuencia.

Impilabile

Prodotto realizzato per poter essere impilato.

Stackable

Product designed to be stacked.

Empilable

Produit conçu pour être empilé.

Stapelbar

Das Produkt ist zum Stapeln geeignet.

Apilable

Producto diseñado para ser apilado.

Basamento metallico per madie e cassettiere

Metal bases for sideboards and chest of drawers

Pieds métalliques pour buffets et commodes

Metallbasis für Sideboards und Schubladenelementen

Patas metálicas para aparadores y cajoneras

Minimal Design (MD)

> metallo  
nero  
bianco

Minimal Design (MD)

> metal  
black  
white

Minimal Design (MD)

> métal  
noir  
blanc

Minimal Design (MD)

> Metall  
Schwarz  
Weiß

Minimal Design (MD)

> metal  
negro  
blanco

Mid-Century Modern (MCM)

> metallo brunito

Mid-Century Modern (MCM)

> burnished metal

Mid-Century Modern (MCM)

> metal bruni

Mid-Century Modern (MCM)

> brüniertes Metall

Mid-Century Modern (MCM)

> metal bruñido

	Madie o cassettiere Sideboards or chests of drawers Buffets ou commodes Sideboards oder Schubladen Aparadores o cajoneras	Lunghezza del mobile Storage unit length Longueur de meuble Behälter Länge Longitud del mueble
H 16 cm / 6.3"	Anish / ComRì / Polka Dots	128 cm / 50.4"
 MD	Carlos / Leon / Spectro	144 cm / 56.7"
 MCM	Anish / Carlos / ComRì / Leon / Not Riddled Polka Dots / Riddled Front / Spectro / Tide	192 cm / 75.6"
	Carlos / Leon / Spectro / Tide	240 cm / 94.5"

H 32 cm / 12.6"	Anish / ComRì / Polka Dots	128 cm / 50.4"
 MD	Carlos / Leon / Spectro	144 cm / 56.7"
	Anish / Carlos / ComRì / Leon / Not Riddled Polka Dots / Riddled Front / Spectro / Tide	192 cm / 75.6"
	Carlos / Leon / Spectro / Tide	240 cm / 94.6"

Ripiani

› laccato lucido  
o laccato opaco  
nero  
bianco  
polvere  
beige  
rosso vino  
bruno  
grafite

Shelves

› glossy lacquered  
or matt lacquered  
black  
white  
dusty grey  
beige grey  
wine red  
brown grey  
graphite

Étagères

› laqué brillant  
ou laqué mat  
noir  
blanc  
gris poussière  
gris beige  
rouge vin  
gris brun  
graphite

Einlegenböden

› glänzend lackiert  
oder matt lackiert  
Schwarz  
Weiß  
Staubgrau  
Beigegrau  
Weinrot  
Braungrau  
Graphit

Estantes

› lacado brillante  
o lacado opaco  
negro  
blanco  
gris polvo  
gris beige  
rojo vino  
gris parduzco  
grafito

Montanti

› noce canaletto  
massello

Uprights

› solid walnut

Montants

› noyer massif

Pfosten

› Massiv Nussholz

Montantes

› nogal macizo

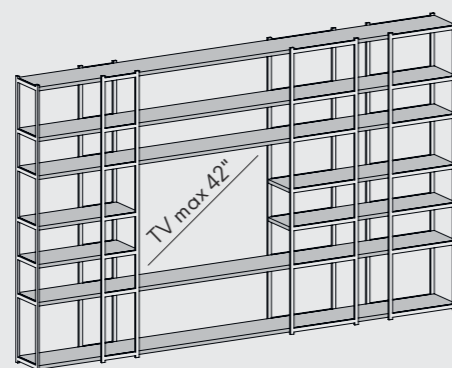
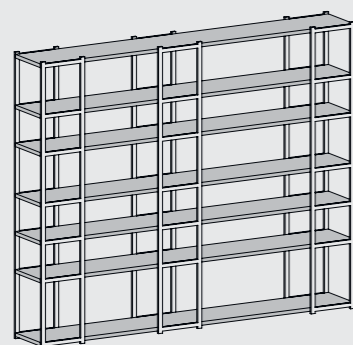
Esempidi composizioneExamplesof compositionExemplesde compositionBeispielevon KompositionEjemplosde composiciónProfondità

› 34.5 cm

Depth

› 34.5 cm / 13.5"

Profondeur

› 34.5 cm

Tiefe

› 34.5 cm

Profundidad

› 34.5 cm

Altezza

› 218 cm

Height

› 218 cm / 85.8"

Hauteur

› 218 cm

Hohe

› 218 cm

Altura

› 218 cm

Modularità

La libreria può avere infinite combinazioni considerando i seguenti moduli:  
› 26 cm  
› 32 cm  
› 52 cm  
› 57.5 cm  
› 64 cm  
› 80 cm  
› 128 cm (porta TV)

Modularity

The library can have endless combinations considering the following modules:  
› 26 cm / 10.2"  
› 32 cm / 12.6"  
› 52 cm / 20.5"  
› 57.5 cm / 22.6"  
› 64 cm / 25.2"  
› 80 cm / 31.5"  
› 128 cm / 50.4" (TV stand)

Modularité

La bibliothèque peut avoir multiple combinaisons en utilisant les modules suivants:  
› 26 cm  
› 32 cm  
› 52 cm  
› 57.5 cm  
› 64 cm  
› 80 cm  
› 128 cm (meubles TV)

Modulbauweise

Das Bücherregale kann viele Kombinationen haben, wenn man die folgenden Module betrachtet:  
› 26 cm  
› 32 cm  
› 52 cm  
› 57.5 cm  
› 64 cm  
› 80 cm  
› 128 cm (TV-Träger)

Modularidad

La biblioteca puede tener múltiples combinaciones utilizando los siguientes módulos:  
› 26 cm  
› 32 cm  
› 52 cm  
› 57.5 cm  
› 64 cm  
› 80 cm  
› 128 cm (muebles TV)

Per maggiori informazioni vedere listino.

For more info, please see price list.

Pour plus d'informations, voir la liste des prix.

Weitere Infos in der Preisliste

Para más información, consulte la tarifa.

Struttura

› metallo  
bianco  
beige

Structure

› metal  
white  
beige grey

Structure

› métal  
blanc  
gris beige

Struktur

› Metall  
Weiß  
Beigegrau

Estructura

› metal  
blanco  
gris beige

Nota

Gli elementi possono essere appoggiati a terra o fissati a parete. Il pannello di fondo nasconde le viti di fissaggio.

Notice

The elements can be placed on the ground or fixed to the wall. The bottom panel hides the fixing screws.

Avertissement

Les éléments peuvent être posés au sol ou fixés au mur. Le panneau inférieur cache les vis de fixation.

Anmerkungen

Die Elemente können auf dem Boden oder an der Wand befestigt werden. Die Bödenplatte versteckt die Schrauben.

Aviso

Los elementos pueden colocarse en el suelo o fijarse a la pared. El panel inferior oculta los tornillos de fijación.

Small  
40  
15.7"  
20  
7.9"

Medium  
60  
23.6"  
20  
7.9"

Large  
40  
15.7"  
40  
15.7"

Profondità

› 30 cm  
› 20 cm

Depth

› 30 cm / 11.8"  
› 20 cm / 17.9"

Profondeur

› 30 cm  
› 20 cm

Tiefe

› 30 cm  
› 20 cm

Profundidad

› 30 cm  
› 20 cm

<u>Scocca</u> › laccato lucido o laccato opaco nero bianco polvere beige rosso vino bruno grafite	<u>Body</u> › glossy lacquered or matt lacquered black white dusty grey beige grey wine red brown grey graphite	<u>Corps</u> › laqué brillant ou laqué mat noir blanc gris poussière gris beige rouge vin gris brun graphite	<u>Korpus</u> › glänzend lackiert oder matt lackiert Schwarz Weiß Staubgrau Beigegrau Weinrot Braungrau Graphit	<u>Cuerpo</u> › lacado brillante o lacado opaco negro blanco gris polvo gris beige rojo vino gris parduzco grafito
› faggio moca	› mocha beech	› hêtre moka	› Buche Mokka	› haya moca
<u>Frontale cassetti</u> › laccato lucido o laccato opaco nero bianco polvere beige rosso vino bruno grafite	<u>Front drawers</u> › glossy lacquered or matt lacquered black white dusty grey beige grey wine red brown grey graphite	<u>Façade de tiroirs</u> › laqué brillant ou laqué mat noir blanc gris poussière gris beige rouge vin gris brun graphite	<u>Schubladenfront</u> › glänzend lackiert oder matt lackiert Schwarz Weiß Staubgrau Beigegrau Weinrot Braungrau Graphit	<u>Frontal de cajones</u> › lacado brillante o lacado opaco negro blanco gris gris beige rojo vino gris parduzco grafito
› noce canaletto	› walnut	› noyer	› Nussbaum	› nogal
<u>Fianco cassetti</u> › alluminio	<u>Drawer sides</u> › aluminium	<u>Côté des tiroirs</u> › aluminium	<u>Schubladenseite</u> › Aluminium	<u>Laterales de cajones</u> › aluminio
<u>Optional</u> › basamenti MCM (H16 cm) MD (H16 / H32 cm)	<u>Optional</u> › metal bases MCM (H16 cm) MD (H16 / H32 cm)	<u>Optionnel</u> › pieds métalliques MCM (H16 cm) MD (H16 / H32 cm)	<u>Optional</u> › Metallbasis MCM (H16 cm) MD (H16 / H32 cm)	<u>Opcional</u> › patas metálicas MCM (H16 cm) MD (H16 / H32 cm)
<u>Nota</u> Di serie piedini H2 cm regolabili.	<u>Notice</u> Adjustable H2 cm feet as standard.	<u>Avertissement</u> Pieds réglables H2 cm en standard.	<u>Anmerkungen</u> Regulierbare Standardfüße H2cm.	<u>Aviso</u> Pies regulables de H2 cm de serie.



<u>Profondità</u> › 50 cm	<u>Depth</u> › 50 cm / 19.7"	<u>Profondeur</u> › 50 cm	<u>Tiefe</u> › 50 cm	<u>Profundidad</u> › 50 cm
------------------------------	---------------------------------	------------------------------	-------------------------	-------------------------------

<u>Scocca</u> › laccato lucido o laccato opaco nero bianco polvere beige rosso vino bruno grafite	<u>Body</u> › glossy lacquered or matt lacquered black white dusty grey beige grey wine red brown grey graphite	<u>Corps</u> › laqué brillant ou laqué mat noir blanc gris poussière gris beige rouge vin gris brun graphite	<u>Korpus</u> › glänzend lackiert oder matt lackiert Schwarz Weiß Staubgrau Beigegrau Weinrot Braungrau Graphit	<u>Cuerpo</u> › lacado brillante o lacado opaco negro blanco gris polvo gris beige rojo vino gris parduzco grafito
› faggio moca	› mocha beech	› hêtre moka	› Buche Mokka	› haya moca
<u>Ante</u> › laccato lucido o laccato opaco nero bianco polvere beige rosso vino bruno grafite	<u>Doors</u> › glossy lacquered or matt lacquered black white dusty grey beige grey wine red brown grey graphite	<u>Portes</u> › laqué brillant ou laqué mat noir blanc gris poussière gris beige rouge vin gris brun graphite	<u>Türen</u> › glänzend lackiert oder matt lackiert Schwarz Weiß Staubgrau Beigegrau Weinrot Braungrau Graphit	<u>Puertas</u> › lacado brillante o lacado opaco negro blanco gris polvo gris beige rojo vino gris parduzco grafito
› noce canaletto	› walnut	› noyer	› Nussbaum	› nogal
<u>Optional</u> › ripiani in legno	<u>Optional</u> › wooden shelves	<u>Optionnel</u> › étagères en bois	<u>Optional</u> › Holzregale	<u>Opcional</u> › baldas de madera
› basamenti MCM (H16 cm) MD (H16 / H32 cm)	› metal bases MCM (H16 cm) MD (H16 / H32 cm)	› pieds métalliques MCM (H16 cm) MD (H16 / H32 cm)	› Metallbasis MCM (H16 cm) MD (H16 / H32 cm)	› patas metálicas MCM (H16 cm) MD (H16 / H32 cm)
<u>Nota</u> Di serie ripiani in vetro temperato e piedini H2 cm regolabili.	<u>Notice</u> Tempered glass shelves and adjustable H2 cm feet as standard.	<u>Avertissement</u> Étagères en verre trempé et pieds réglables H2 cm en standard.	<u>Anmerkungen</u> Standard Temperglasregale und regulierbare Standardfüße H2cm.	<u>Aviso</u> Baldas de cristal templado y pies de H2 cm regulables de serie.

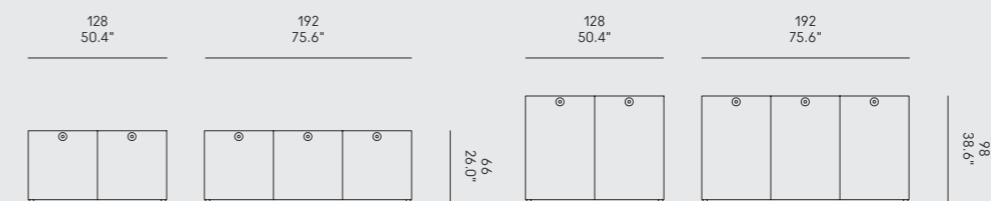

<u>Profondità</u> › 50 cm	<u>Depth</u> › 50 cm / 19.7"	<u>Profondeur</u> › 50 cm	<u>Tiefe</u> › 50 cm	<u>Profundidad</u> › 50 cm
------------------------------	---------------------------------	------------------------------	-------------------------	-------------------------------

Scocca e ripiani  
› metallo nero

Body and shelver  
› black metal

Corps et étagères  
› métal noir

Korpus und Böden  
› schwarzes Metall

Cuerpo y estantes  
› metal negro

Cornice  
› alluminio anodizzato

Frame  
› anodized aluminium

Cadre  
› aluminium anodisé

Rahmen  
› eloxiertes Aluminium

Marco  
› aluminio anodizado

Nota  
Montaggio a parete. Specchio con pellicola anti-infortunistica. Lo specchio è fisso. Un contenitore alle spalle dello specchio scorre esternamente a destra e a sinistra.

Notice  
Wall mounting. Mirror with safety film. Mirror is fixed. A container behind the mirror slides externally to the right and left.

Avertissement  
Montage mural. Miroir avec film de sécurité. Le miroir est fixe. Un conteneur derrière le miroir glisse vers l'extérieur à droite et à gauche.

Anmerkungen  
Wandmontage. Spiegel mit Sicherheitsfolie. Der Spiegel ist fixiert. Ein Behälter hinter dem Spiegel gleitet außen nach rechts und links.

Aviso  
Montaje a la pared. Espejo con película de seguridad. El espejo queda fijo. Un contenedor detrás del espejo se desliza externamente a la derecha y a la izquierda.

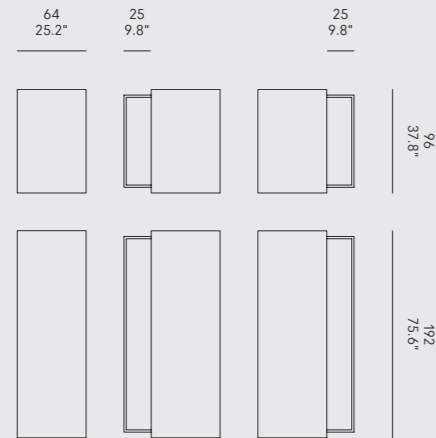

Profondità  
› 17 cm

Depth  
› 17 cm / 6.7"

Profondeur  
› 17 cm

Tiefe  
› 17 cm

Profundidad  
› 17 cm

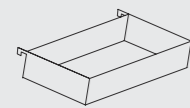

Ripiani dritti portaoggetti

Straight storage shelves

Étagères de rangement droites

Einlegeböden für die Lagerung

Repisas horizontales porta objetos

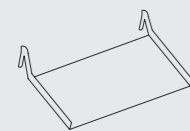

Ripiani inclinati per uso scarpiera

Inclined shelves for shoe rack use

Tablettes inclinées pour étagères à chaussures

Schrägbödenregale für Schuhe

Repisas inclinadas para zapatos

Scocca  
› laccato lucido o laccato opaco  
nero  
bianco  
polvere  
beige  
rosso vino  
bruno  
grafite

Body  
› glossy lacquered or matt lacquered  
black  
white  
dusty grey  
beige grey  
wine red  
brown grey  
graphite

Corps  
› laqué brillant ou laqué mat  
noir  
blanc  
gris poussière  
gris beige  
rouge vin  
gris brun  
graphite

› Korpus  
› glänzend lackiert oder matt lackiert  
Schwarz  
Weiß  
Staubgrau  
Beigegrü  
Weinrot  
Braungrü  
Graphit

Cuerpo  
› lacado brillante o lacado opaco  
negro  
blanco  
gris polvo  
beige  
rojo vino  
gris parduzco  
grafito

Nota  
Disponibile nelle versioni:  
› credenza (A)  
› armadio con ripiani (B)  
› armadio con bastone appendiabiti illuminato (C)

Notice  
Available in the following versions:  
› cupboard (A)  
› wardrobe with shelves (B)  
› wardrobe with illuminated clothes rail (C)

Avertissement  
Disponible en version:  
› buffet (A)  
› armoire avec étagères (B)  
› armoire avec tringle à linge éclairée (C)

Anmerkungen  
Erhältlich in die Versionen:  
› Kredenz (A)  
› Regalschrank (B)  
› Schrank mit beleuchteter Kleiderstange (C)

Aviso  
Disponible en versiones:  
› alacena (A)  
› armario con baldas (B)  
› armario con barra de confección iluminada (C)

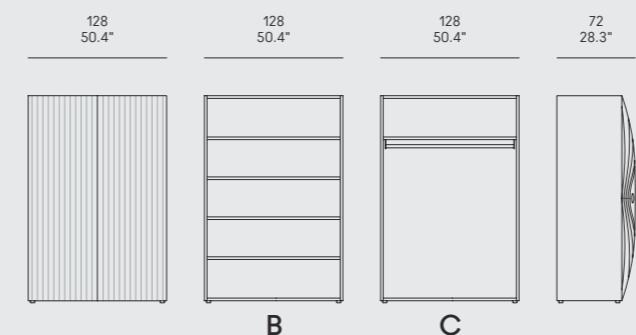
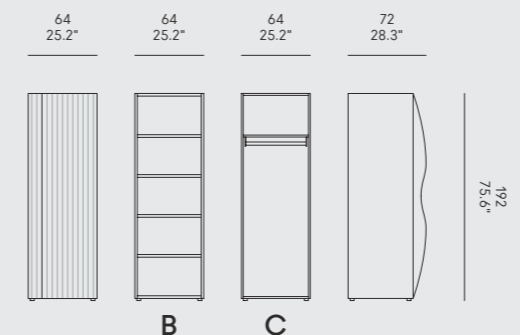
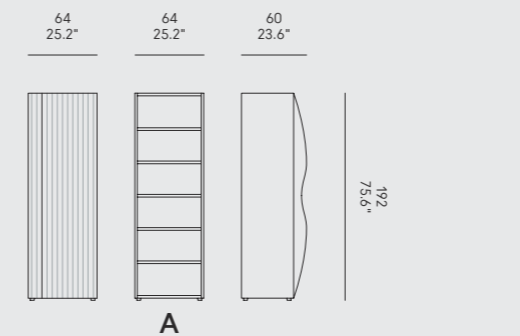



<u>Scocca</u> > laccato opaco o lucido bianco  > faggio moca	<u>Body</u> > white matt or glossy lacquered  > mocha beech	<u>Corps</u> > laqué mat ou brillant blanc  > hêtre moka	<u>Korpus</u> > weiß matt oder glänzend lackiert  > Buche Mokka	<u>Cuerpo</u> > lacado brillante o opaco blanco  > haya moca
<u>Ante</u> > rovere termotrattato e HPL bianco	<u>Doors</u> > thermo-treated oak and white HPL	<u>Portes</u> > chêne thermotraité et HPL blanc	<u>Türen</u> > wärmebehandelte Eiche und HPL Weiß	<u>Puertas</u> > roble termotrattato y HPL blanco
<u>Optional</u> > ripiani in legno  > basamenti MCM (H16 cm) MD (H16 / H32 cm)	<u>Optional</u> > wooden shelves  > metal bases MCM (H16 cm) MD (H16 / H32 cm)	<u>Optionnel</u> > étagères en bois  > pieds métalliques MCM (H16 cm) MD (H16 / H32 cm)	<u>Optional</u> > Holzregale  > Metallbasis MCM (H16 cm) MD (H16 / H32 cm)	<u>Opcional</u> > baldas de madera  > patas metálicas MCM (H16 cm) MD (H16 / H32 cm)
<u>Nota</u> Di serie ripiani in vetro temperato e piedini H2 cm regolabili.	<u>Notice</u> Tempered glass shelves and adjustable H2 cm feet as standard.	<u>Avertissement</u> Étagères en verre trempé et pieds réglables H2 cm en standard.	<u>Anmerkungen</u> Standard Temperglasregale und regulierbare Standardfüße H2 cm.	<u>Aviso</u> Baldas de cristal templado y pies de H2 cm regulables de serie.

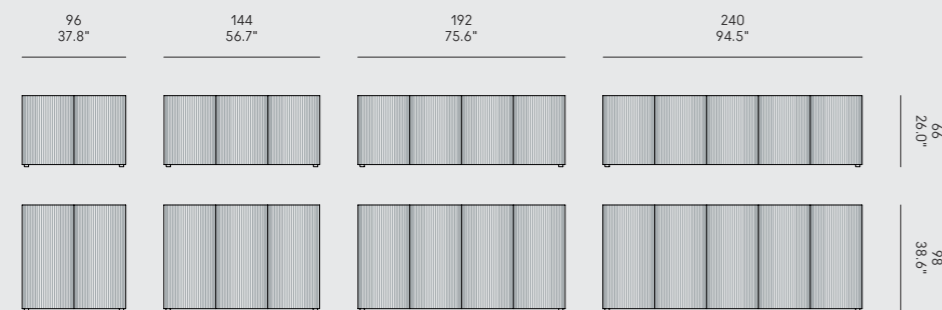

<u>Profondità</u> > 49 cm	<u>Depth</u> > 49 cm / 19.3"	<u>Profondeur</u> > 49 cm	<u>Tiefe</u> > 49 cm	<u>Profundidad</u> > 49 cm
------------------------------	---------------------------------	------------------------------	-------------------------	-------------------------------

<u>Struttura e frontali</u> > laccato lucido o laccato opaco nero bianco polvere beige rosso vino bruno grafite	<u>Structure and front</u> > glossy lacquered or matt lacquered black white dusty grey beige grey wine red brown grey graphite	<u>Structure et façades</u> > laqué brillant ou laqué mat noir blanc gris poussière gris beige rouge vin gris brun graphite	<u>Korpus und Front</u> > glänzend lackiert oder matt lackiert Schwarz Weiß Staubgrau Beigegrü Weinrot Braungrü Graphit	<u>Estructura y frontal</u> > lacado brillante o lacado opaco negro blanco gris polvo gris beige rojo vino gris parduzco grafito
<u>Portagioie</u> > multistrato in noce canaletto, mogano, ciliegio, rovere e frassino	<u>Jewelry drawer</u> > walnut, mahogany, cherry, oak and ash plywood	<u>Porte-bijoux</u> > contre-plaquè en noyer, acajou, cerisier, chêne et frêne	<u>Schmuckkästen</u> > Multiplex aus Nussbaum, Mahagoni, Kirsche, Eiche und Esche	<u>Portajoyas</u> > multicapas en nogal, caoba, cerezo, roble y fresno
<u>Fianco cassetti</u> > alluminio	<u>Drawer sides</u> > aluminium	<u>Côté des tiroirs</u> > aluminium	<u>Schubladenseite</u> > Aluminium	<u>Laterales de cajones</u> > aluminio
<u>Optional</u> > basamenti MCM (H16 cm) MD (H16 / H32 cm)	<u>Optional</u> > metal bases MCM (H16 cm) MD (H16 / H32 cm)	<u>Optionnel</u> > pieds métalliques MCM (H16 cm) MD (H16 / H32 cm)	<u>Optional</u> > Metallbasis MCM (H16 cm) MD (H16 / H32 cm)	<u>Opcional</u> > patas metálicas MCM (H16 cm) MD (H16 / H32 cm)
<u>Nota</u> Di serie piedini H2 cm regolabili.	<u>Notice</u> Adjustable H2 cm feet as standard.	<u>Avertissement</u> Pieds réglables H2 cm en standard.	<u>Anmerkungen</u> Regulierbare Standardfüße H2cm.	<u>Aviso</u> Pies regulables de H2 cm de serie.

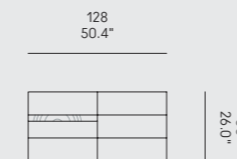

Disponibile con  
3 cassetti + 1 anta  
oppure 6 cassetti.

Available with  
3 drawers + 1 door  
or 6 drawers.

Disponibile avec  
3 tiroirs + 1 porte  
ou 6 tiroirs.

Mit 3 Schubladen + 1 Tür  
oder mit 6 Schubladen  
erhältlich.

Disponibile con  
3 cajones + 1 puerta  
o 6 cajones.

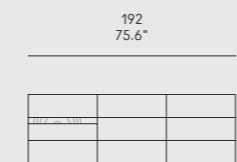

Disponibile con  
3 cassetti + 2 ante  
o 6 cassetti + 1 anta.

Available with  
3 drawers + 2 doors  
or 6 drawers + 1 door.

Disponibile avec  
3 tiroirs + 2 portes  
ou 6 tiroirs + 1 porte.

Mit 3 Schubladen + 2 Türen  
oder mit 6 Schubladen  
+ 1 Tür erhältlich.

Disponibile con  
3 cajones + 2 puertas  
o 6 cajones + 1 puerta.

<u>Profondità</u> > 50 cm	<u>Depth</u> > 50 cm / 19.7"	<u>Profondeur</u> > 50 cm	<u>Tiefe</u> > 50 cm	<u>Profundidad</u> > 50 cm
------------------------------	---------------------------------	------------------------------	-------------------------	-------------------------------

<u>Montanti</u> > metallo nero bianco	<u>Uprights</u> > metal black white	<u>Montants</u> > métal noir blanc	<u>Pfosten</u> > Metall Schwarz Weiß	<u>Montantes</u> > metal negro blanco
<u>Piedini e supporti</u> > plastica nero bianco	<u>Feet and supports</u> > plastic black white	<u>Pieds et supports</u> > plastique noir blanc	<u>Füße und Stützen</u> > Kunststoff Schwarz Weiß	<u>Pies y soportes</u> > plástico negro blanco
<u>Ripiani e contenitori</u> > melaminico bianco noce	<u>Shelves, cabinets and chest of drawers</u> > melamine white walnut	<u>Étagères et meubles de rangement</u> > mélamine blanc noyer	<u>Einlegenböden und Behälter</u> > Melamin Weiß Nussbaum	<u>Estantes y contenedores</u> > melamina blanco nogal

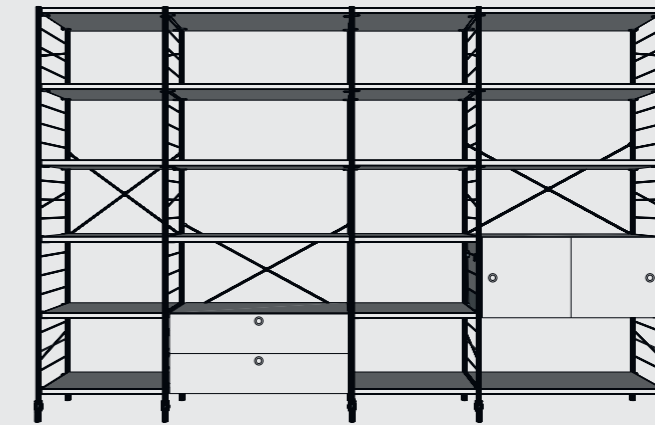

Esempio di composizione

Example of composition

Exemple de composition

Beispiel von Komposition

Ejemplo de composición

Profondità  
> 33.5 cm

Depth  
> 33.5 cm / 13.2"

Profondeur  
> 33.5 cm

Tiefe  
> 33.5 cm

Profundidad  
> 33.5 cm

Altezza  
> 77 cm  
> 125 cm  
> 163.5 cm  
> 202 cm

Height  
> 77 cm / 30.3"  
> 125 cm / 49.2"  
> 163.5 cm / 64.4"  
> 202 cm / 79.5"

Hauteur  
> 77 cm  
> 125 cm  
> 163.5 cm  
> 202 cm

Hohe  
> 77 cm  
> 125 cm  
> 163.5 cm  
> 202 cm

Altura  
> 77 cm  
> 125 cm  
> 163.5 cm  
> 202 cm

Modularità  
La libreria può avere infinite combinazioni considerando i seguenti moduli:  
> 60 cm  
> 90 cm

Modularity  
The library can have endless combinations considering the following modules:  
> 60 cm / 23.6"  
> 90 cm / 35.4"

Modularité  
La bibliothèque peut avoir multiple combinaisons en utilisant les modules suivants:  
> 60 cm  
> 90 cm

Modulbauweise  
Das Bücherregal kann viele Kombinationen haben, wenn man die folgenden Module betrachtet:  
> 60 cm  
> 90 cm

Modularità  
La biblioteca puede tener múltiples combinaciones utilizando los siguientes módulos:  
> 60 cm  
> 90 cm

Per maggiori informazioni vedere listino.

For more info, please see price list.

Pour plus d'informations, voir la liste des prix.

Weitere Infos in der Preisliste.

Para más información, consulte la tarifa.

<u>Montanti e accessori</u>	<u>Uprights and accessories</u>	<u>Montants et accessoires</u>	<u>Pfosten und Zubehör</u>	<u>Montantes y accesorios</u>
> metallo bianco grigio	> metal white grey	> métal blanc gris	> Metall Weiß grau	> metal blanco gris
<u>Piedini e supporti</u>	<u>Feet and supports</u>	<u>Pieds et supports</u>	<u>Füße und Stützen</u>	<u>Pies y soportes</u>
> plastica trasparente	> transparent plastic	> plastique transparent	> transparenter Kunststoff	> plástico transparente
<u>Ripiani e contenitori</u>	<u>Shelves, cabinets and chest of drawers</u>	<u>Étagères et meubles de rangement</u>	<u>Einlegenböden und Behälter</u>	<u>Estantes y contenedores</u>
> melaminico bianco grigio	> melamine white grey	> mélamine blanc gris	> Melamin Weiß Grau	> melaminico blanco gris
> lamiera di metallo microforato bianco grigio	> microperforated metal sheet white grey	> tôle microperforée blanc gris	> mikroperforierte Blech Weiß grau	> lámina de metal microperforada blanco gris

Esempio di composizione

Example of composition

Exemple de composition

Beispiel von Komposition

Ejemplo de composición

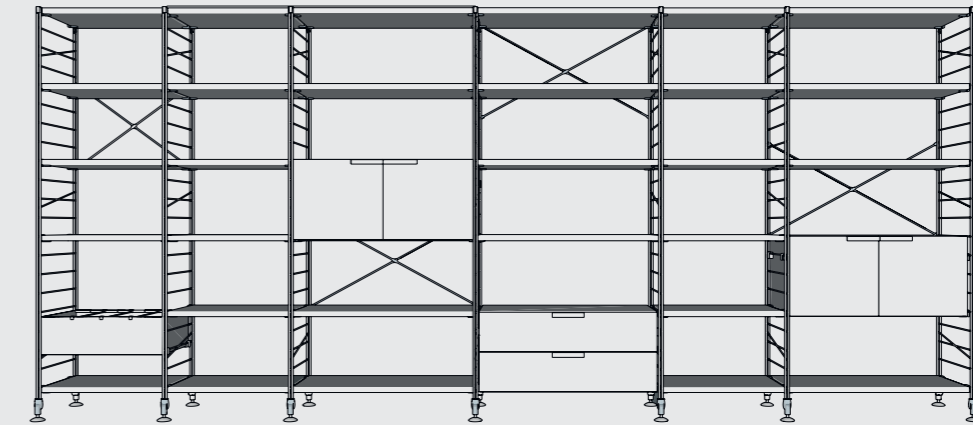

Profondità

> 27 cm  
> 33.5 cm  
> 45.5 cm  
> 54 cm bifrontale

Depth

> 127 cm / 0.6"  
> 33.5 cm / 13.2"  
> 45.5 cm / 17.9"  
> 54 cm / 21.3" two-sided

Profondeur

> 27 cm  
> 33.5 cm  
> 45.5 cm  
> 54 cm double-face

Tiefe

> 27 cm  
> 33.5 cm  
> 45.5 cm  
> 54 cm doppelseitig

Profundidad

> 27 cm  
> 33.5 cm  
> 45.5 cm  
> 54 cm bifrontal

Altezza

> 84 cm  
> 132 cm  
> 170 cm  
> 209 cm  
> 247 cm

Height

> 84 cm / 33.0"  
> 132 cm / 51.9"  
> 170 cm / 66.9"  
> 209 cm / 82.3"  
> 247 cm / 97.2"

Hauteur

> 84 cm  
> 132 cm  
> 170 cm  
> 209 cm  
> 247 cm

Hohe

> 84 cm  
> 132 cm  
> 170 cm  
> 209 cm  
> 247 cm

Altura

> 84 cm  
> 132 cm  
> 170 cm  
> 209 cm  
> 247 cm

Modularità

La libreria può avere infinite combinazioni considerando i seguenti moduli:  
> 60 cm  
> 90 cm

Modularity

The library can have endless combinations considering the following modules:  
> 60 cm / 23.6"  
> 90 cm / 35.4"

Modularité

La bibliothèque peut avoir multiple combinaisons en utilisant les modules suivants:  
> 60 cm  
> 90 cm

Modulbauweise

Das Bücherregal kann viele Kombinationen haben, wenn man die folgenden Module betrachtet:  
> 60 cm  
> 90 cm

Modularidad

La biblioteca puede tener múltiples combinaciones utilizando los siguientes módulos:  
> 60 cm  
> 90 cm

Per maggiori informazioni vedere listino.

For more info, please see price list.

Pour plus d'informations, voir la liste des prix.

Weitere Infos in der Preisliste.

Para más información, consulte la tarifa.

<b>Finitura</b> > laccato lucido o laccato opaco nero bianco polvere beige rosso vino bruno grafite	<b>Finish</b> > glossy lacquered or matt lacquered black white dusty grey beige grey wine red brown grey graphite	<b>Finition</b> > laqué brillant ou laqué mat noir blanc gris poussière gris beige rouge vin gris brun graphite	<b>Ausführung</b> > glänzend lackiert oder matt lackiert Schwarz Weiß Staubgrau Beigegrau Weinrot Braungrau Graphit	<b>Acabado</b> > lacado brillante o lacado opaco negro blanco gris polvo gris beige rojo vino gris parduzco grafito
<b>Decor verticali</b> > rovere naturale > noce canaletto	<b>Vertical decorations</b> > natural oak > walnut	<b>Decorations verticaux</b> > chêne naturel > noyer	<b>Vertikale Dekorationen</b> > Eiche Natur > Nussbaum	<b>Decoraciones verticales</b> > roble natural > nogal
<b>Optional</b> > ripiani in legno	<b>Optional</b> > wooden shelves	<b>Optionnel</b> > étagères en bois	<b>Optional</b> > Holzregale	<b>Opcional</b> > baldas de madera
> basamenti MCM (H16 cm) MD (H16 / H32 cm)	> metal bases MCM (H16 cm) MD (H16 / H32 cm)	> pieds métalliques MCM (H16 cm) MD (H16 / H32 cm)	> Metallbasis MCM (H16 cm) MD (H16 / H32 cm)	> patas metálicas MCM (H16 cm) MD (H16 / H32 cm)
<b>Nota</b> Di serie ripiani in vetro temperato e piedini H2 cm regolabili.	<b>Notice</b> Tempered glass shelves and adjustable H2 cm feet as standard.	<b>Avertissement</b> Étagères en verre trempé et pieds réglables H2 cm en standard.	<b>Anmerkungen</b> Standard Temperglasregale und regulierbare Standardfüße H2cm.	<b>Aviso</b> Baldas de cristal templado y pies de H2 cm regulables de serie.

<b>Finitura</b> > laccato lucido o laccato opaco nero bianco polvere beige rosso vino bruno grafite	<b>Finish</b> > glossy lacquered or matt lacquered black white dusty grey beige grey wine red brown grey graphite	<b>Finition</b> > laqué brillant ou laqué mat noir blanc gris poussière gris beige rouge vin gris brun graphite	<b>Ausführung</b> > glänzend lackiert oder matt lackiert Schwarz Weiß Staubgrau Beigegrau Weinrot Braungrau Graphit	<b>Acabado</b> > lacado brillante o lacado opaco negro blanco gris polvo gris beige rojo vino gris parduzco grafito
<b>Optional</b> > ripiani in legno	<b>Optional</b> > wooden shelves	<b>Optionnel</b> > étagères en bois	<b>Optional</b> > Holzregale	<b>Opcional</b> > baldas de madera
> basamenti MCM (H16 cm) MD (H16 / H32 cm)	> metal bases MCM (H16 cm) MD (H16 / H32 cm)	> pieds métalliques MCM (H16 cm) MD (H16 / H32 cm)	> Metallbasis MCM (H16 cm) MD (H16 / H32 cm)	> patas metálicas MCM (H16 cm) MD (H16 / H32 cm)
<b>Nota</b> Di serie ripiani in vetro temperato e piedini H2 cm regolabili.	<b>Notice</b> Tempered glass shelves and adjustable H2 cm feet as standard.	<b>Avertissement</b> Étagères en verre trempé et pieds réglables H2 cm en standard.	<b>Anmerkungen</b> Standard Temperglasregale und regulierbare Standardfüße H2cm.	<b>Aviso</b> Baldas de cristal templado y pies de H2 cm regulables de serie.

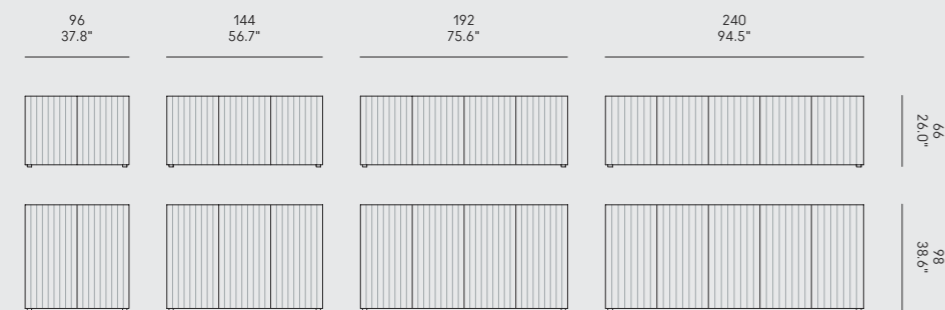

<b>Profondità</b> > 49 cm	<b>Depth</b> > 49 cm / 19.3"	<b>Profondeur</b> > 49 cm	<b>Tiefe</b> > 49 cm	<b>Profundidad</b> > 49 cm
------------------------------	---------------------------------	------------------------------	-------------------------	-------------------------------

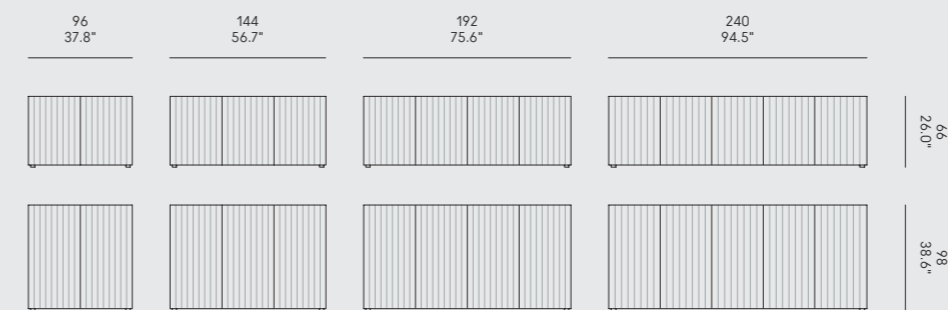

<b>Profondità</b> > 49 cm	<b>Depth</b> > 49 cm / 19.3"	<b>Profondeur</b> > 49 cm	<b>Tiefe</b> > 49 cm	<b>Profundidad</b> > 49 cm
------------------------------	---------------------------------	------------------------------	-------------------------	-------------------------------

Leon Moca

› scocca faggio moca  
› ante ciliegio  
e moca

Leon Mocha

› mocha beech body  
› cherry and  
mocha doors

Leon Moka

› corps hêtre moka  
› portes cerisier  
et moka

Leon Mokka

› Buche Mokka Korpus  
› Kirsche und Mokka  
Türen

Leon Moca

› cuerpo haya moca  
› puertas cerezo  
y moca

Leon Imbiancato

› scocca faggio  
imbiancato  
› ante faggio imbiancato  
e bois blond

Leon Whitened

› whitened beech  
body  
› whitened and bois  
blond beech doors

Leon Bianchi

› corps  
hêtre blanchi  
› portes hêtre blanchi  
et bois blond

Leon Geweißt

› Buche geweißt  
Korpus  
› Buche geweißt und  
Bois Blond Türen

Leon Blanqueado

› cuerpo  
haya blanqueada  
› puertas haya  
blanqueada y bois blond

Leon Bois Blond

› scocca faggio  
bois blond  
› ante faggio bois blond  
e imbiancato

Leon Bois blond

› bois blond beech  
body  
› bois blond and  
whitened beech doors

Leon Bois blond

› corps  
hêtre bois blond  
› portes hêtre bois  
blond et blanchi

Leon Bois Blond

› Buche Bois Blond  
Korpus  
› Buche Bois Blond  
und geweißt Türen

Leon Bois blond

› cuerpo  
haya bois blond  
› puertas haya bois  
blond y blanqueada

Optional

› ripiani in legno

Optional

› wooden shelves

Optionnel

› étagères en bois

Optional

› Holzregale

Opcional

› baldas de madera

basamenti

MCM (H16 cm)  
MD (H16 / H32 cm)

metal bases

MCM (H16 cm)  
MD (H16 / H32 cm)

pieds métalliques

MCM (H16 cm)  
MD (H16 / H32 cm)

Metallbasis

MCM (H16 cm)  
MD (H16 / H32 cm)

patas metálicas

MCM (H16 cm)  
MD (H16 / H32 cm)

Nota

Di serie ripiani in vetro  
temperato e piedini  
H2 cm regolabili.

Notice

Tempered glass shelves  
and adjustable H2 cm  
feet as standard.

Avertissement

Étagères en verre  
trepé et pieds  
réglables H2 cm  
en standard.

Anmerkungen

Standard  
Temperglasregale  
und regulierbare  
Standardfüße H2cm.

Aviso

Baldas de cristal  
templado y pies  
de H2 cm regulables  
de serie.

La misura cm 96 x 66H  
è disponibile solo nella  
versione Leon Moca.

The size cm 96 x 66H  
is only available in the  
Leon Mocha version.

Le format cm 96 x 66H  
n'est disponible que dans  
la version Leon Moka.

Die Größe cm 96 x 66H  
ist nur für die Version  
Leon Mokka erhältlich.

El tamaño cm 96 x 66H  
sólo está disponible en  
versión Leon Moca.

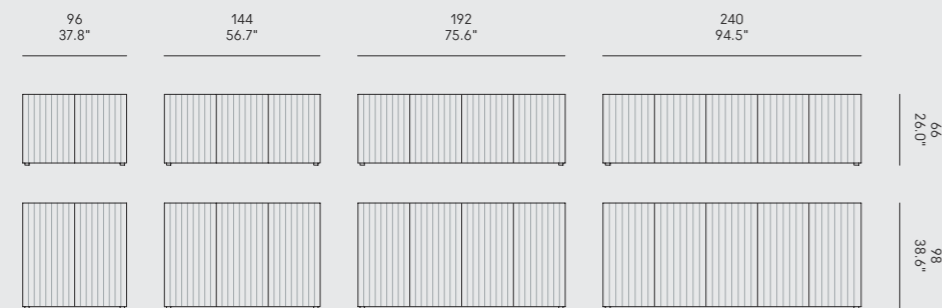
Profondità

› 49 cm

Depth

› 49 cm / 19.3"

Profondeur

› 49 cm

Tiefe

› 49 cm

Profundidad

› 49 cm

Struttura

› metallo verniciato  
nero  
bianco  
bronzo antico

Structure

› painted metal  
black  
white  
bronze antique

Structure

› métal verni  
noir  
blanc  
bronze antique

Struktur

› beschichtetes Metall  
Schwarz  
Weiß  
Vintage Bronze

Estructura

› metal pintado  
negro  
blanco  
bronce antiguo

Ripiani

› ecopelle  
Spradling Valencia  
107-0001 praliné  
107-1049 leinen  
107-4003 grafite  
107-5002 moss  
(vedi pagina 165)

Shelves

› faux leather  
Spradling Valencia  
107-0001 praliné  
107-1049 leinen  
107-4003 grafite  
107-5002 moss  
(see page 165)

Étagères

› similcuir  
Spradling Valencia  
107-0001 praliné  
107-1049 leinen  
107-4003 grafite  
107-5002 moss  
(voir page 165)

Einlegenböden

› Kunstleder  
Spradling Valencia  
107-0001 Praliné  
107-1049 Leinen  
107-4003 Grafite  
107-5002 Moss  
(auf Seite 165)

Estantes

› ecopiel  
Spradling Valencia  
107-0001 praliné  
107-1049 leinen  
107-4003 grafite  
107-5002 moss  
(a página 165)

Nota

Include kit di unione per  
più librerie.

Notice

Includes union kit for  
multiple bookshelves.

Avertissement

Comprend un kit  
d'union pour étagères  
multiples.

Anmerkungen

Inklusive  
Verbindungsset für  
mehrere Bücherregale.

Aviso

Incluye kit de unión  
para múltiples  
estanterías.

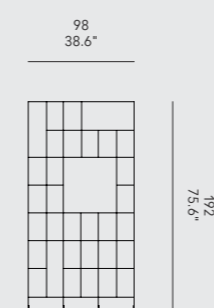
Profondità

› 28 cm

Depth

› 28 cm / 11.0"

Profondeur

› 28 cm

Tiefe

› 28 cm

Profundidad

› 28 cm

Scocca

› laccato lucido  
o laccato opaco  
nero  
bianco  
polvere  
beige  
rosso vino  
bruno  
grafite

Body

› glossy lacquered  
or matt lacquered  
black  
white  
dusty grey  
beige grey  
wine red  
brown grey  
graphite

Corps

› laqué brillant  
ou laqué mat  
noir  
blanc  
gris poussière  
gris beige  
rouge vin  
gris brun  
graphite

Korpus

› glänzend lackiert  
oder matt lackiert  
Schwarz  
Weiß  
Staubgrau  
Beigegräu  
Weinrot  
Braungräu  
Graphit

Cuerpo

› lacado brillante  
o lacado opaco  
negro  
blanco  
gris polvo  
gris beige  
rojo vino  
gris parduzco  
grafito

Ante e fianchi

› legno origami  
in noce canaletto  
brevetto HORM

Doors and sides

› origami wood  
in walnut  
HORM patent

Portes et cotés

› bois origami  
en noyer  
brevet HORM

Türen und Seiten

› Origami-Nussbaum  
HORM-Patent

Puertas y lados

› madera origami  
de nogal  
patente HORM

Optional

› basamenti  
MCM (H16 cm)  
MD (H16 / H32 cm)

Optional

› metal bases  
MCM (H16 cm)  
MD (H16 / H32 cm)

Optionnel

› pieds métalliques  
MCM (H16 cm)  
MD (H16 / H32 cm)

Optional

› Metallbasis  
MCM (H16 cm)  
MD (H16 / H32 cm)

Opcional

› patas metálicas  
MCM (H16 cm)  
MD (H16 / H32 cm)

Nota

Di serie ripiani in vetro  
temperato e piedini  
H2 cm regolabili.

Notice

Tempered glass shelves  
and adjustable H2 cm  
feet as standard.

Avertissement

Étagères en verre  
trempé et pieds  
réglables H2 cm  
en standard.

Anmerkungen

Standard  
Temperglasregale  
und regulierbare  
Standardfüße H2cm.

Aviso

Baldas de cristal  
templado y pies  
de H2 cm regulables  
de serie.

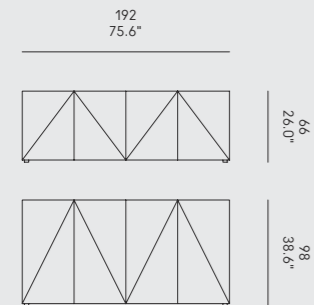
Profondità

› 50 cm

Depth

› 50 cm / 19.7"

Profondeur

› 50 cm

Tiefe

› 50 cm

Profundidad

› 50 cm

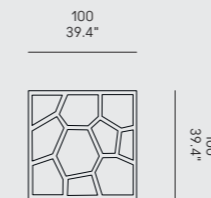
Profondità

› 35 cm

Depth

› 35 cm / 13.8"

Profondeur

› 35 cm

Tiefe

› 35 cm

Profundidad

› 35 cm



Finitura

› laccato lucido  
o laccato opaco  
nero  
bianco  
polvere  
beige  
rosso vino  
bruno  
grafite

Finish

› glossy lacquered  
or matt lacquered  
black  
white  
dusty grey  
beige grey  
wine red  
brown grey  
graphite

Finition

› laqué brillant  
ou laqué mat  
noir  
blanc  
gris poussière  
gris beige  
rouge vin  
gris brun  
graphite

Ausführung

› glänzend lackiert  
oder matt lackiert  
Schwarz  
Weiß  
Staubgrau  
Beigegrü  
Weinrot  
Braungrü  
Graphit

Estructura

› lacado brillante  
o lacado opaco  
negro  
blanco  
gris polvo  
gris beige  
rojo vino  
gris parduzco  
grafito

Optional

› basamenti  
MCM (H16 cm)  
MD (H16 / H32 cm)

Optional

› metal bases  
MCM (H16 cm)  
MD (H16 / H32 cm)

Optionnel

› pieds métalliques  
MCM (H16 cm)  
MD (H16 / H32 cm)

Optional

› Metallbasis  
MCM (H16 cm)  
MD (H16 / H32 cm)

Opcional

› patas metálicas  
MCM (H16 cm)  
MD (H16 / H32 cm)

Nota

Di serie ripiani in vetro temperato e piedini H2 cm regolabili. Illuminazione interna a LED.

Notice

Tempered glass shelves and adjustable H2 cm feet as standard. Indoor LED lighting.

Avertissement

Étagères en verre trempé et pieds réglables H2 cm en standard. Éclairage intérieur à LED.

Anmerkungen

Standard Temperglasregale und regulierbare Standardfüße H2cm. Innere LED-Beleuchtung.

Aviso

Baldas de cristal templado y pies de H2 cm regulables de serie. Iluminación LED para interiores.

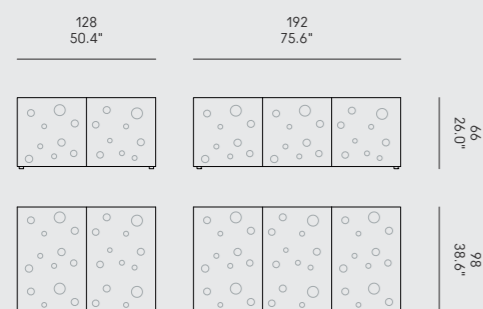
Profondità

› 49 cm

Depth

› 49 cm / 19.3"

Profondeur

› 49 cm

Tiefe

› 49 cm

Profundidad

› 49 cm

Ripiani

› frassino moca  
  
› vetro extraclear

Shelves

› mocha ash  
  
› extraclear glass

Étagères

› frêne moka  
  
› verre extra-clair

Einlegenböden

› Esche Mokka  
  
› extraklares Glas

Estantes

› fresno moca  
  
› vidrio extraclaro

Montanti

› metallo crudo

Uprights

› hard metal

Montants

› métal cru

Pfosten

› Rohmetall

Montantes

› metal crudo

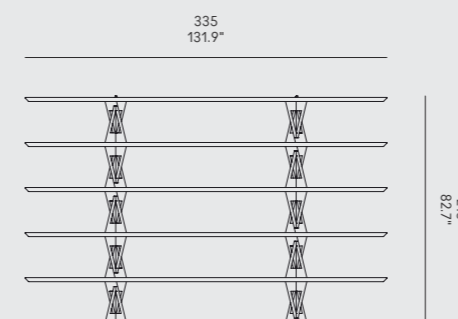
Profondità

› 40 cm

Depth

› 40 cm / 15.7"

Profondeur

› 49 cm

Tiefe

› 49 cm

Profundidad

› 49 cm

Scocca

› laccato lucido  
o laccato opaco  
nero  
bianco  
polvere  
beige  
rosso vino  
bruno  
grafite

Body

› glossy lacquered  
or matt lacquered  
black  
white  
dusty grey  
beige grey  
wine red  
brown grey  
graphite

Corps

› laqué brillant  
ou laqué mat  
noir  
blanc  
gris poussière  
gris beige  
rouge vin  
gris brun  
graphite

Korpus

› glänzend lackiert  
oder matt lackiert  
Schwarz  
Weiß  
Staubgrau  
Beigegräu  
Weinrot  
Braungrau  
Graphit

Cuerpo

› lacado brillante  
o lacado opaco  
negro  
blanco  
gris polvo  
gris beige  
rojo vino  
gris parduzco  
grafito

Ante e fianchi

› legno origami  
in noce canaletto  
brevetto HORM

Doors and sides

› origami wood  
in walnut  
HORM patent

Portes et cotés

› bois origami  
en noyer  
brevet HORM

Türen und Seiten

› Origami-Nussbaum  
HORM-Patent

Puertas y lados

› madera origami  
de nogal  
patente HORM

Optional

› basamenti  
MCM (H16 cm)  
MD (H16 / H32 cm)

Optional

› metal bases  
MCM (H16 cm)  
MD (H16 / H32 cm)

Optionnel

› pieds métalliques  
MCM (H16 cm)  
MD (H16 / H32 cm)

Optional

› Metallbasis  
MCM (H16 cm)  
MD (H16 / H32 cm)

Opcional

› patas metálicas  
MCM (H16 cm)  
MD (H16 / H32 cm)

Nota

Di serie ripiani in vetro temperato e piedini H2 cm regolabili. Illuminazione interna a LED.

Notice

Tempered glass shelves and adjustable H2 cm feet as standard. Indoor LED lighting.

Avertissement

Étagères en verre trempé et pieds réglables H2 cm en standard. Éclairage intérieur à LED.

Anmerkungen

Standard  
Temperglasregale und regulierbare Standardfüße H2cm. Innere LED-Beleuchtung.

Aviso

Baldas de cristal templado y pies de H2 cm regulables de serie. Iluminación LED para interiores.

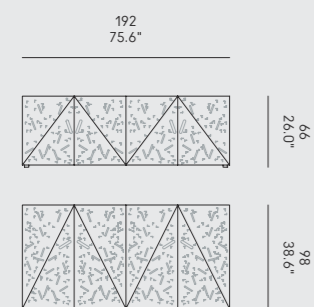
Profondità

› 50 cm

Depth

› 50 cm / 19.7"

Profondeur

› 50 cm

Tiefe

› 50 cm

Profundidad

› 50 cm

Robox

Metallo bianco  
› corpo bianco  
› cuore rosso

Robox

White metal  
› white body  
› red heart

Robox

Métal blanc  
› corps blanc  
› cœur rouge

Robox

weißes Metall  
› weißer Körper  
› rotes Herz

Robox

Metall blanco  
› cuerpo blanco  
› corazón rojo

Robox

Metallo grigio  
› corpo grigio  
› cuore rosso

Robox

Grey metal  
› grey body  
› red heart

Robox

Métal gris  
› corps gris  
› cœur rouge

Robox

graues Metall  
› grauer Körper  
› rotes Herz

Robox

Metall gris  
› cuerpo gris  
› corazón rojo

Robox

Metallo multicolor  
› corpo bianco,  
blu e giallo  
› cuore rosso

Robox

Multicolor metal  
› white blue  
and yellow body  
› red heart

Robox

Métal multicolor  
› corps blanc,  
bleu et jaune  
› cœur rouge

Robox

Multicolor Metall  
› weißer, blauer  
und gelber Körper  
› rotes Herz

Robox

Metall multicolor  
› cuerpo blanco,  
azul y amarillo  
› corazón rojo

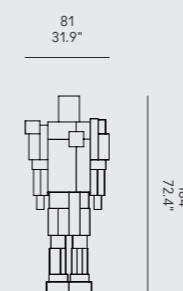
Profondità

› 30 cm

Depth

› 30 cm / 11.8"

Profondeur

› 30 cm

Tiefe

› 30 cm

Profundidad

› 30 cm



Torniti

› legno massello  
noce e ontano

Uprights

› solid wood  
walnut and alder

Montants

› bois massif  
noyer et aulne

Gedrehte Stäbe

› Massivholz  
Nussbaum und Erle

Montantes

› madera maciza  
nogal y aliso

Ripiani

› MDF impiallacciato  
con alluminio finitura  
specchio

Shelves

› MDF veneered with  
aluminium mirror finish

Étagères

› MDF plaqué  
aluminium brillant

Einlegenböden

› MDF Platte mit  
Aluminium-Spiegelung

Estantes

› MDF enchapado con  
acabado de aluminio  
espejo

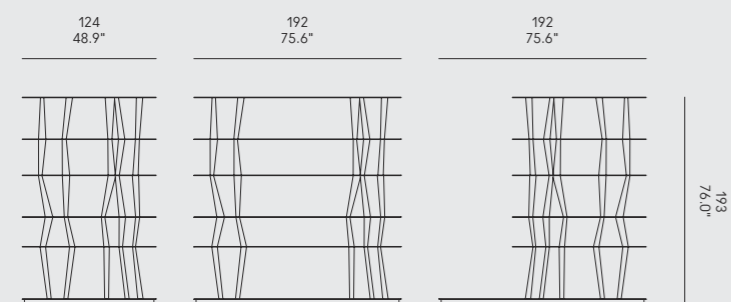

Profondità  
› 48 cm

Depth  
› 48 cm / 18.9"

Profondeur  
› 48 cm

Tiefe  
› 48 cm

Profundidad  
› 48 cm

Torniti

› legno massello  
noce e ontano

Uprights

› solid wood  
walnut and alder

Montants

› bois massif  
noyer et aulne

Gedrehte Stäbe

› Massivholz  
Nussbaum und Erle

Montantes

› madera maciza  
nogal y aliso

Ripiani

› vetro  
trasparente  
fumè  
bronzato

Shelves

› glass  
crytal clear  
smoked  
bronzed

Étagères

› verre  
transparent  
fumé  
bronzé

Einlegenböden

› Glas  
transparent  
rauchfarbig  
bronziert

Estantes

› vidrio  
transparente  
ahumado  
bronceado

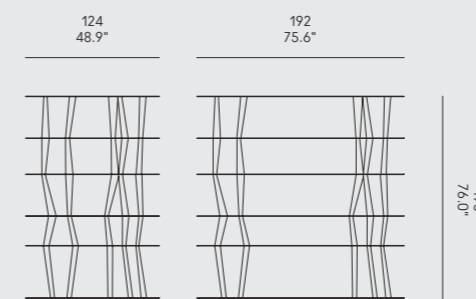
Ripiani

› trasparente

Shelves

› clear

Étagères

› transparent

Einlegenböden

› transparent

Estantes

› transparente

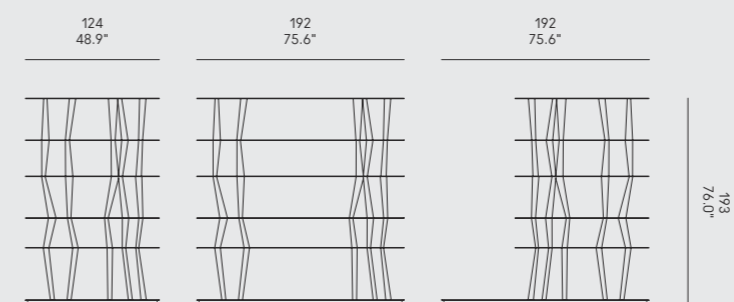
Ripiani

› fumè  
› bronzato

Shelves

› smoky  
› bronzed

Étagères

› fumé  
› bronzé

Einlegenböden

› rauchfarbig  
› bronziert

Estantes

› ahumado  
› bronceado

Profondità  
› 48 cm

Depth  
› 48 cm / 18.9"

Profondeur  
› 48 cm

Tiefe  
› 48 cm

Profundidad  
› 48 cm

Finitura

- > laccato opaco nero
- bianco
- polvere
- beige
- rosso vino
- bruno
- grafite

Finish

- > matt lacquered black
- white
- dusty grey
- beige grey
- wine red
- brown grey
- graphite

Finition

- > laqué mat noir
- blanc
- gris poussière
- gris beige
- rouge vin
- gris brun
- graphite

Ausführung

- > matt lackiert Schwarz
- Weiß
- Staubgrau
- Beigegräu
- Weinrot
- Braungräu
- Graphit

Acabado

- > lacado opaco negro
- blanco
- gris polvo
- gris beige
- rojo vino
- gris parduzco
- grafito

Montanti

- > laccato opaco bianco
- > noce canaletto

Uprights

- > white matt lacquered
- > walnut

Montants

- > laqué mat blanc
- > noyer

Pfosten

- > weiß matt lackiert
- > Nussbaum

Montantes

- > lacado opaco blanco
- > nogal

Ripiani

- > laccato opaco bianco

Shelves

- > white matt lacquered

Étagères

- > laqué mat blanc

Einlegenböden

- > weiß matt lackiert

Estantes

- > lacado opaco blanco

Nota

In fase di montaggio, le due colonnine possono essere accostati a 60, 90 o 120 gradi tra loro.

Notice

During assembly, the two columns can be combined at 60, 90 or 120 degrees between them.

Avertissement

Lors du montage, les deux colonnes peuvent être combinées à 60, 90 ou 120 degrés entre elles.

Anmerkungen

Bei der Montage können die beiden Säulen in einem Abstand von 60, 90 oder 120 Grad kombiniert werden.

Aviso

Durante el montaje, las dos columnas pueden combinarse a 60, 90 o 120 grados entre ellas.

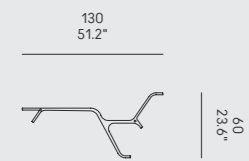

Profondità

- > 21 cm

Depth

- > 21 cm / 8.3"

Profondeur

- > 21 cm

Tiefe

- > 21 cm

Profundidad

- > 21 cm

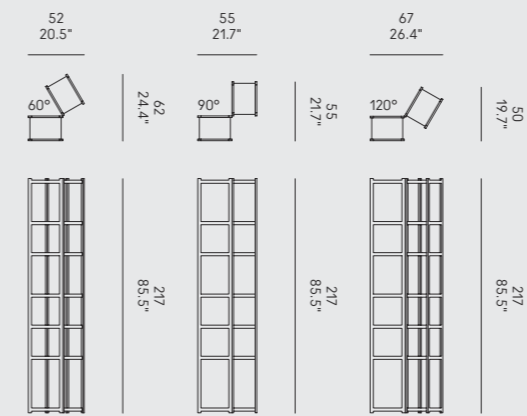

Dimensione ripiano

- > 20 x 32 cm

Shelf size

- > 20 x 32 cm / 7.9" x 12.6"

Mesure d'étagère

- > 20 x 32 cm

Einlegenböden Größe

- > 20 x 32 cm

Tamaño del estante

- > 20 x 32 cm

Pannelli

> laccato lucido  
o laccato opaco  
nero  
bianco  
polvere  
beige  
rosso vino  
bruno  
grafite

Panels

> glossy lacquered  
or matt lacquered  
black  
white  
dusty grey  
beige grey  
wine red  
brown grey  
graphite

Panneaux

> laqué brillant  
ou laqué mat  
noir  
blanc  
gris poussière  
gris beige  
rouge vin  
gris brun  
graphite

Panels

> glänzend lackiert  
oder matt lackiert  
Schwarz  
Weiß  
Staubgrau  
Beigegrau  
Weinrot  
Braungrau  
Graphit

Paneles

> lacado brillante  
o lacado opaco  
negro  
blanco  
gris polvo  
gris beige  
rojo vino  
gris parduzco  
grafito

Telaio e  
ripiano interno

> rovere naturale  
> rovere mocha

Frame and  
internal shelf

> natural oak  
> mocha oak

Cadre et étagère  
intérieure

> chêne naturel  
> chêne moka

Rahmen  
und Innenregal

> Eiche Natur  
> Eiche Mokka

Marco y  
balda interior

> roble natural  
> roble mocha

Nota

Nella configurazione standard il vano esterno dell'armadio è sempre a destra. Su richiesta può essere posizionato a sinistra.

Notice

In the standard configuration, the outer cabinet compartment is always on the right. On request, it can be positioned on the left.

Avertissement

Dans la configuration standard, le compartiment extérieur de l'armoire est toujours à droite. Sur demande, il peut être positionné à gauche.

Anmerkungen

In der Standard Konfiguration befindet sich das äußere Schrankfach immer rechts. Auf Anfrage kann auf der linken Seite platziert werden.

Aviso

En la configuración estándar, el compartimento exterior del armario está siempre a la derecha. A petición se puede posicionar a la izquierda.



Profondità  
> 58 cm

Depth  
> 58 cm / 22.8"

Profondeur  
> 58 cm

Tiefe  
> 58 cm

Profundidad  
> 58 cm

Ripiani, schienali  
e contenitori

> laccato lucido  
o laccato opaco  
nero  
bianco  
polvere  
beige  
rosso vino  
bruno  
grafite

Shelves, back panels  
and boxes

> glossy lacquered  
or matt lacquered  
black  
white  
dusty grey  
beige grey  
wine red  
brown grey  
graphite

Etagères, dossiers  
et meubles  
de rangement

> laqué brillant  
ou laqué mat  
noir  
blanc  
gris poussière  
gris beige  
rouge vin  
gris brun  
graphite

Regale, Rücklehnen  
und Behälter

> glänzend lackiert  
oder matt lackiert  
Schwarz  
Weiß  
Staubgrau  
Beigegrau  
Weinrot  
Braungrau  
Graphit

Estantes, respaldos  
y contenedores

> lacado brillante  
o lacado opaco  
negro  
blanco  
gris polvo  
gris beige  
rojo vino  
gris parduzco  
grafito

Montanti

> rovere naturale  
> rovere mocha

Uprights

> natural oak  
> mocha oak

Montants

> chêne naturel  
> chêne moka

Pfosten

> Eiche Natur  
> Eiche Mokka

Estantes

> roble natural  
> roble mocha

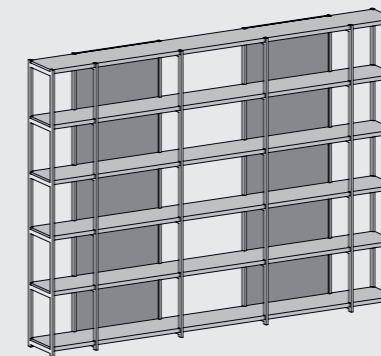
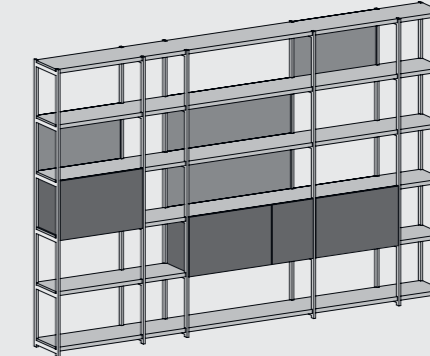
Esempidi composizioneExamplesof compositionExemplesde compositionBeispielevon KompositionEjemplosde composiciónProfondità

> 32 cm

Depth

> 32 cm / 12.6"

Profondeur

> 32 cm

Tiefe

> 32 cm

Profundidad

> 32 cm

Altezza

> 198 cm

Height

> 198 cm / 78.0"

Hauteur

> 198 cm

Hohe

> 198 cm

Altura

> 198 cm

Modularità

La libreria può avere infinite combinazioni considerando i seguenti moduli:

> 16 cm  
> 32 cm  
> 64 cm  
> 80 cm  
> 96 cm

Modularity

The library can have endless combinations considering the following modules:

16 cm / 6.3"  
32 cm / 12.6"  
64 cm / 25.2"  
80 cm / 31.5"  
96 cm / 37.8"

Modularité

La bibliothèque peut avoir multiple combinaisons en utilisant les modules suivants:

> 16 cm  
> 32 cm  
> 64 cm  
> 80 cm  
> 96 cm

Modulbauweise

Das Bücherregal kann viele Kombinationen haben, wenn man die folgenden Module betrachtet:

> 16 cm  
> 32 cm  
> 64 cm  
> 80 cm  
> 96 cm

Modularidad

La biblioteca puede tener múltiples combinaciones utilizando los siguientes módulos:

> 16 cm  
> 32 cm  
> 64 cm  
> 80 cm  
> 96 cm

Per maggiori informazioni vedere listino

For more info, please see price list

Pour plus d'informations, voir la liste des prix.

Weitere Infos in der Preisliste

Para más información, consulte la tarifa.

Scocca

› laccato lucido  
o laccato opaco  
nero  
bianco  
polvere  
beige  
rosso vino  
bruno  
grafite

Body

› glossy lacquered  
or matt lacquered  
black  
white  
dusty grey  
beige grey  
wine red  
brown grey  
graphite

Corps

› laqué brillant  
ou laqué mat  
noir  
blanc  
gris poussière  
gris beige  
rouge vin  
gris brun  
graphite

Korpus

› glänzend lackiert  
oder matt lackiert  
Schwarz  
Weiß  
Staubgrau  
Beigegrü  
Weinrot  
Braungrü  
Graphit

Cuerpo

› lacado brillante  
o lacado opaco  
negro  
blanco  
gris polvo  
gris beige  
rojo vino  
gris parduzco  
grafito

› faggio moca  
› faggio imbiancato  
› faggio bois blond

› mocha beech  
› whitened beech  
› bois blond beech

› hêtre moka  
› hêtre blanchi  
› hêtre bois blond

› Buche Mokka  
› Buche geweißt  
› Buche Bois Blond

› haya moca  
› haya blanqueada  
› haya bois blond

Ante

› laccato lucido  
o laccato opaco  
nero  
bianco  
polvere  
beige  
rosso vino  
bruno  
grafite

Doors

› glossy lacquered  
or matt lacquered  
black  
white  
dusty grey  
beige grey  
wine red  
brown grey  
graphite

Portes

› laqué brillant  
ou laqué mat  
noir  
blanc  
gris poussière  
gris beige  
rouge vin  
gris brun  
graphite

Türen

› glänzend lackiert  
oder matt lackiert  
Schwarz  
Weiß  
Staubgrü  
Beigegrü  
Weinrot  
Braungrü  
Graphit

Puertas

› lacado brillante  
o lacado opaco  
negro  
blanco  
gris polvo  
gris beige  
rojo vino  
gris parduzco  
grafito

Basamento obbligatorio

› MCM (H16 cm)  
› MD (H16 / H32 cm)

Compulsory base

› MCM (H16 cm)  
› MD (H16 / H32 cm)

Pieds obligatoires

› MCM (H16 cm)  
› MD (H16 / H32 cm)

Obligatorische Basis

› MCM (H16 cm)  
› MD (H16 / H32 cm)

Patas obligatorias

› MCM (H16 cm)  
› MD (H16 / H32 cm)

Optional

› ripiani in legno

Optional

› wooden shelves

Optionnel

› étagères en bois

Optional

› Holzregale

Opcional

› baldas de madera

Nota

Di serie ripiani in vetro temperato.

Notice

Tempered glass shelves as standard.

Avertissement

Étagères en verre trempé en standard.

Anmerkungen

Standard  
Temperglasregale.

Aviso

Baldas de vidrio templado de serie.

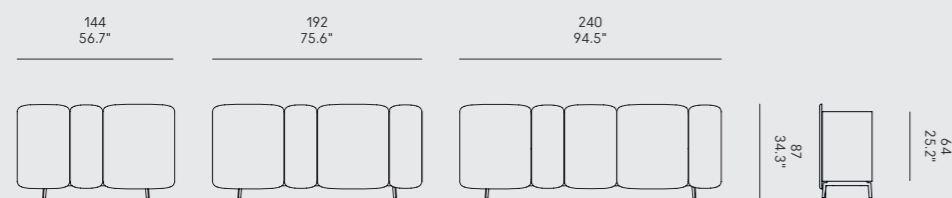
Profondità

› 49 cm

Depth

› 49 cm / 19.3"

Profondeur

› 49 cm

Tiefe

› 49 cm

Profundidad

› 49 cm

Finitura

› legno nero-bianco  
e alluminio finitura  
specchio

Finish

› black-white wood and  
aluminium mirror finish

Finition

› bois noir-blanc et  
aluminium brillant

Ausführung

› Schwarz-weiß Holz  
und Aluminium-  
Spiegelung

Acabado

› madera negro-blanco  
y acabado  
de aluminio espejo

Note

Con più moduli singoli è possibile creare un sistema parete continuo. Il fianco della libreria, di mezza profondità rispetto alle mensole, permette di accostare più moduli senza raddoppiare lo spessore dei fianchi.

Notice

By adding single modules, it is possible to create a continuous wall system. The sides, which are half the depth of the shelves, make it possible to put several modules side by side without doubling the width of the sides.

Avertissement

Avec plusieurs modules simples, il est possible de créer un système de paroi continue. Le côté, d'une profondeur moyenne par rapport aux étagères, permet de placer plusieurs modules sans doubler l'épaisseur des côtés.

Anmerkungen

Mit mehreren Einzelmodulen kann ein durchlaufendes Wandsystem zusammengestellt werden. Die Seite von halber Tiefe im Vergleich zum Regal ermöglicht das Aneinanderstellen mehrerer Module, ohne die Stärke der Seiten zu verdoppeln.

Aviso

Con varios módulos individuales se puede crear un sistema mural continuo. El lado, de media profundidad con respecto a las repisas, permite colocar juntos más módulos sin duplicar el espesor de los lados.

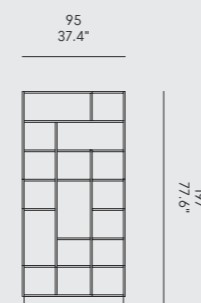
Profondità

› 26 cm

Depth

› 26 cm / 10.2"

Profondeur

› 26 cm

Tiefe

› 26 cm

Profundidad

› 26 cm

<u>Finitura</u> > laccato lucido o laccato opaco nero bianco polvere beige rosso vino bruno grafite	<u>Finish</u> > glossy lacquered or matt lacquered black white dusty grey beige grey wine red brown grey graphite	<u>Finition</u> > laqué brillant ou laqué mat noir blanc gris poussière gris beige rouge vin gris brun graphite	<u>Ausführung</u> > glänzend lackiert oder matt lackiert Schwarz Weiß Staubgrau Beigegrau Weinrot Braungrau Graphit	<u>Acabado</u> > lacado brillante o lacado opaco negro blanco gris polvo gris beige rojo vino gris parduzco grafito
<u>Fianco cassette</u> > alluminio	<u>Drawer sides</u> > aluminium	<u>Côté des tiroirs</u> > aluminium	<u>Schubladenseite</u> > Aluminium	<u>Laterales de cajones</u> > aluminio
<u>Basamento obbligatorio</u> > MCM (H16 cm) > MD (H16 / H32 cm)	<u>Compulsory base</u> > MCM (H16 cm) > MD (H16 / H32 cm)	<u>Pieds obligatoires</u> > MCM (H16 cm) > MD (H16 / H32 cm)	<u>Obligatorische Basis</u> > MCM (H16 cm) > MD (H16 / H32 cm)	<u>Patas obligatorias</u> > MCM (H16 cm) > MD (H16 / H32 cm)

<u>Finitura</u> > laccato lucido o laccato opaco nero bianco polvere beige rosso vino bruno grafite	<u>Finish</u> > glossy lacquered or matt lacquered black white dusty grey beige grey wine red brown grey graphite	<u>Finition</u> > laqué brillant ou laqué mat noir blanc gris poussière gris beige rouge vin gris brun graphite	<u>Ausführung</u> > glänzend lackiert oder matt lackiert Schwarz Weiß Staubgrau Beigegrau Weinrot Braungrau Graphit	<u>Acabado</u> > lacado brillante o lacado opaco negro blanco gris polvo gris beige rojo vino gris parduzco grafito
<u>Fianco cassette</u> > alluminio	<u>Drawer sides</u> > aluminium	<u>Côté des tiroirs</u> > aluminium	<u>Schubladenseite</u> > Aluminium	<u>Laterales de cajones</u> > aluminio
<u>Optional</u> > basamenti MCM (H16 cm) MD (H16 / H32 cm)	<u>Optional</u> > metal bases MCM (H16 cm) MD (H16 / H32 cm)	<u>Optionnel</u> > pieds métalliques MCM (H16 cm) MD (H16 / H32 cm)	<u>Optional</u> > Metallbasis MCM (H16 cm) MD (H16 / H32 cm)	<u>Opcional</u> > patas metálicas MCM (H16 cm) MD (H16 / H32 cm)
<u>Nota</u> Di serie piedini H2 cm regolabili.	<u>Notice</u> Adjustable H2 cm feet as standard.	<u>Avertissement</u> Pieds réglables H2 cm en standard.	<u>Anmerkungen</u> Regulierbare Standardfüße H2cm.	<u>Aviso</u> Pies regulables de H2 cm de serie.

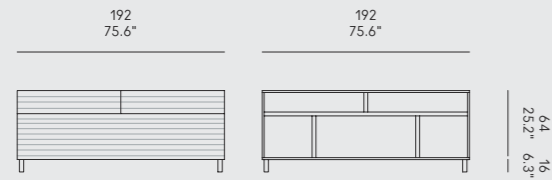

<u>Profondità</u> > 60 cm	<u>Depth</u> > 60 cm / 23.6"	<u>Profondeur</u> > 60 cm	<u>Tiefe</u> > 60 cm	<u>Profundidad</u> > 60 cm
------------------------------	---------------------------------	------------------------------	-------------------------	-------------------------------

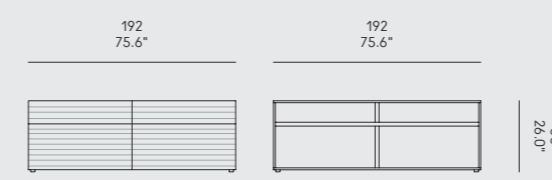

<u>Profondità</u> > 60 cm	<u>Depth</u> > 60 cm / 23.6"	<u>Profondeur</u> > 60 cm	<u>Tiefe</u> > 60 cm	<u>Profundidad</u> > 60 cm
------------------------------	---------------------------------	------------------------------	-------------------------	-------------------------------

<b>Finitura</b> › polietilene nero bianco polvere beige	<b>Finish</b> › polyethylene black white dusty grey beige grey	<b>Finition</b> › polyéthylène noir blanc gris poussière gris beige	<b>Ausführung</b> › Polyethylen Schwarz Weiß Staubgrau Beigegrau	<b>Acabado</b> › polietileno negro blanco gris polvo gris beige
--	---	--	---	--

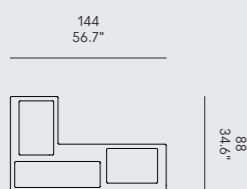

<b>Profondità</b> › 35 cm	<b>Depth</b> › 35 cm / 13.8"	<b>Profondeur</b> › 35 cm	<b>Tiefe</b> › 35 cm	<b>Profundidad</b> › 35 cm
------------------------------	---------------------------------	------------------------------	-------------------------	-------------------------------

## Valises

<b>Finitura</b> › cuoietto sfumature di blu sfumature di verde sfumature di beige multicolor	<b>Finish</b> › hard leather grade 2 nuances of blue nuances of green nuances of beige multicolor	<b>Finition</b> › cuir nuances de bleu nuances de vert nuances de beige multicolor	<b>Ausführung</b> › Kernleder Blautöne Grüntöne Beigetöne Multicolor	<b>Acabado</b> › cuero tonos de azul tonos de verde tonos de beige multicolor
---	--	---	---	--

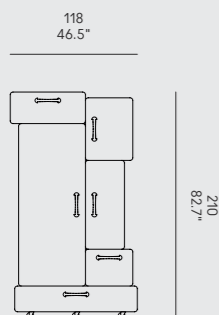

<b>Profondità</b> › 70 cm	<b>Depth</b> › 70 cm / 27.6"	<b>Profondeur</b> › 70 cm	<b>Tiefe</b> › 70 cm	<b>Profundidad</b> › 70 cm
------------------------------	---------------------------------	------------------------------	-------------------------	-------------------------------

## Web Stopper

<b>Finitura</b> › alluminio verniciato nero bianco polvere beige	<b>Finish</b> › painted aluminium black white dusty grey beige grey	<b>Finition</b> › aluminium verni noir blanc gris poussière gris beige	<b>Ausführung</b> › beschichtetes Aluminium Schwarz Weiß Staubgrau Beigegrau	<b>Acabado</b> › aluminio pintado negro blanco gris polvo gris beige
---	--	---	---	---

<b>Fermalibri</b> › metallo zincato	<b>Bookends</b> › galvanized metal	<b>Serre-livres</b> › métal galvanisé	<b>Buchstopper</b> › verzinktes Metall	<b>Sujetalibros</b> › metal galvanizado
--	---------------------------------------	--	---	--

<b>Nota</b> Su richiesta le mensole possono essere accorciate su misura	<b>Notice</b> On request the shelves can be shortened to measure.	<b>Avertissement</b> Sur demande, les étagères peuvent être raccourcies sur mesure.	<b>Anmerkungen</b> Auf Wunsch können die Regale nach Maß gekürzt werden.	<b>Aviso</b> A petición, los estantes se pueden acortar a medida.
--	--	--	---	--

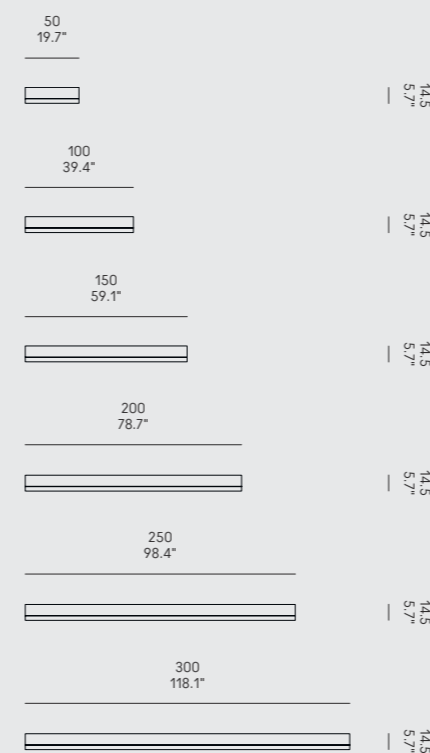

<b>Profondità</b> › 23 cm	<b>Depth</b> › 23 cm / 9.1"	<b>Profondeur</b> › 23 cm	<b>Tiefe</b> › 23 cm	<b>Profundidad</b> › 23 cm
------------------------------	--------------------------------	------------------------------	-------------------------	-------------------------------

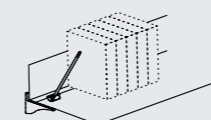

<b>Fermalibri</b>	<b>Bookends</b>	<b>Serre-livres</b>	<b>Buchstopper</b>	<b>Sujetalibros</b>
-------------------	-----------------	---------------------	--------------------	---------------------

<u>Montanti</u> > alluminio spazzolato bianco	<u>Uprights</u> > aluminium brushed white	<u>Montants</u> > aluminium brossé blanc	<u>Pfosten</u> > Aluminium gebürstet Weiß	<u>Montantes</u> > aluminio cepillado blanco
<u>Piedini e supporti</u> > plastica grigio bianco	<u>Feet and supports</u> > plastic grey white	<u>Pieds et supports</u> > plastique gris blanc	<u>Füße und Stützen</u> > Kunststoff Grau Weiß	<u>Pies y soportes</u> > plástico gris blanco
<u>Ripiani</u> > melaminico bianco  > metallo grigio bianco	<u>Shelves</u> > melamine white  > metal grey white	<u>Étagères</u> > mélamine blanc  > métal gris blanc	<u>Einlegenböden</u> > Melamin Weiß  > Metall Grau Weiß	<u>Estantes</u> > melamina blanco  > metal gris blanco
<u>Contenitori</u> > melaminico bianco	<u>Cabinets</u> > melamine white	<u>Muebles de rangement</u> > mélamine blanc	<u>Behälter</u> > Melamin Weiß	<u>Contenedores</u> > melamina blanco
<u>Nota</u> La scaffalatura offre due tipi di montaggio: > pavimento-soffitto > pavimento-parete	<u>Notice</u> The rack offers two types of assembly: > floor-to-ceiling > floor-to-wall	<u>Avertissement</u> Le rack offre deux types de montage: > plafon-plancher > mur-plancher	<u>Anmerkungen</u> Das Gestell bietet zwei Montagearten: > Boden-Decke > Boden-Wand	<u>Aviso</u> La estantería ofrece dos tipos de montaje: > suelo-techo > suelo-pared

<u>Esempi di composizione</u>	<u>Examples of composition</u>	<u>Exemples de composition</u>	<u>Beispiele von Komposition</u>	<u>Ejemplos de composición</u>
-------------------------------	--------------------------------	--------------------------------	----------------------------------	--------------------------------

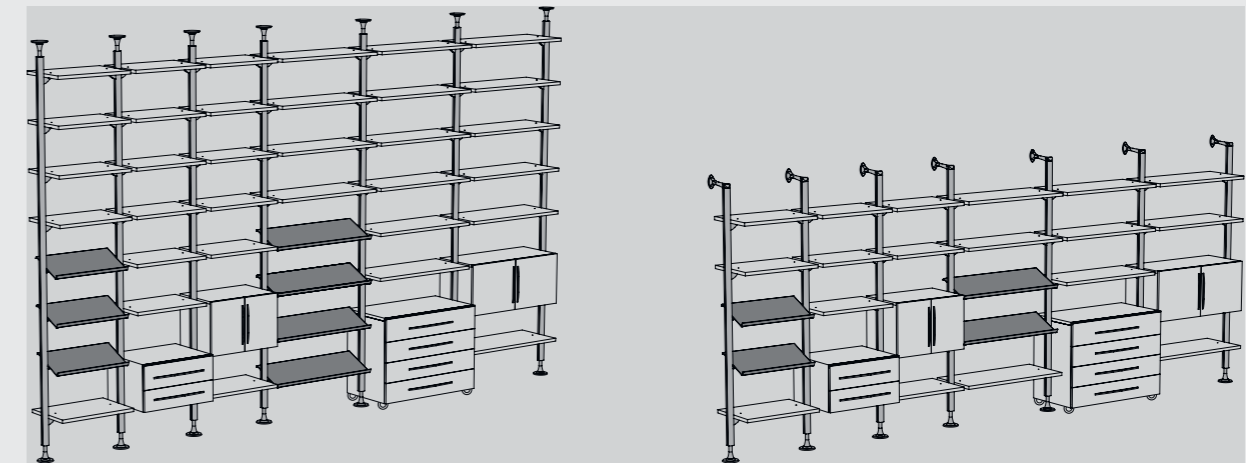

<u>Profondità ripiani</u> > 30 cm > 42 cm	<u>Shelves depth</u> > 30 cm > 42 cm	<u>Profondeur des étagères</u> > 30 cm > 42 cm	<u>Einlegenböden Tiefe</u> > 30 cm > 42 cm	<u>Profundidad estantes</u> > 30 cm > 42 cm
<u>Profondità contenitori</u> > 50 cm	<u>Storage units depth</u> > 50 cm	<u>Profondeur des meubles de rangement</u> > 50 cm	<u>Behälter Tiefe</u> > 50 cm	<u>Profundidad contenedores</u> > 50 cm
<u>Altezza</u> > fino a 400 cm	<u>Height</u> > up to 400 cm	<u>Hauteur</u> > jusqu'à 400 cm	<u>Hohe</u> > bis zu 400 cm	<u>Altura</u> > hasta 400 cm
<u>Modularità</u> La libreria può avere infinite combinazioni considerando i seguenti moduli: > 62 cm > 92 cm	<u>Modularity</u> The library can have endless combinations considering the following modules: > 62 cm > 92 cm	<u>Modularité</u> La bibliothèque peut avoir multiple combinaisons en utilisant les modules suivants: > 62 cm > 92 cm	<u>Modulbauweise</u> Das Bücherregal kann viele Kombinationen haben, wenn man die folgenden Module betrachtet: > 62 cm > 92 cm	<u>Modularidad</u> La biblioteca puede tener múltiples combinaciones utilizando los siguientes módulos: > 62 cm > 92 cm
Per maggiori informazioni vedere listino.	For more info, please see price list.	Pour plus d'informations, voir la liste des prix.	Weitere Infos in der Preisliste.	Para más información, consulte la tarifa.

Art Director

Renato Zamberlan

PhotosGianni Antoniali  
/ Ikon ProductionsSet DresserClaudia Sani  
/ Ikon Productionsexcept:Casamania image bank  
78, 79, 82, 92, 94, 95,  
102, 103, 104, 1045,  
106, 107, 134, 135,  
136, 137, 138, 139,  
140, 141, 142, 143,  
144, 145, 146, 147,  
148, 149, 150, 151Thanks to:Bosa Ceramiche  
Cc-tapis  
London ArtHorm, Casamania and Orizzonti Italia  
are registered trademarks of:Horm Italia Srlvia Antonio Carpenè, 17  
33070 Brugnera (PN)  
ItalyInternational  
Sales Desk  
orders@horm.it  
Tel. +39 0434 1979101Ufficio Commerciale  
Italia  
ordini@horm.it  
Tel. +39 0434 1979102horm.it  
casamania.it  
orizzontiitalia.it#HormDesign  
#Casamania  
#HormCasamania

© Horm Italia Srl

Tutti i prodotti illustrati  
in questo catalogo sono  
Made in ItalyAll products illustrated  
in this catalogue are  
Made in ItalyTous les produits  
illustrés dans  
ce catalogue sont  
Made in ItalyAlle produkte in  
diesem katalog sind  
Made in ItalyTodos los productos  
presentados en este  
catálogo son  
Made in Italy

Horm Italia Srl si riserva la facoltà di apportare, in qualunque momento e senza preavviso, modifiche e/o migliorie di carattere tecnico o estetico ai prodotti illustrati nel presente catalogo e declina ogni responsabilità per eventuali inesattezze contenute nello stesso. Le textures ed i colori dei materiali e delle finiture hanno valore indicativo in quanto soggetti alle tolleranze dei processi di stampa.

Horm Italia Srl reserves the right to make, at any time and without notice, technical or aesthetic changes and/or improvements to the products illustrated in this catalogue and declines all responsibility for any inaccuracies contained in it. Textures and colours of materials and finishes are indicative as they are subject to the tolerances of printing processes.

Horm Italia Srl se réserve le droit d'apporter, à tout moment et sans notification préalable, des modifications et/ou des améliorations de type technique ou esthétique aux produits illustrés dans le présent catalogue, et décline toute responsabilité pour les éventuelles inexactitudes contenues dans ce catalogue. Les textures et les couleurs des matériaux et des finitions sont une valeur indicative parce-que ils changent selon la tolérance aux procédés d'imprimerie.

Horm Italia Srl behält sich das Recht vor, jederzeit und ohne vorherige, Ankündigung Änderungen und/oder technische oder ästhetische Verbesserungen an den im vorliegenden Katalog dargestellten Produkten vorzunehmen, und übernimmt keine Verantwortung für eventuelle darin enthaltene Ungenauigkeiten. Die Texturen und Farben der Materialien und Finish haben einen indicativen Wert, da sie von den Toleranzen im Druckprozess abhängig sind.

Horm Italia Srl se reserva la facultad de aportar, en cualquier momento y sin previo aviso, cambios y mejoras de carácter técnico o estético a los productos ilustrados en este catálogo, y se exime de toda responsabilidad por cualesquiera inexactitudes que éste catálogo pueda contener. Las textures y los colores de los materiales y de los acabados tienen solo un valor indicativo porque están sujetos a la tolerancia de los procesos de imprenta.



