



**contemporary collection**

LIVING THE SPACE



**contemporary collection**

LIVING THE SPACE



# 1984/2019

BALERI ITALIA - 35 ANNI DI DESIGN

Baleri Italia è il marchio icona del XX secolo, fondato da Enrico Baleri e Marilisa Decimo nel 1984, gli anni della sobrietà e del rigore forma/funzione, la massima espressione di una certa idea di design, pragmatica e insieme utopica, all'inseguimento dell'oggetto autentico, non obsolecente, non appariscente, coerente, internazionale. Oggetti e collezioni evergreen, firmate da grandi maestri ed esordienti divenuti poi riferimenti di stile, hanno dato vita a un universo contemporary classic che oggi ritrova vitalità, produzione, comunicazione e forza commerciale.

Il gallo rosso, marchio di fabbrica Baleri Italia, è simbolo augurale di ottimismo, buon umore, fortuna.

Baleri Italia, founded by Enrico Baleri and Marilisa Decimo in 1984, is an iconic brand of the 20th Century, the years of sobriety and rigor of forms/functions, the ultimate expression of a certain pragmatic and unattainable design idea; in pursuit of the perfect, non-obsolete, non-flashy, consistent and international object. Evergreen objects and collections, signed by great masters and newcomers who then became the references in terms of style, gave life to a classical-contemporary universe that now has found, a new vitality, production, communication and commercial strength.

The Red Rooster, Baleri Italia's trademark, stands for our cheerful and optimistic approach.





## CONTEMPORARY COLLECTION

### LIVING THE SPACE

Gli spazi domestici contemporanei mutano riportando al centro della casa le persone ed accogliendo nuove e più fluide forme dell'abitare, gli arredi si adattano a nuovi stili di vita e trovano spazio negli stessi luoghi la convivialità e il privato.

Baleri Italia raccoglie la sfida della contemporaneità presentando una collezione che si arricchisce di nuovi arredi e complementi che uniscono ricerca estetica, funzionalità e spunti ironici nel segno del rispetto del proprio DNA che da sempre ambisce a proporre un design significativo e oltre le mode.

The contemporary house has changed according to new ways of living and habits, re-focusing around people. Furniture as well is adapting to modern lifestyles and the same spaces house private and social moments and activities.

Baleri Italia plays a role in the present times, introducing a collection of furniture and accessories enriched of new products featuring beauty, functionality and playful details. It aims to follow the path of its DNA values for a timeless, meaningful design.

# INDEX

Roundel	6
First	16
Kin	24
Donna	30
Paloma	42
Madam	50
Milady	54
Tape	58
Kin lounge	64
Chromosome X & Y	68
Miss Match	74
Trays	82
Picos	94
Match Point	100
Guida Illustrata / Illustrated Guide	106

# ROUNDEL

Claesson Koivisto Rune

2018





Donna | Roundel

## Roundel

Claesson Koivisto Rune | 2018

Roundel è un tavolo che celebra la figura del cerchio a più livelli, a partire dalla forma del piano, fino alla suddivisione dello stesso in tre diversi dischi realizzabili in materiali e/o colori diversi che suggeriscono altrettante zone di utilizzo. Dalla forte qualità scultorea, quasi fosse realizzato da un vasaio, Roundel permette di dar vita a configurazioni fortemente democratiche: i tavoli rotondi non presuppongono nessuna gerarchia e permettono il migliore contatto visivo possibile tra tutte le persone sedute attorno.

The Roundel table celebrates circular shapes in a number of ways, including with the form of the top and the three different discs into which it is divided, which can be made with a range of colours and/or materials in order to mark out separate areas of use. With its highly sculptural qualities, Roundel is almost like a piece of pottery and it can be used in extremely democratic arrangements and layouts because round tables present no sense of hierarchy and they facilitate maximum eye contact among all the people sitting around them.



Roundel

piano in cristallo temperato extra chiaro retroverniciato e struttura laccata lucida bianca  
top in extra clear tempered back-varnished glass and soft-polished white lacquered structure



- ↑ Roundel: piano in cristallo temperato extra chiaro retroverniciato, marmo Nero Marquinia e rovere laccato nero - struttura laccata lucida nera | top: extra clear tempered back-varnished glass, Nero Marquinia marble, and black laquered oak - soft-polished black lacquered structure
- ← Roundel: piano in cristallo temperato extra chiaro retroverniciato e struttura laccata lucida bianca | top: extra clear tempered back-varnished glass and soft-polished white lacquered structure





- ↑ Roundel: piano in cristallo temperato extra chiaro retroverniciato, marmo Nero Marquinia e rovere laccato nero - struttura laccata lucida nera | top: extra clear tempered back-varnished glass, Nero Marquinia marble, and black laquered oak - soft-polished black lacquered structure
- ←



- ↑ Roundel: piano in cristallo temperato extra chiaro retroverniciato e struttura laccata lucida rossa  
Top in extra clear tempered back varnished glass and soft-polished red lacquered structure  
Sedia Kin | Kin chair
- ← Roundel: piano in cristallo temperato extra chiaro retroverniciato e struttura laccata lucida rossa  
Top in extra clear tempered back varnished glass and soft-polished red lacquered structure  
Sedia Mari 2015 | Mari 2015 chair



# FIRST

Baldessari e Baldessari

2019



Madam &amp; Milady | First

## First

Baldessari e Baldessari | 2019

First è una famiglia di tavoli versatili pensata sia per l'ambiente pranzo sia per l'home-office e l'ufficio. La linea continua del tubolare metallico a sezione circolare si svolge e disegna la struttura come un "filo d'Arianna", senza soluzione di continuità, aprendosi con una V in corrispondenza della gamba e generando una forma snella di curve e contro-curve. La palette di colori nella finitura satinata della struttura dialoga con i piani in MDF colorato in pasta e in combinazione con le diverse forme e dimensioni crea una gamma variegata di opportunità.

First is a family of tables for daily use in living rooms, home-office areas or workplaces. First is a table with continuous lines, composed of a metal tube with a circular section that "unfolds" and designs the table's structure; a sort of discontinuous "Ariadne's thread" that extends and opens into a "V" geometry at the leg. The colour palettes of the matt varnished metal matches with the coloured MDF tops. First tables are available in a range of dimension and shapes.



First

First Tavolo quadrato RAL 2001 | First square table RAL 2001



↑ Kin | First tavolo rotondo RAL 5020 | Kin | First Round table RAL 5020

← First tavolo rotondo RAL 5020 | First round table RAL 5020



Madam & Milady | First



# KIN

Radice Orlandini design studio

2018



Kin | Roundel | Miss Match

## Kin

Radice Orlandini design studio | 2018

Kin trae ispirazione dalla tecnica giapponese del Kintsugi che tende a valorizzare la rottura di un oggetto piuttosto che nasconderla. Così come da tradizione nipponica, i designer Radice e Orlandini hanno ricomposto in un'inedita soluzione estetica le diverse parti della struttura, che trasmettono l'impressione di un equilibrio apparentemente instabile. La struttura portante risulta nascosta alla vista e l'illusorio contrasto tra le varie parti può essere accentuato con finiture e materiali differenti. Tra i plus funzionali della discontinuità formale c'è un ridotto ingombro dei braccioli, in grado di offrire il giusto appoggio senza essere voluminosi e permettendo di posizionare comodamente la sedia sotto il tavolo.

The Kin chair takes inspiration from the Japanese Kintsugi technique, which tends to embrace the value of breakages rather than seeking to conceal them. Reflecting the Japanese tradition, designers Radice and Orlandini have taken the different parts of the frame and put them together in an unprecedented visual solution that conveys a sense of seemingly unstable balance. The bearing structure is hidden from view and the deceptive contrast between the parts can be emphasized with different materials and finishes. One of the practical benefits of the irregular shape is the compact size of the armrests, which provide sufficient support without being too bulky, allowing the chair to fit comfortably under a table.



Kin

Seduta con braccioli e schienale alto | Chair with armrests and high backrest



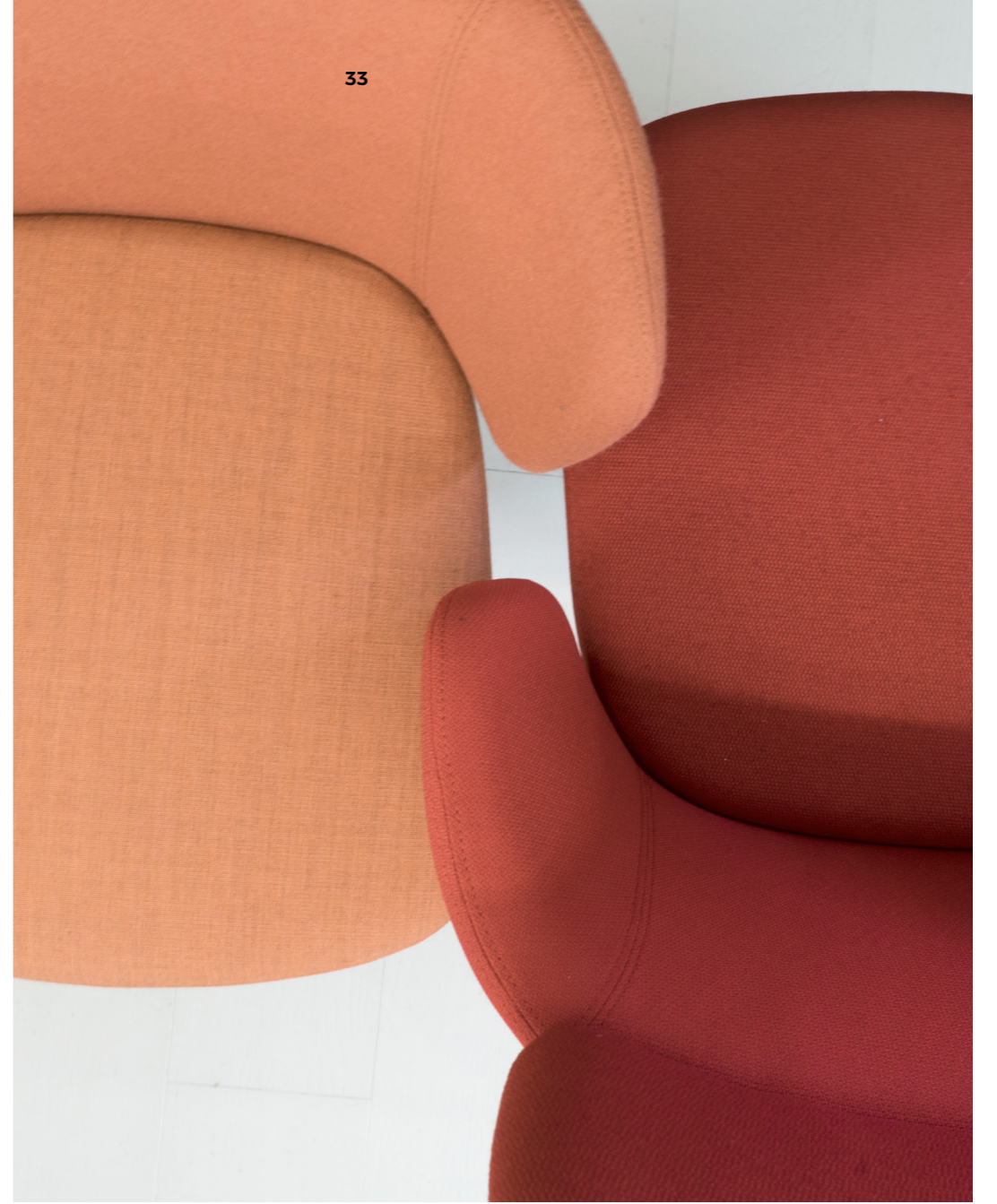

↑ Kin chairs (Dettaglio | Detail)

← Kin chair



# DONNA

Studio Irvine

2019



Roundel | Cartoons | Donna

## Donna

Studio Irvine | 2019

Donna nasce dalla ricerca della leggerezza per la creazione di un sistema: il risultato è una sedia agile, impilabile, capace di adattarsi a diversi tipi di ambienti e situazioni. La struttura snella in metallo accoglie la scocca grazie ad una sede nella parte posteriore dello schienale. La seduta, realizzata in metallo, può essere scelta in diverse versioni: con un pad morbido sulla sola parte anteriore, completamente imbottita oppure semplicemente mostrata nella sua essenzialità.

Donna was born out of a research for a lightness able to generate a system. The result is a chair that can easily fit into several different spaces and atmospheres. The slender metallic structure embraces the shell with a seat in the rear part of the backrest. The chair is made of metal and is available in several versions: the outdoor version is made of tone-on-tone or contrasting microperforated metal; the indoor version has a soft pad on the front that can be fully stuffed or not.



Donna

Sedia indoor con schienale e seduta rivestiti RAL 6021 | With upholstered seat indoor chair RAL 6021

# DONNA OUTDOOR

Studio Irvine

2019





↑ Sedia impilabile Outdoor&Indoor | Stackable chair Outdoor&Indoor  
RAL 1004 | RAL 6021 | RAL 3012

← Sedia impilabile Outdoor&Indoor | Stackable chair Outdoor&Indoor  
RAL 6021 | RAL 1004 | RAL 3031 | 3012



↑ Sedia impilabile Outdoor&Indoor | Stackable chair Outdoor&Indoor  
RAL 3031

← Sedia impilabile Outdoor&Indoor | Stackable chair Outdoor&Indoor  
RAL 3012



Donna | Cafè Costes

# **PALOMA**

Radice Orlandini design studio

2019







Paloma | Cafè Costes

## Paloma

Radice Orlandini design studio | 2019

Paloma, outdoor e indoor, trasforma in oggetto tridimensionale lo schizzo gestuale della matita, il segno grafico che fissa sul foglio l'idea di una sedia da un approccio minimale e libero da sovrascritture. Grazie all'immediato impatto emotivo sull'immaginario, è quasi un archetipo della sedia stessa. Un tubo piegato nello spazio disegna i contorni della sedia, fortemente visibili e caratterizzanti.

Paloma, outdoor and indoor, transforms a pencil sketch into a tangible object, a minimalist approach with no overwriting to make the drawing three dimensional. And so, a bent tube outlines the contours of the chair, highly connoting the product.



Paloma

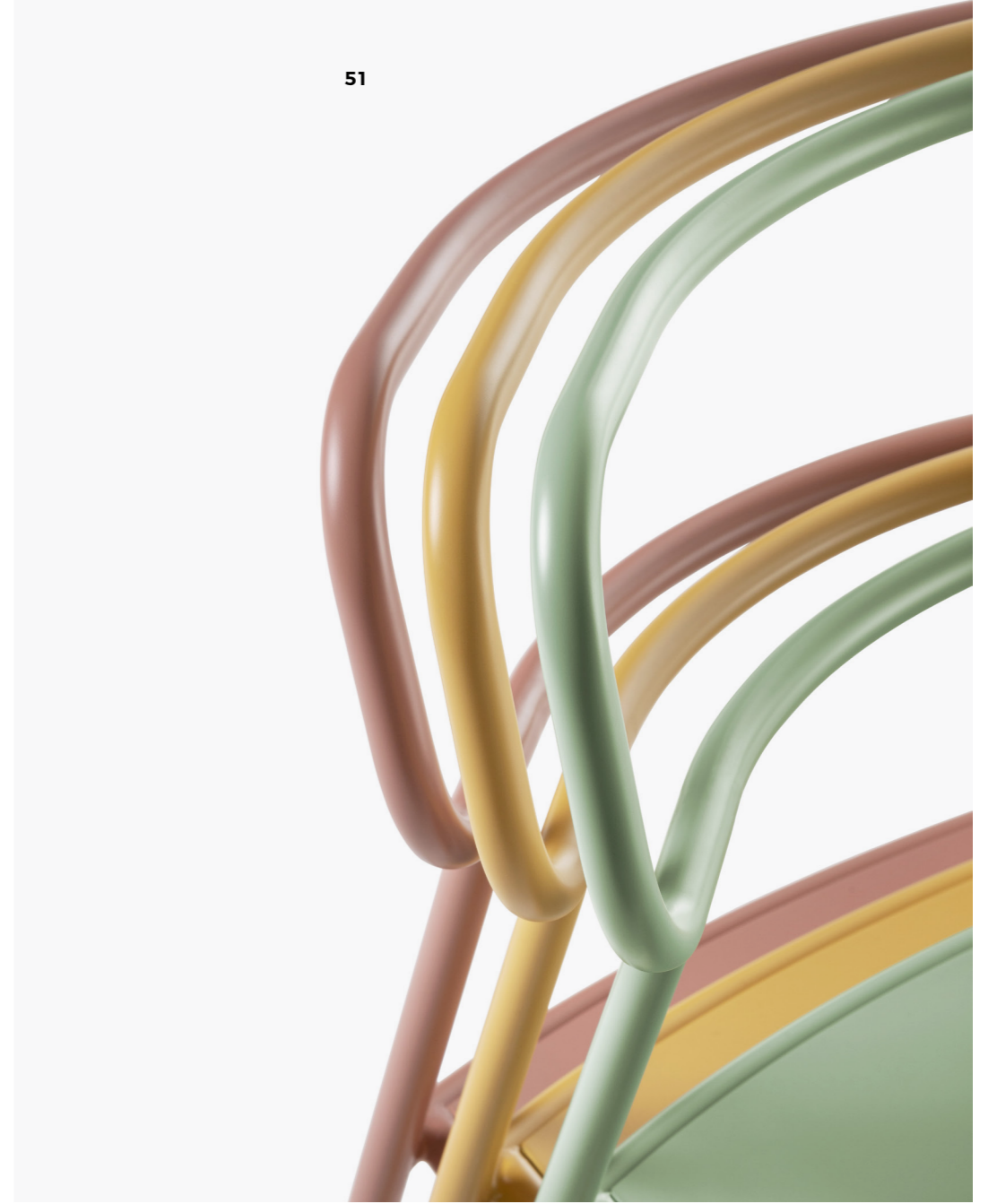

↑ Sedia impilabile Outdoor&Indoor | Stackable chair Outdoor&Indoor  
RAL 3012 | RAL 1004 | RAL 6021

← Sedia impilabile Outdoor&Indoor | Stackable chair Outdoor&Indoor  
RAL 6021



Donna | Paloma | Cafè Costes



# MADAM

Radice Orlandini design studio

2019

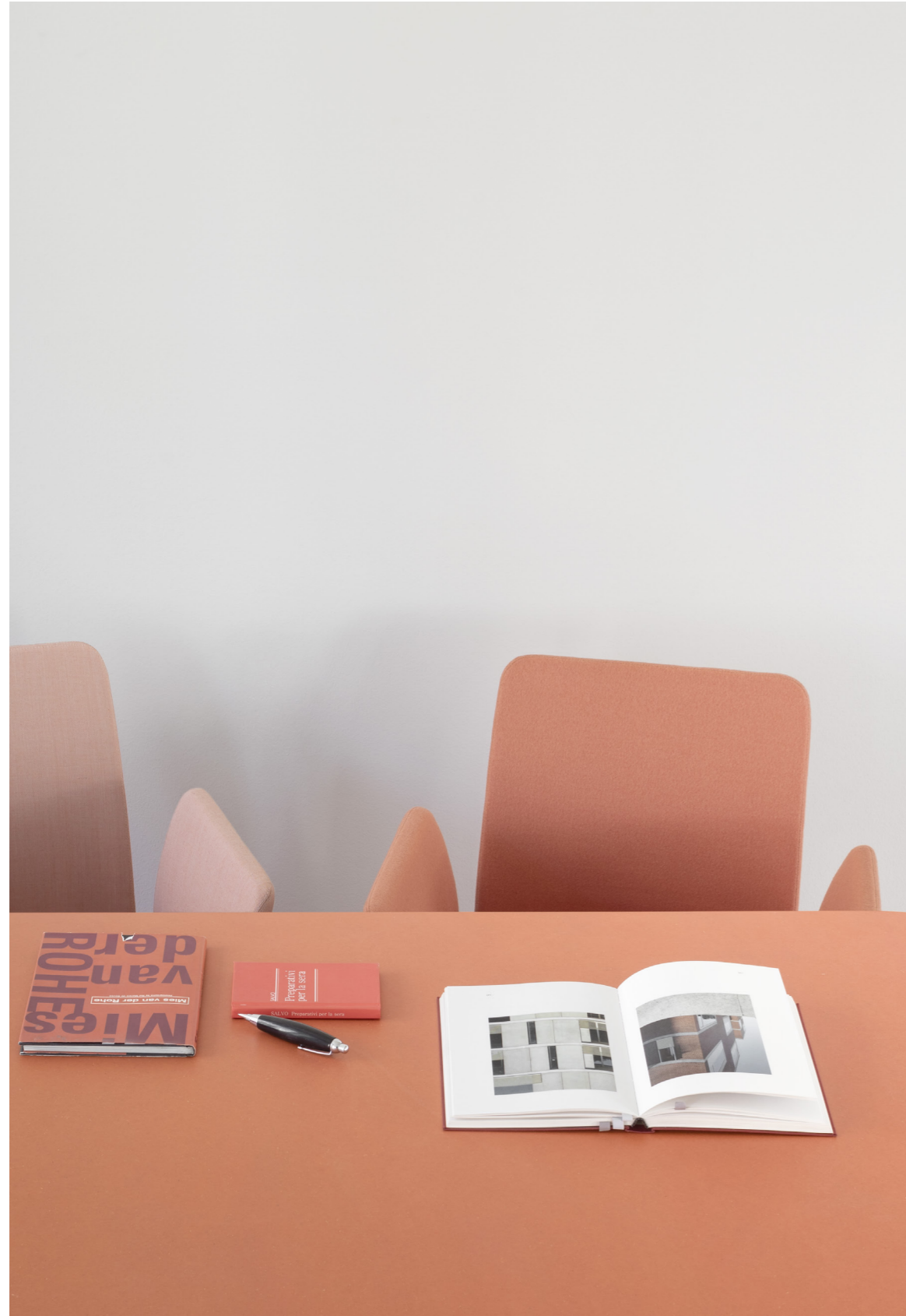

Madam | First

## Madam

Radice Orlandi design studio | 2019

Nata con l'obiettivo di alleggerire il più possibile il format del pozzetto, Madam è generata dalla scomposizione della massa dello schienale in tre: uno centrale più alto e due laterali più bassi con funzione di braccioli. I tre petali ridotti al minimo negli spessori, restano visibilmente separati e indipendenti creando una scocca leggera ed accogliente.

Born with the goal of lightening the format of the bucket seat as much as possible, Madam is created by decomposing the mass of the backrest into three "petals": a higher central one and two lower lateral ones that serve as armrests. The three petals are made as thin as possible, and become visibly separate and independent through the creation of a light and welcoming shell.



Madam

---

 Madam Poltrona | Armchair



# MILADY

Radice Orlandini design studio

2019



Milady | First

## Milady

Radice Orlandi design studio | 2019

Nata con l'obiettivo di alleggerire il più possibile il format del pozzetto, la seduta è generata dalla scomposizione della massa dello schienale in tre: uno centrale più alto e due laterali più bassi con funzione di braccioli. Milady rappresenta la versione ulteriormente alleggerita, che scopre le gambe su basamento centrale e lascia i petali sospesi a corolla attorno al sedile.

Born with the goal of lightening the format of the bucket seat as much as possible, this chair is created by decomposing the mass of the backrest into three "petals": a higher central one and two lower lateral ones that serve as armrests.

Milady represents a further lightened version, with visible legs on the central base and leaves the petals radiating from the seat.



Milady

Milady (base a 4 razze) | Milady ( 4 star base on glides)

# TAPE

Radice Orlandini design studio

2019





Tape | Picos

## Tape

Radice Orlandini design studio | 2019

La poltrona Tape nasce dall'incontro di due superfici imbottite e soffici che si piegano morbidamente nello spazio a formare seduta e schienale. Nessuna struttura a vista, ma solo due grandi cuscini conformati sulle forme del corpo per garantire il massimo comfort durante il relax. Nel punto di giunzione fra i due elementi le imbottiture si schiacciano sotto la spinta delle forze dinamiche. Un terzo elemento posizionato sotto la seduta completa il gioco di incastri fra le diverse masse e può essere usato a piacimento come piano d'appoggio laterale o come poggiatesta, trasformando la poltrona in una chaise-longue.

Tape is an armchair born of the meeting of two soft padded surfaces that bend softly in space to form the seat and back. It has no visible structure, just two large cushions shaped to hug the body and guarantee maximum comfort in complete relaxation. The padding flattens under the press of the dynamic forces at the junction between the two elements. A third cushion positioned under the seat completes the nesting of the volumes and can be used as a side table or as a footrest, transforming the armchair into a chaise-longue.



Tape

---

Chaise Longue | Chaise Longue



↑ Miss Match | Tape | Cartoons | Tato collection

← Miss Match | Tape | Cartoons



# KIN LOUNGE

Radice Orlandini design studio

2019



Kin lounge

## Kin lounge

Radice Orlandini design studio | 2019

Kin trae ispirazione dalla tecnica giapponese del Kintsugi che tende a valorizzare la rottura di un oggetto piuttosto che nasconderla. Così come da tradizione nipponica, i designer Radice e Orlandini hanno ricomposto in un'inedita soluzione estetica le diverse parti della struttura, che trasmettono l'impressione di un equilibrio apparentemente instabile. La struttura portante risulta nascosta alla vista e l'illusorio contrasto tra le varie parti può essere accentuato con finiture e materiali differenti. La versione lounge declina il concetto con proporzioni più comode.

The Kin seat takes inspiration from the Japanese Kintsugi technique, which tends to highlight the value of breakages rather than seeking to conceal them. Reflecting the Japanese tradition, designers Radice and Orlandini have taken the different parts of the frame and put them together in an unprecedented visual solution that conveys a sense of seemingly unstable balance. The load-bearing structure is hidden from view and the deceptive contrast between the parts can be emphasized with different materials and finishes. The lounge armchair declines the concept offering more comfort.



Kin lounge



# CHROMOSOME X & Y

Denis Santachiara

2018





Chromosome Y

## Chromosome X & Chromosome Y

Denis Santachiara | 2018

Chromosome X & Chromosome Y formano una inedita coppia di maxi sedute imbottite nata dalla volontà di suggerire nuove modalità di connotazione di uno spazio. Le caratteristiche forme X e Y di queste sedute informali permettono di creare diverse composizioni dinamiche attraverso la loro libera associazione in un ambiente, diventando cromosomi in libertà in grado di generare un nuovo DNA dell'abitare contemporaneo.

Chromosome X & Chromosome Y form an unprecedented pair of substantial padded seats stemming from the desire to put forward new ways of making a mark on settings. The distinctive X and Y shapes of the informal seats provide the scope to create a number of dynamic compositions because they can be arranged in any way and any location, thus making them free chromosomes that are capable of generating the new DNA of contemporary living.



Chromosome X &amp; Chromosome Y



↑ Chromosome X & Chromosome Y | Match Point  
← Chromosome X

# MISS MATCH

Claesson Koivisto Rune

2018







Miss Match | Match Point

## Miss Match

Claesson Koivisto Rune | 2018

Il divano è stato pensato come unione di semplici blocchi che si caratterizzano per un dettaglio particolare: una sottile irregolarità dovuta dalle dimensioni degli schienali in profondità ed altezza che variano di alcuni centimetri, mentre i piani di seduta e schienale rimangono sempre costanti. I sei elementi di seduta possono essere combinati in molteplici configurazioni e, grazie alle differenze delle singole unità accostate, il gioco dimensionale crea un effetto dinamico e caratteristico.

A take on the sofa involving a combination of simple blocks with a distinctive, distinguishing detail: a subtle irregularity due to the variations of a few centimetres in depth and height of the backrests, while the seat surfaces are always the same. The six seating units can be combined in numerous arrangements and the different dimensions of the individual pieces that come together create a striking, dynamic effect.



Miss Match

(Dettaglio | Detail)



↑ Miss Match (Dettaglio | Detail)  
 ← Miss Match



Miss Match | Tape | Tato Collection



# TRAYS

Parisotto + Formenton

2018



Trays | Picos | Madam &amp; Milady | First

## Trays

Parisotto + Formenton | 2018

Trays è un sistema di imbottiti per il living contemporaneo ispirato a forme del design degli anni '50 e concepito per offrire grande flessibilità di conformazioni per spazi sia privati sia hospitality. La famiglia - che include divani, poltrone, pouf e dormeuse - si distingue per linee asciutte ed essenziali, forme morbide e smussate. Elementi caratterizzanti sono una struttura sospesa e leggera che sostiene una piastra, elemento a vassoio che supporta la seduta e lo schienale, e il leggero scarto che si crea tra questa base e le cuscinature di seduta, generando un'asimmetria caratteristica.

Trays is a collection of upholstered furniture for contemporary living areas. It is inspired by 1950s design shapes and conceived to offer highly flexible arrangements for both private settings and hospitality. Simple, clean-cut lines and soft, rounded shapes are some of the distinguishing features of the collection, which includes sofas, armchairs, ottoman and daybed. The light, suspended structure holds up a tray that supports the seat and the backrest. A distinctive asymmetrical look is produced by the slight difference between this base and the seat cushions.



Trays

Detail Trays (Divano 3 posti | Sofa 3 seats)



Trays | Picos | Cartoons | Tato collection



↑ Trays (Divano 2 posti | Sofa 2 seats)  
 ← Trays (Divano 2 posti | Sofa 2 seats) | Match Point



↑ Trays (Poltrona + Pouf | Armchair + Ottoman)

← Poltrona | Armchair





↑ Trays (Dormeuse)

← Trays (Poltrona | Armchair) | Match Point



# PICOS

Claesson Koivisto Rune

2018



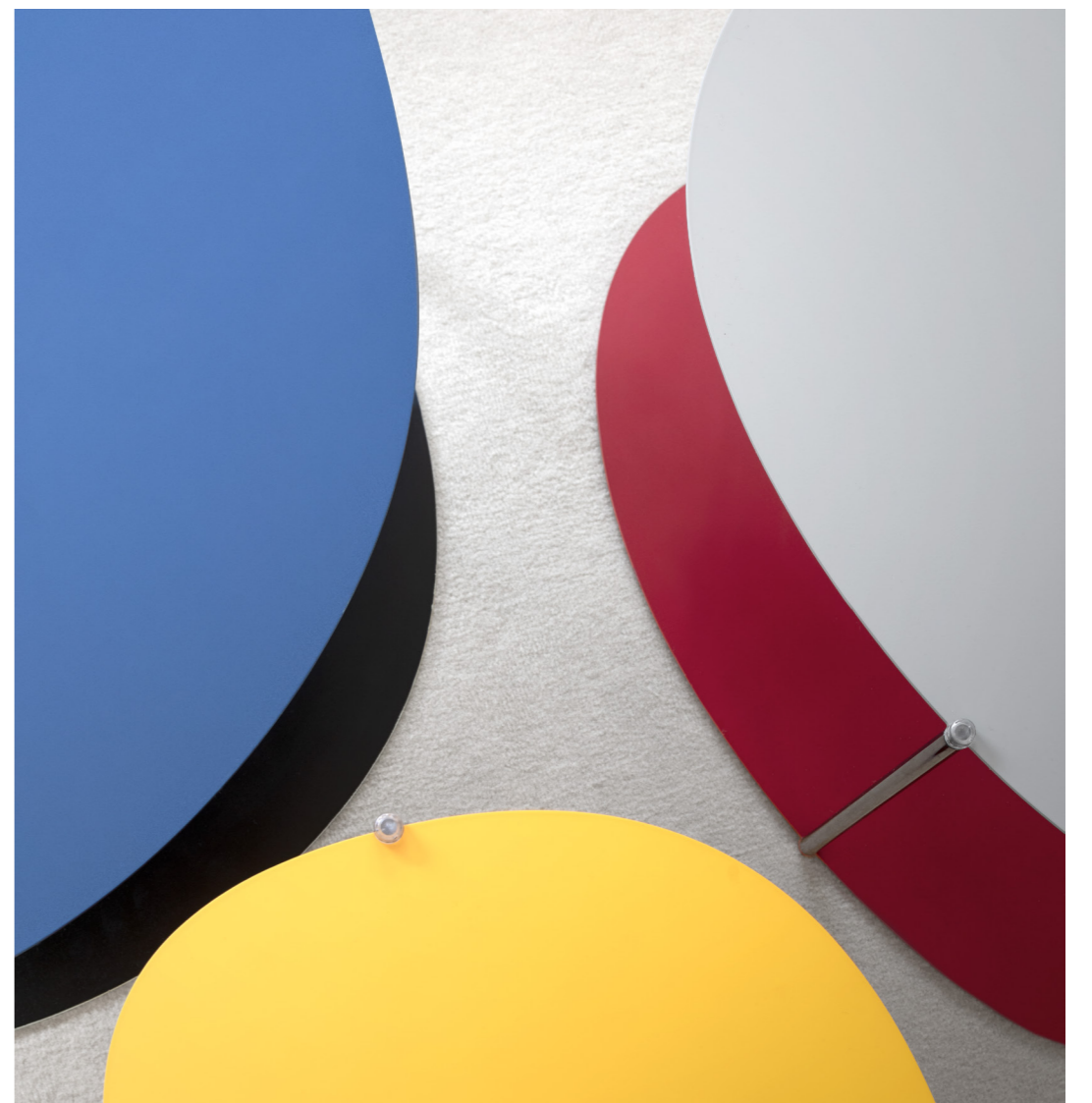
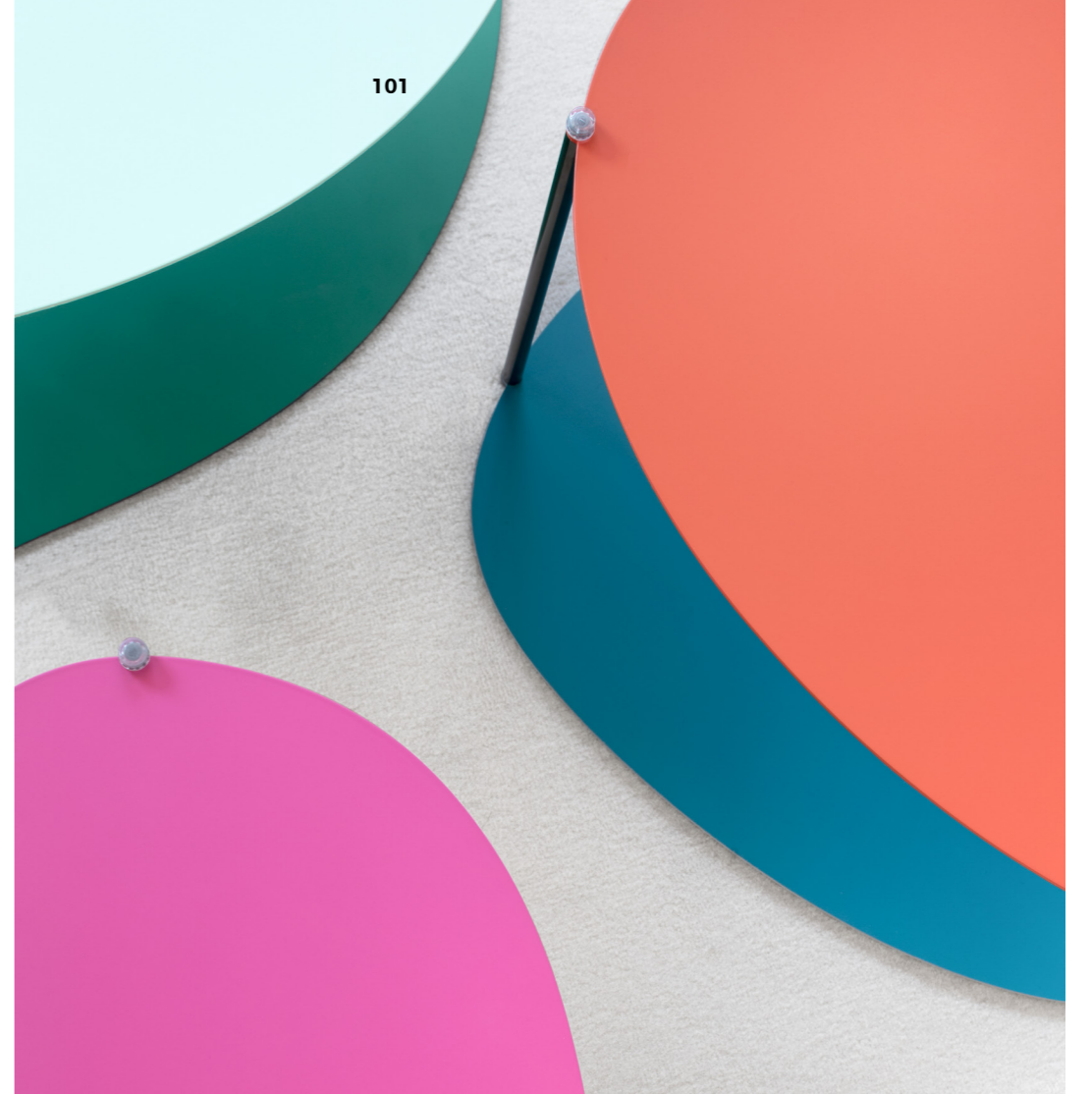



Picos (Large - Medium - Small)

## Picos

Claesson Koivisto Rune | 2018

Picos è una famiglia composta da tre tavolini bilaterali di diverse dimensioni. Una forma fluida e organica accomuna i modelli, ognuno dei quali presenta due piani di colori diversi, entrambi reversibili. Ogni elemento ha quindi un totale di quattro differenti colori, di cui solo due visibili contemporaneamente per infinite configurazioni.

There are three two-sided coffee tables in a choice of sizes in the Picos range. All of them have natural, flowing shapes and two tops in different colours, both of which are reversible. Therefore, in total four colours are available for each piece, although only two can be seen at a time for several creative combinations.



Picos

Large - Small



# MATCH POINT

Omri Revesz

2018

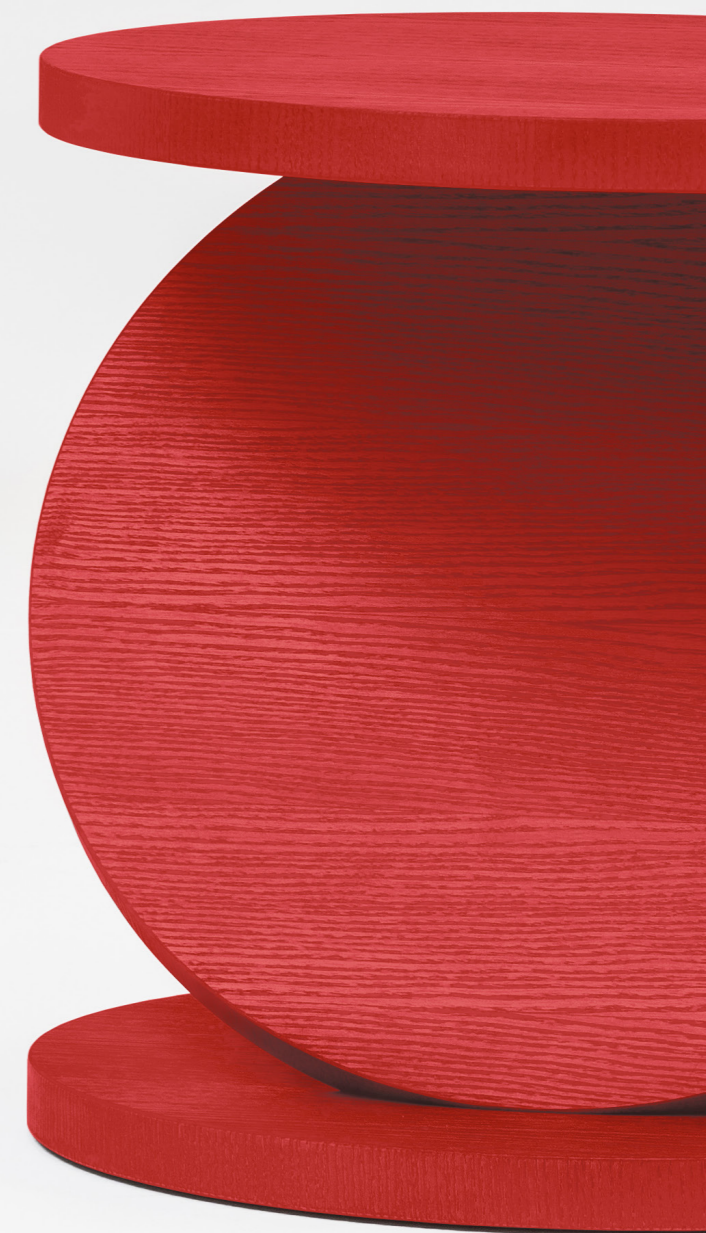



Match Point (Tall 90° | Medium 60° | Low 30°)

## Match Point

Omri Revesz | 2018

Geometrica ed essenziale, ma al tempo stesso dinamica, Match Point è una collezione di tavolini in legno massello in tre altezze con finiture naturali o colorate. Tre dischi circolari – tenuti insieme in equilibrio a 30, 60 e 90 gradi – danno vita a un prodotto funzionale e dalla presenza scultorea.

The geometrically shaped yet dynamic solid wood coffee tables in the Match Point collection come in three different heights and boast coloured or natural wooden finishes. Three circular discs – held together and balancing at 30, 60 and 90 degrees – are at the heart of the practical, sculptural products.



Match Point

Tall 90° | Medium 60° | Low 30°

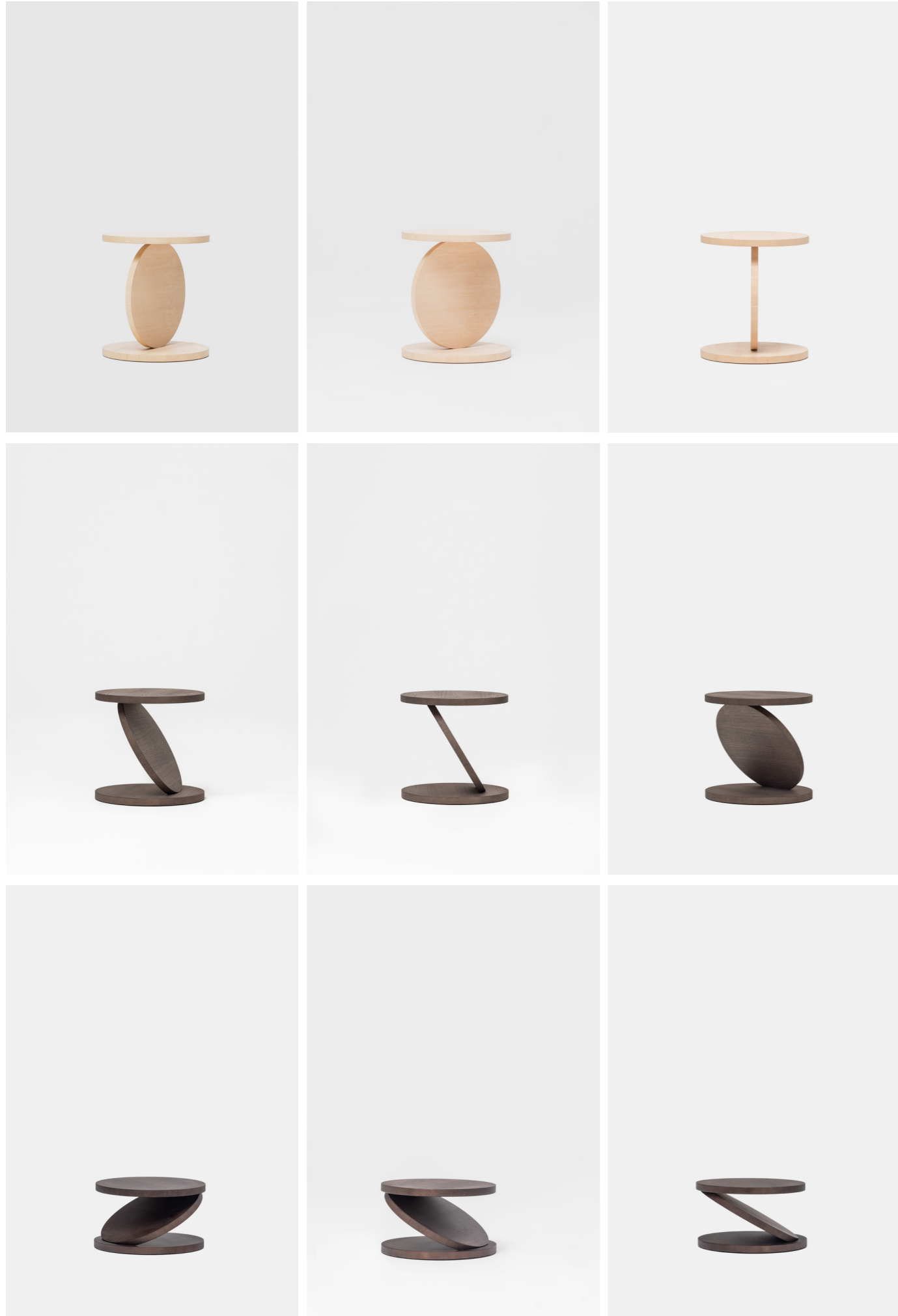

- ↑ Match Point
- ↳ Tavolino 90° alto | Tall 90° coffee table
- ↳ Tavolino 60° medio | Medium 60° coffee table
- ↳ Tavolino 30° basso | Low 30° coffee table

# GUIDA ILLUSTRATA

## Illustrated Guide

La collezione / Our collection

Roundel	P. 109
First	P. 110
Kin	P. 112
Donna	P. 113
Paloma	P. 114
Madam	P. 115
Milady	P. 116
Tape	P. 117
Kin lounge	P. 118
Chromosome X & Y	P. 119
Miss Match	P. 120
Trays	P. 122
Picos	P. 124
Match Point	P. 125



## Roundel

P.006-015

Tavolo tondo con gamba centrale. Struttura del sottopiano e della gamba centrale in poliuretano rigido strutturale, realizzati nelle finiture laccato lucido rosso, lucido bianco o semilucido nero. Il piano del tavolo può essere in cristallo temperato extra chiaro retroverniciato a cerchi concentrici rossi o bianchi, in tre toni di colore oppure a cerchi concentrici in legno impiallacciato rovere laccato nero semilucido, marmo Nero Marquinia lucido e cristallo extra chiaro retroverniciato nero.

A round table with a central leg. The sub-structure of the top and the central leg are made of rigid polyurethane with either a polished red, polished white or soft-polished black lacquered finish. The table top can be made of extra clear back-varnished tempered glass with concentric red or white circles, or with concentric discs of oak veneered wood with semi-gloss black lacquer coating, polished black Marquina marble and extra clear back-varnished black glass.

CKR201

Tavolo con piano in cristallo | Table with an extra clear tempered glass top

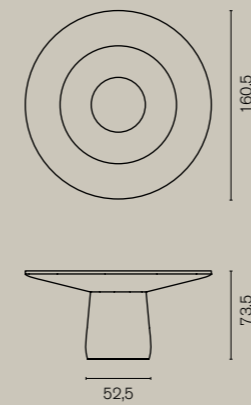

BB201

Configurazione 01 | Configuration 01

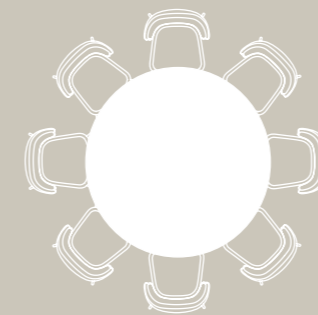

CKR202

Tavolo con piano in legno, marmo, cristallo | Table with a top made of wood, marble, clear glass

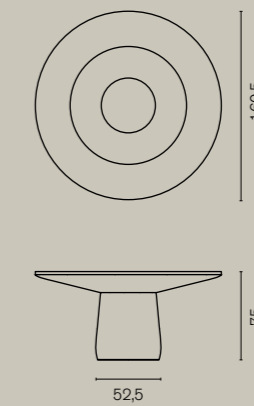

BB201

Configurazione 02 | Configuration 02

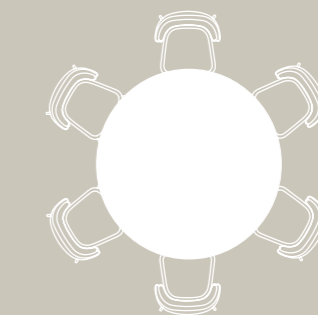

### Colori e materiali | Colors and materials



RAL 3003

RAL 9005

RAL 9001



disco piano in rovere laccato nero  
black lacquered oak top disc

disco top Nero Marquinia  
Nero Marquinia top disc

Struttura | Structure

Piano vetro retro verniciato  
Back varnished glass top

First

P.016-023

Tavolo con struttura in tubolare d'acciaio verniciato con polveri epossidiche e piano in MDF colorato in pasta nelle colorazioni blu (b), arancione (ar) e nero (n) con verniciatura opaca trasparente. La struttura è disponibile con verniciatura semilucida tono su tono.

Table with frame in tubular steel varnished with epoxy powders to match the top in MDF mass colored in blue (b), orange (ar) and black (n) protected with opaque transparent painting. The structure is available with tone-on-tone semi-gloss painting.

BB205  
Tavolo rettangolare 180x80 | Rectangular table 180x80

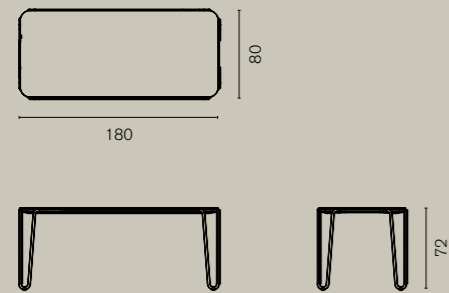

BB204  
Tavolo rettangolare 160x80 | Rectangular table 160x80

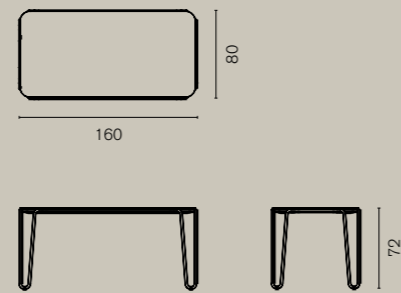

BB203  
Tavolo rettangolare 140x80 | Rectangular table 140x80

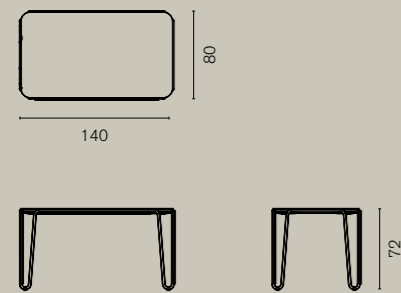

Colori struttura | Structure colors



RAL 5020



RAL 2001



RAL 9005

First

BB201  
Tavolo rotondo 120 | Round table 120

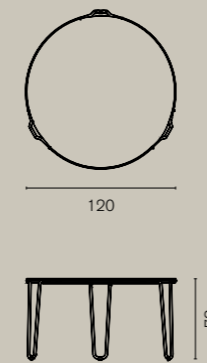

BB201  
Configurazione 01 | Configuration 01

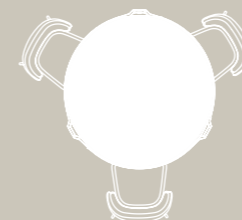

BB202  
Tavolo quadrato 160 | Square table 160

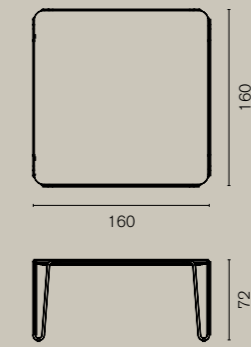

BB205  
Configurazione 02 | Configuration 02

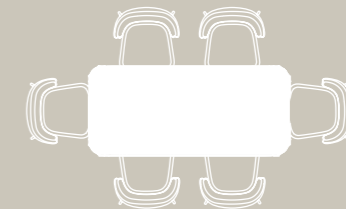

Colori piano MDF | MDF top Colors

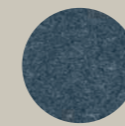

RAL 5020

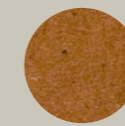

RAL 2001

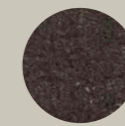

RAL 9005

## Kin

P.024-029

Sistema di sedute e sgabelli imbottiti con struttura in tubo di acciaio verniciato in polvere epossidica nero o grigio chiaro o cromato nero. Schienale in poliuretano schiumato a freddo. Rivestimento, non sfoderabile, in tessuto, pelle, ecopelle, pelle cliente (pc) o tessuto cliente (tc). Il sistema di sedute Kin è certificato con rivestimento in tessuto Step in conformità alla UNI 9175 e UNI 9175/FA1 in classe 1IM e in conformità al BS 7176: 2007+A1:2011 in classe "Rischio Medio".

A range of padded chairs and stools with structures made of light grey or anthracite grey epoxy powder coated or black chrome steel tubes. The covers are non-removable and they can be made of fabric, leather, artificial leather, customer leather (pc) or customer fabric (tc). The Kin seating system is certified with Step fabric covering in compliance with UNI 9175 and UNI 9175 / FA1 in class 1IM and with BS 7176: 2007 + A1: 2011 in the "Medium Hazard" class.

OD101/AG-N

Seduta con struttura verniciata | Chair with coated structure

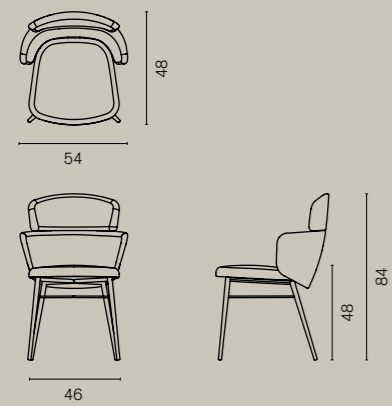

OD101/crm

Sedia con struttura cromata nera | Chair with black chrome structure

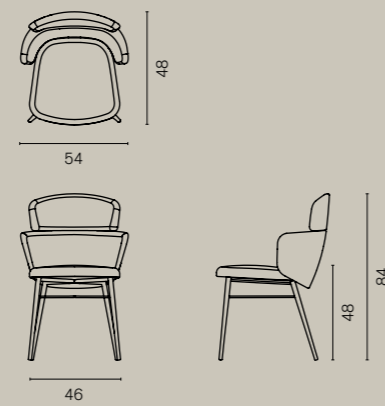

OD103/ag-n

Sgabello bar con schienale basso | Bar stool with low backrest

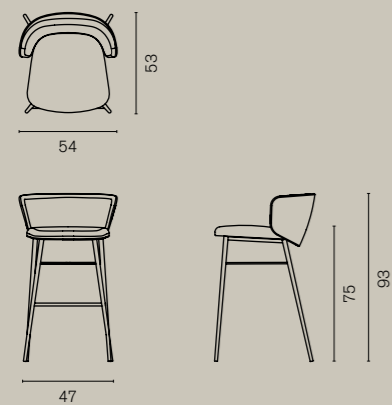

OD102/ag-n

Sgabello cucina con schienale basso | Kitchen stool with low backrest

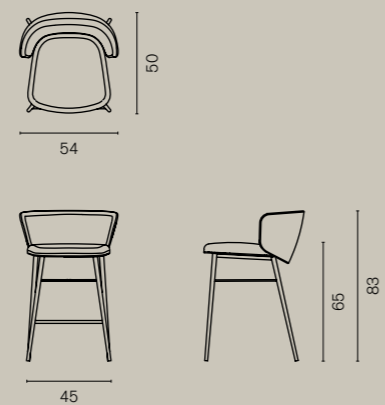

## Colori | Colors



RAL 9005

Opaco | Matt



RAL 9006

Opaco | Matt

Cromo nero  
Black Chrome

## Donna

P.030-041

Seduta con struttura in tubolare di acciaio, sedile e schienale in lamiera stampata e traforata verniciata con polveri epossidiche nei colori RAL 9005 opaco (n), RAL 9010 (w), RAL 3031 (ror), RAL 9018 (gc) tutti semilucidi, idonea per ambienti esterni. Disponibili anche versioni indoor con sedile e schienale in poliuretano schiumato a freddo senza CFC su un solo lato (ir102) oppure su entrambi (ir103). Rivestimento, non sfoderabile, in tessuto, tessuto tecnico, pelle, ecopelle, pelle cliente (pc) o tessuto cliente (tc).

Chair in steel tubular frame, with seat and backrest in molded and perforated sheet metal laquered to match the structure with epoxy powders in RAL 9005 matt(n), RAL 9010(w), RAL 3031(ror), RAL 9018(gc) all semi-gloss suitable for outdoor use, or for indoor use with seat and backrest filler in flexible polyurethane, cold-processed without CFC, on one side only (ir102) or on both sides (ir103). The covers are non-removable and they can be made of fabric, technical fabric, leather, artificial leather, customer leather (pc) or customer fabric.

IR103

Sedia interamente rivestita | Fully upholstered chair

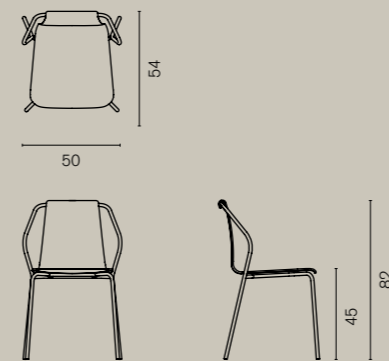

IR102

Sedia con rivestimento frontale | Chair with upholstered seat front

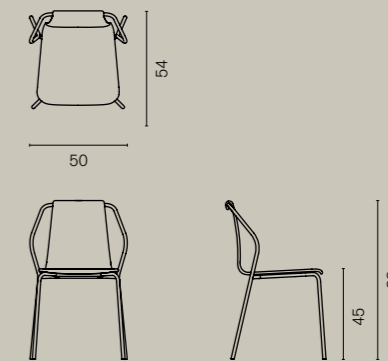

IR101

Sedia impilabile Outdoor&amp;Indoor | Stackable chair Outdoor&amp;Indoor

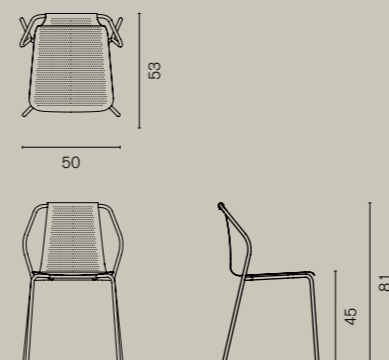

## Colori | Colors



RAL 9005

Opaco | Matt



RAL 9010

Semilucido | Semi-gloss



RAL 3031

Semilucido | Semi-gloss

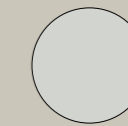

RAL 9018

Semilucido | Semi-gloss

## Paloma

P.042-049

Seduta con struttura in tubolare di acciaio e sedile in lamiera stampata verniciati con polveri epossidiche nei colori RAL9005 opaco (n), RAL 9010 (w), RAL 3031 (ror), RAL 9018 (gc) tutti semilucidi, idonea per ambienti esterni. Disponibili anche versioni indoor con solo sedile o sedile e schienale in poliuretano schiumato a freddo senza CFC. Rivestimento, non sfoderabile, in tessuto, tessuto tecnico, pelle, ecopelle, pelle cliente (pc) o tessuto cliente (tc).

OD104R/SE

Sedia con seduta rivestita | Chair with upholstered seat

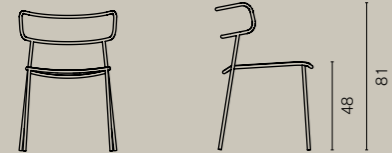
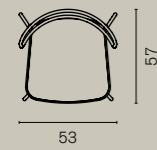

OD104R/SC

Sedia con schienale e seduta rivestiti | Chair - upholstered backrest and seat

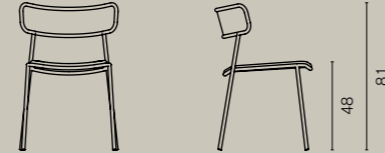
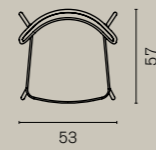

OD104R

Sedia impilabile Outdoor&amp;Indoor | Stackable outdoor&amp;indoor chair

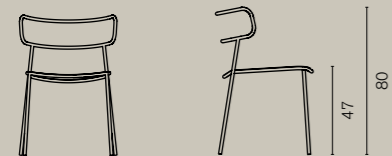
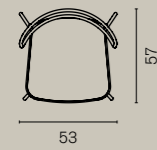

### Colori | Colors



RAL 9005

Opaco | Matt



RAL 9010

Semilucido | Semi-gloss



RAL 3031

Semilucido | Semi-gloss

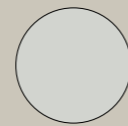

RAL 9018

Semilucido | Semi-gloss

## Madam

P.050-053

Poltrona con struttura in tubolare di acciaio e imbottitura in poliuretano flessibile schiumato a freddo senza CFC. Rivestimento, non sfoderabile, in tessuto, tessuto tecnico, pelle, ecopelle, pelle cliente (pc) o tessuto cliente (tc).

Armchair with structure in tubular steel, filler in flexible polyurethane, cold-processed without CFC. Non removable cover, in fabric, technical fabric, leather, synthetic leather, customer leather (pc), or customer fabric (tc).

OD105

Poltrona | Armchair

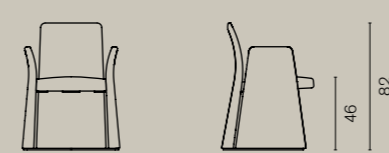

## Milady

P.054-057

Poltrona con struttura in tubolare di acciaio e imbottitura in poliuretano flessibile schiumato a freddo senza CFC. Rivestimento, non sfoderabile, in tessuto, tessuto tecnico, pelle, ecopelle, pelle cliente (pc) o tessuto cliente (tc). Base a 4 razze con finalini o a 4 razze con ruote.

Armchair with structure in tubular steel, filler in flexible polyurethane, cold-processed without CFC. Non removable cover, in fabric, technical fabric, leather, synthetic leather, customer leather (pc) or customer fabric (tc). 4 star base on glides or 4 star base on castors.

OD106/4R

Base a 4 razze | 4 star base on glides

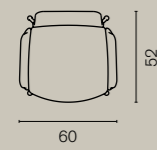

OD106/4RR

Base a 4 razze su ruote | 4 star base on castors

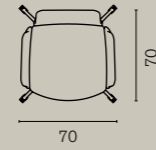

### Colori | Colors



RAL 9005

Opaco | Matt



RAL 9010

Semilucido | Semi-gloss

Alluminio lucidato  
Polished aluminum

## Tape

P.058-063

Poltrona con poggiatesta a scomparsa. Struttura interna in tubolare d'acciaio. Imbottitura in poliuretano flessibile, schiumato a freddo senza CFC. Rivestimento, non sfoderabile, in tessuto, tessuto sintetico, pelle, ecopelle, tessuto cliente (tc) o pelle cliente (pc).

Armchair with movable footrest. Internal structure in tubular steel. Filler in flexible polyurethane, cold-processed without CFC. Non removable cover, in fabric, technical fabric, leather, synthetic leather, customer leather (pc) or customer fabric (tc).

OD305

Poltrona | Armchair

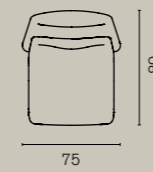

OD306

Pouf | Footrest

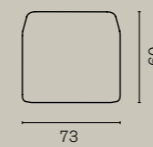

OD304

Chaise Longue | Chaise Longue

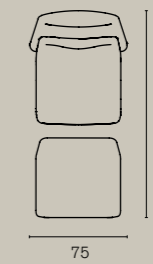

## Kin Lounge

P.064-067

Poltrona lounge con struttura in tubo di acciaio verniciato in polvere epossidica nero, grigio chiaro o cromato nero. Schienale in poliuretano schiumato a freddo. Rivestimento, non sfoderabile, in tessuto, pelle, ecopelle, pelle cliente (pc) o tessuto cliente (tc).

Il sistema di sedute Kin è certificato con rivestimento in tessuto Step in conformità alla UNI 9175 e UNI 9175/FA1 in classe 1IM e in conformità al BS 7176:2007+A1:2011 in classe "Rischio Medio".

OD307/AG-N

Poltrona con struttura verniciata | Armchair with coated structure

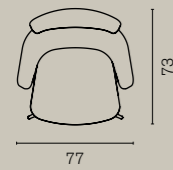

Armchair with structure made of light grey or anthracite grey epoxy powder coated or black chrome steel tubes. Flexible polyurethane backrest, cold, processed without CFC. The covers are non-removable and they can be made of fabric, leather, artificial leather, customer leather (pc) or customer fabric (tc).

The Kin seating system is certified with Step fabric covering in compliance with UNI 9175 and UNI 9175 / FA1 in class 1IM and with BS 7176: 2007 + A1: 2011 in the "Medium Hazard" class.

OD307/ACRN

Poltrona con struttura cromata nera | Armchair with black chrome structure

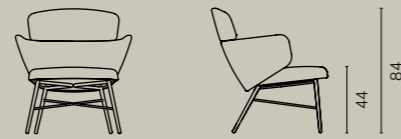
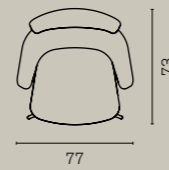

## Colori | Colors



RAL 9005

Opaco | Matt



RAL 9006

Opaco | Matt

Cromo nero  
Black Chrome

## Chromosome X &amp; Y

P.068-073

Sedute informali imbottite con struttura elastica realizzata in poliuretano flessibile, schiumato a freddo, con struttura interna rigida. Rivestimento completamente sfoderabile nella versione in tessuto. Possibilità di rivestimento in tessuto, pelle, ecopelle, pelle cliente (pc) o tessuto cliente (tc).

Informal padded seats with a flexible cold moulded polyurethane memory foam structure and a rigid internal frame. The fabric version has fully removable covers. The covers can be made of fabric, leather, artificial leather, customer leather (pc) or customer fabric (tc).

DS857

Pouf | Ottoman

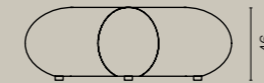
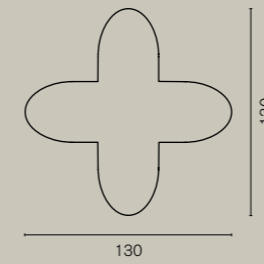

DS856

Pouf | Ottoman

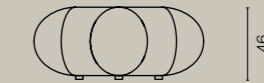
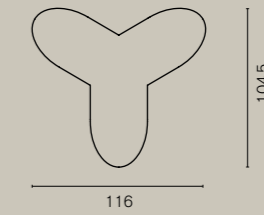

## Miss Match

P.074-081

Divano modulare composto da sette elementi liberamente configurabili con differenti altezze e profondità dello schienale. Struttura interna in legno multistrato e piedi in acciaio verniciato a polvere colore nero. Imbottitura in poliuretano espanso elastico e dracon. Molleggio a cinghie elastiche rinforzate. Rivestimento completamente sfoderabile nella versione in tessuto. Rivestimento in tessuto, pelle, ecopelle, pelle cliente (pc) o tessuto cliente (tc).

## CKR301 DX

Elemento terminale bracciolo dx | Right armrest end piece

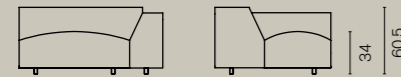
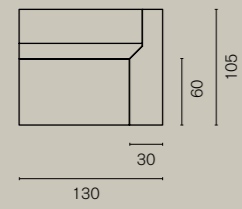

## CKR301 SX

Elemento terminale bracciolo sx | Left armrest end piece

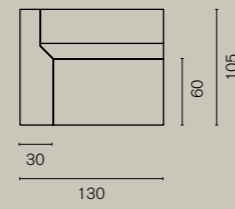

## CKR302

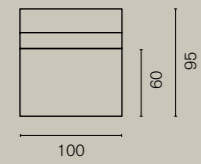
Elemento senza bracciolo S  
Section without armrest S

## CKR303

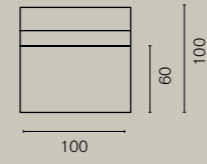
Elemento senza bracciolo L  
Section without armrest L

## CKR304

Elemento angolare | Corner section

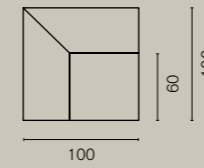

## CKR305

Elemento chill out | Chill-out section

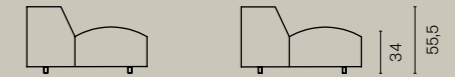
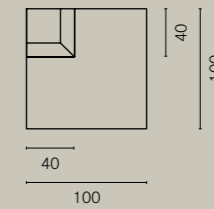

## CKR306

Elemento pouf | Ottoman

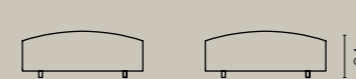
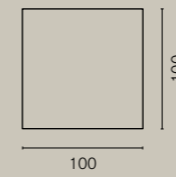

## CKR300/S

Cuscino piccolo | Small cushion

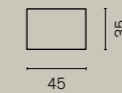

## CKR300/M

Cuscino medio | Medium cushion

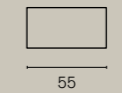

## CKR300/L

Cuscino grande | Large cushion

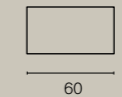

## Miss Match

A modular sofa made up of seven sections that can be freely arranged, with different heights and depths in the backrest. Plywood internal framework and steel feet with a black powder coating. Expanded polyurethane and Dacron padding. Reinforced elastic strap webbing. The fabric version has fully removable covers. The covers can be made of fabric, leather, artificial leather, customer leather (pc), customer fabric (tc).

## Trays

P.082-093

Poltrona, divano a due posti, poltrona tre posti, dormeuse con schienale e bracciolo a sinistra (sx) o a destra (dx) e pouf. Struttura interna in legno multistrato, piedi in acciaio verniciato a polvere colore nero. Imbottiture in poliuretano espanso elastico e dracon. I cuscini di seduta sono integrati nella struttura e realizzati in poliuretano espanso indeformabile a densità differenziate. Il rivestimento è completamente sfoderabile nella versione in tessuto. Possibilità di rivestimento in tessuto, pelle, ecopelle, pelle cliente (pc) o tessuto cliente (tc).

PF301

Poltrona | Armchair

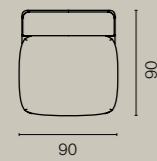

PF306

Pouf | Pouf

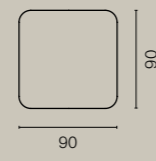

PF304 sx/dx

Dormeuse | Daybed

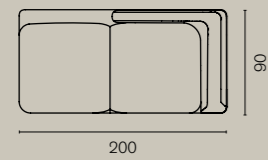

PF302

Divano 2 posti | Sofa 2 seats

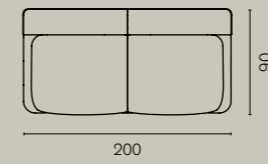

PF303

Divano 3 posti | Sofa 3 seats

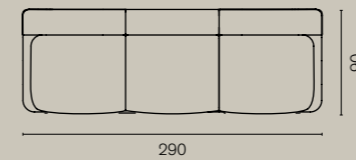

## Trays

Armchair, two-seater sofa, dormeuse with a backrest and an armrest on the left (sx) or right (dx), and a pouf. Plywood internal framework and steel feet with a black powder coating. Expanded polyurethane and Dacron padding. The seat cushions are built into the structure. They are made of polyurethane memory foam of varying densities. The fabric version has fully removable covers. The covers can be made of fabric, leather, artificial leather, customer leather (pc) or customer fabric (tc).

PF300

Cuscino | Cushion

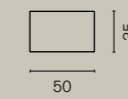

PF307 DX - PF 307 SX

Braccioli DX e SX | Right and left armrests

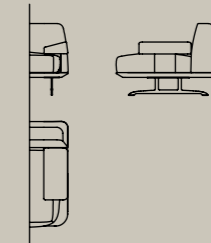



## Picos

P. 094-099

Tavolini reversibili di tre diverse dimensioni, con due piani realizzati in acciaio con spessore di 0,2 cm e con verniciatura a liquido su entrambe le superfici. I ripiani sono collegati da tondini in acciaio in finitura cromo nero lucido.

Reversible coffee tables in three different sizes, made of 0.2 cm thick steel and liquid coating on both surfaces. The tops are connected by round steel bars with polished black chrome finishes.

CKR203 L  
Tavolino grande | Large coffee table

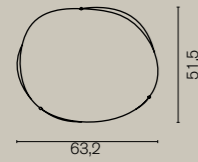

CKR203 M  
Tavolino medio | Medium coffee table

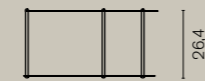
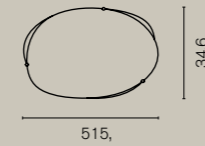

CKR203 S  
Tavolino piccolo | Small coffee table

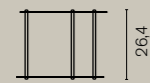
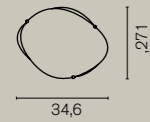

### Combinazioni cromatiche | Color combinations

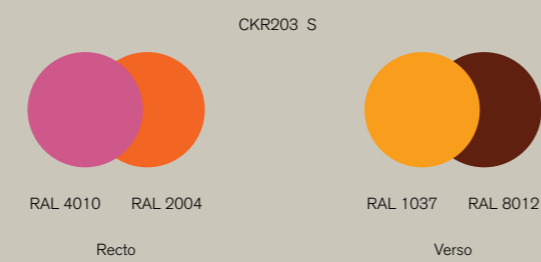

## Match Point

P. 100-105

Tavolini in legno multistrato impiallacciato in rovere sbiancato (rs), rovere termocotto (rt) o rovere laccato rosso (rl) a poro aperto.

Coffee tables made of plywood in bleached oak (rs), thermowood oak (rt), or open-pore red lacquered oak (rl).

OR201L  
Tavolino 90° alto | Tall 90° coffee table

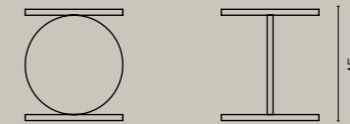
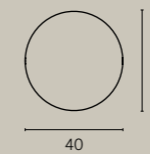

OR201M  
Tavolino 60° medio | Medium 60° coffee table

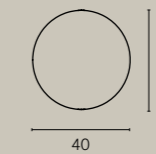

OR201S  
Tavolino 30° basso | Low 30° coffee table

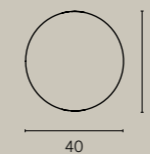

### Colori | Colors

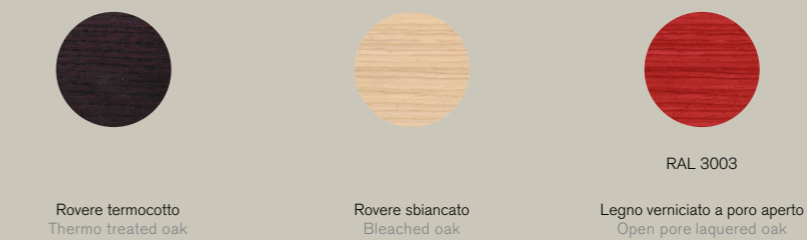

## INDICE TIPOLOGICO | INDEX BY TYPE

PRODOTTO   PRODUCT	DESIGNER	PAG.
<b>DIVANI E POUF   SOFAS &amp; OTTOMAN</b>		
Chromosome X & Y	Denis Santachiara	68
Miss Match	Claesson Koivisto Rune	74
Trays	Parisotto + Formenton	82
<b>POLTRONE LOUNGE LOUNGE CHAIRS</b>		
Tape	Radice Orlandini design studio	58
Kin lounge	Radice Orlandini design studio	64
<b>TAVOLI TABLES</b>		
Roundel	Claesson Koivisto Rune	06
First	Baldessari e Baldessari	16
<b>SEDIE CHAIRS</b>		
Kin	Radice Orlandini design studio	24
Donna	Studio Irvine	30
Paloma	Radice Orlandini design studio	42
Madam	Radice Orlandini design studio	50
Milady	Radice Orlandini design studio	54
<b>TAVOLINI COFFEE TABLES</b>		
Picos	Claesson Koivisto Rune	94
Match Point	Omri Revesz	100



è un marchio di | is a trademark of  
Baleri Italia S.r.l.

Sede legale | Registered office  
Via Borgonuovo, 16 - 20121 Milano  
P. iva: 10138480966

Sede operativa | Headquarter  
Via G. Verdi, 42 - 24060 Telgate (BG)  
P. iva: 10138480966

Baleri Italia si riserva il diritto di apportare le eventuali modifiche di parti e/o dettagli ritenute opportune per ragioni di carattere produttivo oppure commerciale. Tutti i diritti riservati. Copyright Baleri Italia. Modelli e Marchi depositati.

Baleri Italia reserves the right to make any modification of parts or details considered necessary with the aim of making improvements or for any other requirements of a constructive character.  
All rights reserved. Copyright Baleri Italia. Patent pending and registered trademarks.



Art director: Aldo Parisotto

Fotografie *Photography*

Alberto Strada  
Giulio Ghirardi  
Delfino Sisto Legnani & Marco Cappelletti  
Mauro Marciante

Styling  
Favaloro-Lucatelli  
P+F Architetti

Graphic Design  
P+F Architetti

Print  
Grafiche Antiga spa



è un marchio Baleri Italia S.r.l.  
*is a trademark of Baleri Italia S.r.l.*

Sede legale | *Registered office*  
Via Borgonuovo, 16 - 20121 Milano  
P. iva: 10138480966

Sede operativa | *Headquarter*  
Via G. Verdi, 42 - 24060 Telgate (BG)  
P. iva: 10138480966

[www.baleri-italia.it](http://www.baleri-italia.it)