

High
light of
fiche

lapalma

Preview

Light Office **Preview**

I TEMPI SONO CAMBIATI, **L'UFFICIO È LIGHT!**

I luoghi contemporanei del lavoro sono radicalmente cambiati. Nell'era della società liquida, anche l'ufficio ha mutato volto, per adattarsi a nuovi modi di lavorare, alle nuove tecnologie e ai nuovi ritmi delle persone. Il luogo di lavoro, quindi, non è più uno spazio tradizionale, con postazioni allineate e sequenziali. Ma è uno spazio articolato e leggero, multifunzionale e flessibile. Light Office.

Lapalma ha saputo cogliere il cambiamento, puntando sulla trasversalità dei suoi prodotti, che si adattano con facilità alle necessità di questi spazi, seguendo un processo di industrializzazione "custom oriented". E' questa un'idea nuova di ufficio leggero, che assembla con grande libertà arredi e moduli variabili, sceglie

diverse texture e finiture, accosta tessuti e materiali evocativi, compone gli spazi in modo fluido.

Una seduta da ufficio, allora, non avrà più soltanto un unico modello. Grazie alla possibilità di variare ogni sua parte – schienale, braccioli, gambe, stoffe, materiali – diventa una famiglia di prodotti molto versatile, capace di rispondere a molteplici configurazioni spaziali e diverse esigenze organizzative: la sala d'aspetto, la seduta per riunioni, la sedia direzionale, la postazione operativa.

Grazie all'abaco articolato dei prodotti Lapalma, si possono comporre e abbinare, con grande flessibilità, elementi di arredo, scrivanie e tavoli a diverse altezze, contenitori da ufficio e accessori funzionali, per creare un

ufficio a propria misura e in linea con i tempi.

Lapalma reinventa un ufficio contemporaneo e disinvolto, con arredi minimal che si riscaldano nei dettagli, nei materiali, nella scelta cromatica. Nella sua linea di prodotti per il Light Office, Lapalma propone un nuovo concetto di spazio di lavoro, dove le gerarchie sono sfumate, le funzioni non sono più rigidamente separate e il comfort diventa più informale e democratico: il cliente si siede su una panca imbottita, i documenti sono riposti in armadi colorati, il cablaggio è collocato in contenitori sollevati da terra. Con leggerezza, l'ufficio è cambiato: Time is changed, the office is light!

TIMES ARE CHANGING, OFFICE IS LIGHT !

Contemporary working places have totally changed. In the age of a more fluid society, the office too has changed and has adapted itself to the new ways of working, new technologies and the new rhythm of people. The work place is therefore no longer a traditional space with regimented desking, but a light, well-structured, multifunctional and flexible space. It is a Light Office.

Lapalma are able to capture this need for change by offering a range of cross-over products which can be easily adapted to the spaces and by using their established industrial processes set up to provide customized solutions.

This is a new idea of light office, which freely combines furniture with flexible elements, choosing different textures and finishes, matching fabrics with suggestive materials to configure the spaces in a fluid way.

An office chair then will not just be a single model; thanks to the possibility of changing each of its parts – backrest, arms, base, fabric, materials - it becomes a multipurpose family of products, capable of responding to many spatial configurations and new organization requirements: the waiting room, the meeting room, the executive chair, the task chair.

Thanks to the range and variety of Lapalma's products, seating, tables, desks can be combined, matched with functional storage to make a tailored office for the contemporary time.

Lapalma reinvents a contemporary and relaxed office, offering furniture of a clean design but also genial and inviting with careful attention to detail and a range of finishes and fabrics with warmth and colour.

With its range for the Light Office, Lapalma suggests a new concept of shared work space, where hierarchies are blended, functions are no longer strictly separated and comfort becomes informal and democratic. With lightness, the lifting of formality, the office has changed: times are changing, the office is light !

DIE ZEITEN ÄNDERN SICH, DAS BÜRO WIRD LIGHT !

Die Arbeitslandschaft hat sich in den letzten Jahren grundlegend verändert. In einer im ständigen Wandel begriffenen Gesellschaft, verändert sich auch das Erscheinungsbild der Arbeitsplätze. Sie werden an neue Arbeitsformen und -rhythmen angepasst und tragen den neuen Kommunikationsmitteln Rechnung. Das klassische Büro mit Schreibtischen in Reih und Glied weicht immer mehr einem offenen, multifunktionalen Raum, der nach Bedarf flexibel gestaltet werden kann: das „Light Office“.

Lapalma hat diese Veränderungen wahrgenommen und entwirft daher vielseitig einsetzbare Produkte, die leicht an die verschiedenen Raumgegebenheiten angepasst werden können. Dadurch werden sie trotz industrieller Fertigung den Bedürfnissen der Benutzer gerecht.

Diese neue Sichtweise des „Büros“ offenbart große Gestaltungsfreiheit: verschiedene Einrichtungsgegenstände werden in variablen Modulen zusammengestellt, Materialien und Ausführungen frei gewählt und Stoffe mit anderen Materialien zu ausdrucksstarken Kombinationen vereint. Dies schafft fließenden Übergänge innerhalb der Räume.

Auch ein Bürostuhl kann daher nicht mehr nur als „fertiges“ Modell angeboten werden, sondern muss die Möglichkeit bieten, die einzelnen Komponenten – Rückenlehne, Armlehnen, Gestell – aber auch verschiedene Bezugsstoffe frei zu wählen. Dadurch entsteht ein vielseitig einsetzbares Produkt, sozusagen eine „Stuhlfamilie“, die sich an die verschiedensten Raumgegebenheiten und Bedürfnisse anpassen lässt: Warte Räume, Besprechungszimmer, Direktionsbüros oder Arbeitsplätze für Angestellte können damit ausgestattet werden.

Lapalmas breit gefächertes Angebot bietet die Möglichkeit Schreib- oder andere Tische mit unterschiedlichen Höhen, Stauraumelemente und verschiedenes Zubehör zu kombinieren, um das Büro den eigenen Bedürfnissen und dem Zeitgeist entsprechend einzurichten.

Lapalma denkt das „Büro“ neu - modern und unkompliziert - mit einer aufs Minimum beschränkten Einrichtung, die jedoch durch besondere Details, ausgefallene Materialien oder Farben besticht.

Mit der neuen Produktlinie für das „Light Office“ zielt Lapalma auf ein neues Konzept für den Arbeitsplatz ab: Hierarchien lösen sich auf, die einzelnen Aufgabenbereiche sind nicht mehr streng getrennt und Komfort sowie die Möglichkeit zu informeller Begegnung werden immer wichtiger. So sitzt der Kunde auf einer gepolsterten Bank, Dokumente werden in farbenfrohen Schränken aufbewahrt und Kabel „versteckt“. Das „Büro“ hat sich ganz einfach verändert: times are changing, office is light !

LES TEMPS VONT CHANGER, LE BUREAU EST LIGHT !

Les lieux de travail contemporains sont en pleine mutation. A l'ère d'une société en mouvement, fluide comme de l'eau, le bureau a lui aussi changé d'aspect pour s'adapter aux nouvelles façons de travailler, aux nouvelles technologies et pour accompagner les nouveaux rythmes de vie des personnes. Le lieu de travail n'est plus un espace traditionnel avec des stations alignées, mais un espace articulé, léger, multifonctionnel, évolutif et flexible : est né le Light office.

Lapalma a su accueillir ce changement en proposant des produits transversaux qui s'adaptent facilement aux besoins de ces espaces grâce à un procès d'industrialisation dit «custom oriented».

Ceci est la nouvelle conception du Light office, qui réunit avec une grande liberté meubles et assises modulables, mixte différents choix de couleurs et de textures, assemble tissus et matériaux, compose des espaces fluides.

Une chaise de bureau, donc, ne se déclinera pas en une seule version. Grâce à la possibilité de changer chaque partie (dossier, accoudoirs, piètements, tissus, matériaux), la chaise devient une famille de produits adaptables capable de répondre à plusieurs configurations : salle d'attente, salle réunion, siège de direction, poste de travail.

Les produits Lapalma, peuvent être composés avec une grande flexibilité : éléments, bureaux et tables de différentes hauteurs, éléments conteneurs, accessoires fonctionnels sont là pour créer un bureau sur mesure et de grande actualité. Lapalma décline un bureau contemporain et astucieux qui s'enrichit de détails, de matériaux et d'un vaste choix de couleurs.

Dans la gamme de produits pensés pour le Light Office, Lapalma propose un nouveau concept d'espace de travail, dans lequel les hiérarchies s'estompent, les fonctions ne sont plus rigidement séparées, où le confort devient informel et démocratique : le client est assis dans une banquette rembourrée, les documents sont classés dans des armoires colorées, les câbles stockés dans des conteneurs adaptés. Avec légèreté le bureau a changé : les temps ont changé et le bureau est devenu light !

LOS TIEMPOS CAMBIAN, LA OFICINA ES LIGERA !

Los ambientes contemporáneos de trabajo están cambiando de manera radical. En la era de la sociedad líquida, también las oficinas han cambiado la cara, para adaptarse a nuevas formas de trabajo, a las nuevas tecnologías y a los nuevos ritmos de las personas. El ambiente de trabajo, non es más un espacio tradicional, con los puestos alineados y en secuencia. Más bien un espacio articulado y ligero, multifuncional y flexible. Light Office.

Lapalma ha sabido coger el cambio, concentrándose en la transversalidad de sus productos, que se adaptan con facilidad a las necesidades de estos espacios, siguiendo la producción industrial "custom oriented". Esta es la nueva idea de oficinas ligeras, que ensambla con grande libertad muebles y módulos variables, elige diferentes texturas y acabados - convirtiéndose en una familia muy versátil de productos, capaz de responder a múltiples configuraciones de espacios y diferentes exigencias organizativas: la sala de espera, de reuniones, la silla del director de la empresa o para un puesto operativo.

Gracias a la posibilidad de variar sus partes – respaldo, apoya brazos, base, tejidos, acabados - convirtiéndose en una familia muy versátil de productos, capaz de responder a múltiples configuraciones de espacios y diferentes exigencias organizativas: la sala de espera, de reuniones, la silla del director de la empresa o para un puesto operativo. Gracias al ábaco articulado de los productos Lapalma, se pueden componer e combinar, con grande flexibilidad, elementos de mobiliario, escritorios y mesas en diferentes alturas, contenedores de oficinas e accesorios funcionales, para crear una oficina a medida del cliente y de acuerdo con los tiempos.

Lapalma reinventa una oficina contemporánea y casual, con muebles minimalistas que se destacan en los detalles, los materiales y la elección cromática de los colores.

En su línea de productos para Light Office, Lapalma propone un nuevo concepto de espacios de trabajo, donde las jerarquías no se demarcan, las funciones no son rigidamente separadas y el confort se vuelve más informal y democrático: el cliente se sienta en un sofá tapizado, los documentos son archivados en armarios de colores, los cables son colocados en contenedores elevados del suelo.

Los tiempos cambian, la oficina es ligera: Times are changing, office is light !





Index

ADD Francesco Rota 2014	13
ADD T Francesco Rota 2016	29
ADD S Francesco Rota 2016	51
ADD SYSTEM Francesco Rota 2016	63
UNO Francesco Rota 2016	81
FRAME Romano Marcato 2007	97
SCREEN Francesco Rota 2016	107
ZA SYSTEM Shin & Tomoko Azumi 2003	125
KIPU Anderssen & Voll 2014	135
LAB Karri Monni 2014	143
BRUNCH Romano Marcato 2012	153

ADD

Francesco Rota | 2014











ADD

Francesco Rota | 2014



High table

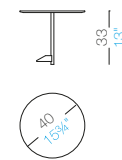
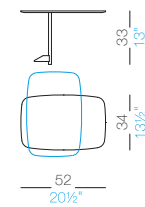

Legs

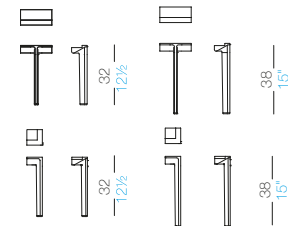

Tablet accessories

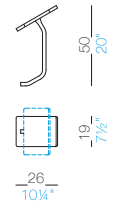

Charging tray unit

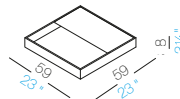

Magazine unit

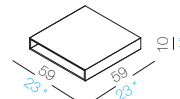

Tray

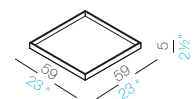

Frames

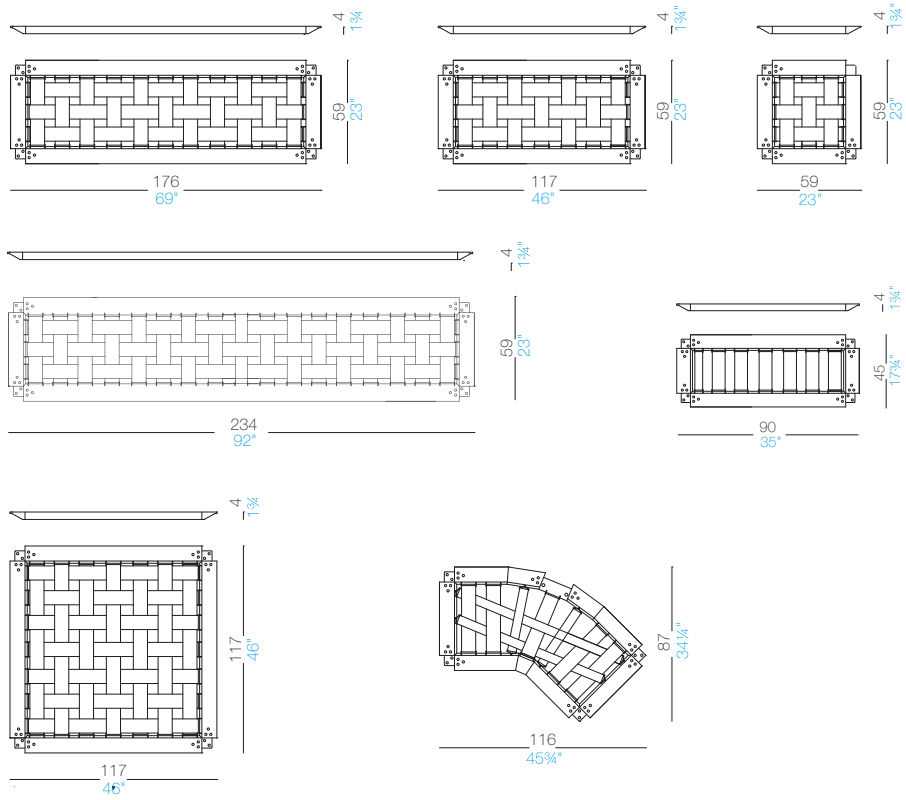

Backs

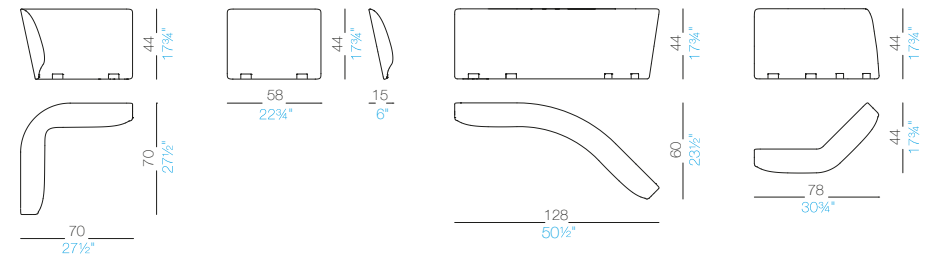

Seats

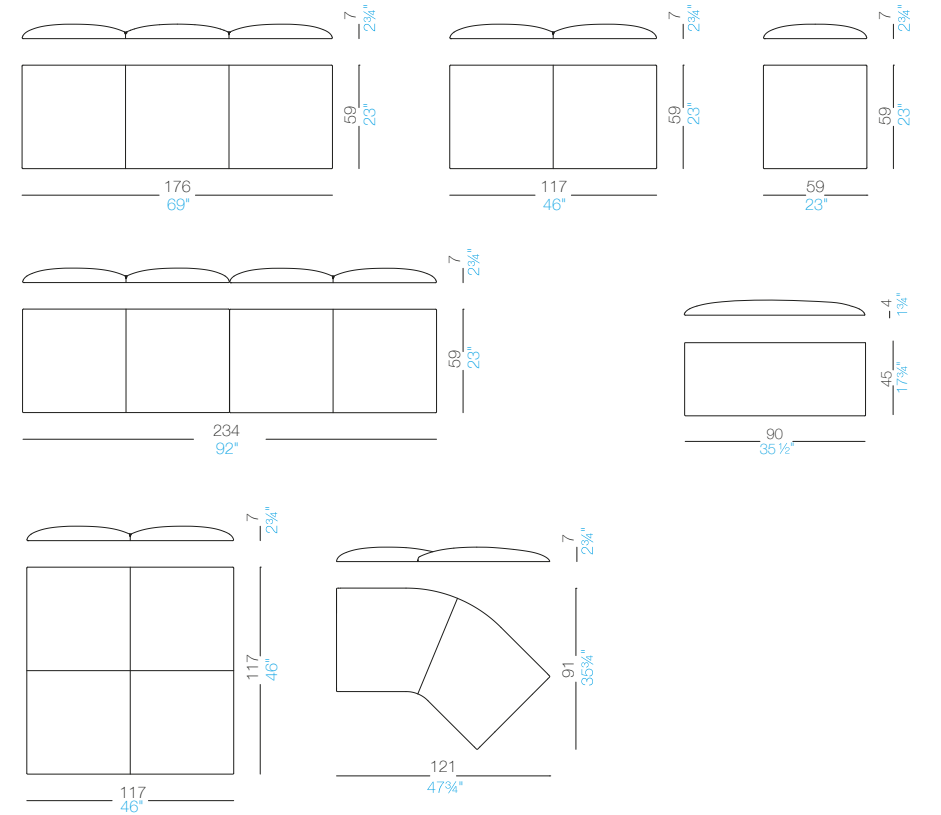

Table frames

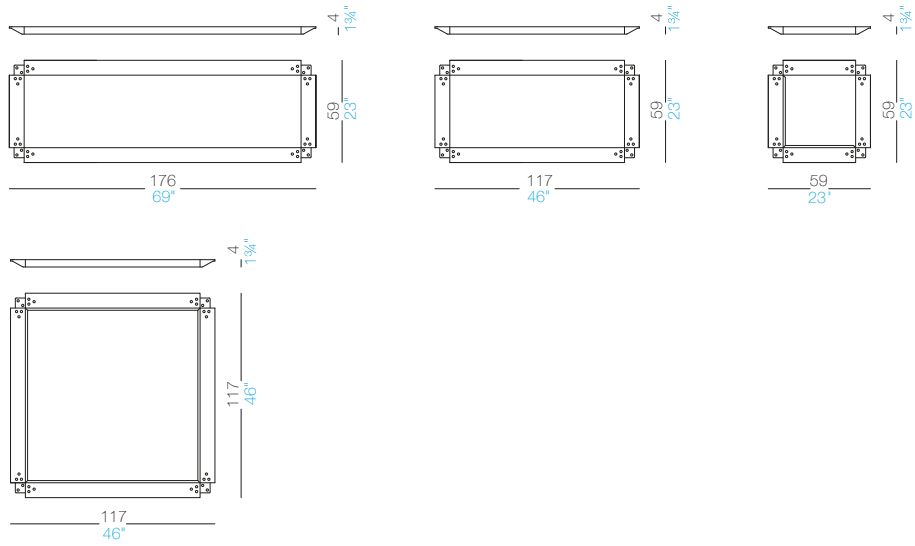
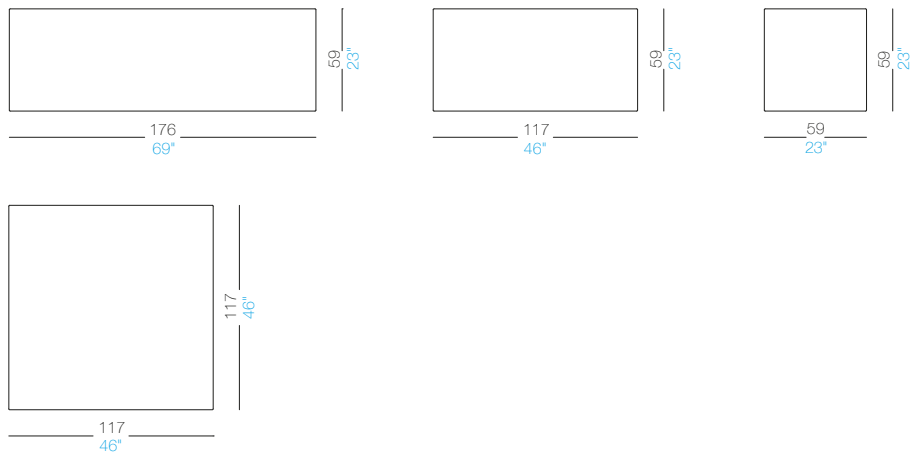

Table top



Vis à vis – small



Classic mini – double

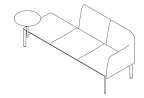

Classic

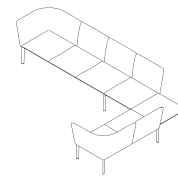

L_shape – open

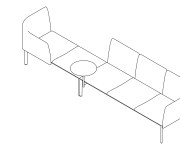

Vis à vis-big

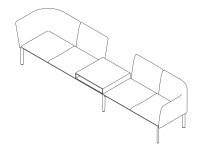

Side by side

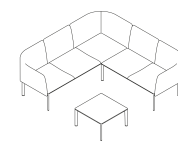

L_shape – big

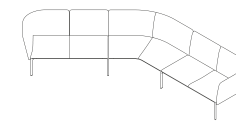

V_shape in

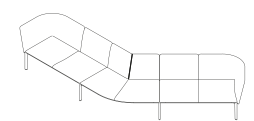

V_shape out

ADD

Sample configuration

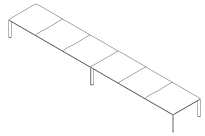

Long bench

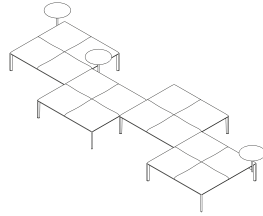

Square bench system

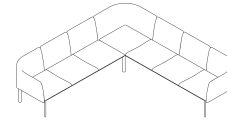

Mirror_shape

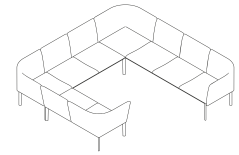

Square_shape

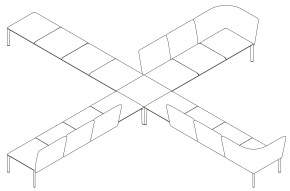

X_shape

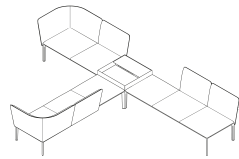

T_shape

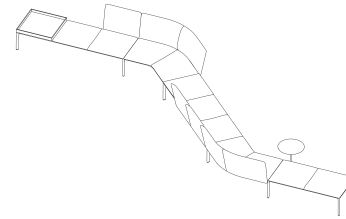

S_shape

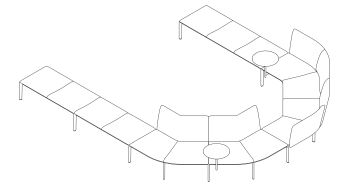

U_shape

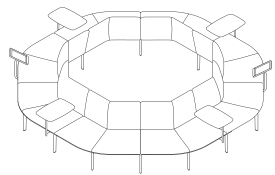

Round out

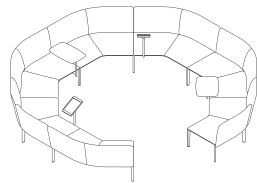

Round in

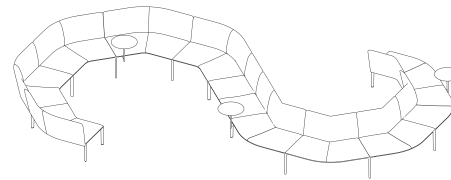

S_shape big

ADD T

Francesco Rota | 2016











lapalma







ADD T

Francesco Rota | 2016

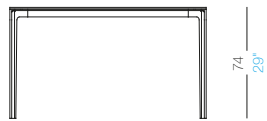

74
29"

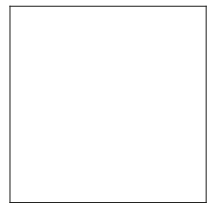

130 ÷ 160 ÷ 180
51" ÷ 63" ÷ 71"

130 ÷ 160 ÷ 180
51" ÷ 63" ÷ 71"

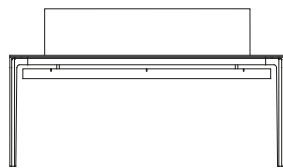

74
29"

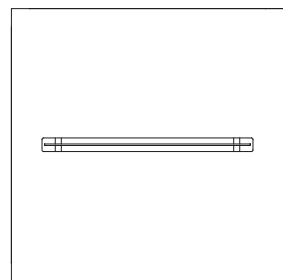

180
71"

180
71"



74
29"



90
35 1/2"

160 ÷ 180 ÷ 200
63" ÷ 71" ÷ 78"



74
29"



110
43 3/8"

250 ÷ 300
98 1/2" ÷ 118"



74
29"



110
43 3/8"

300 ÷ 360 ÷ 420
118" ÷ 142" ÷ 165"

ADD T

Francesco Rota | 2016

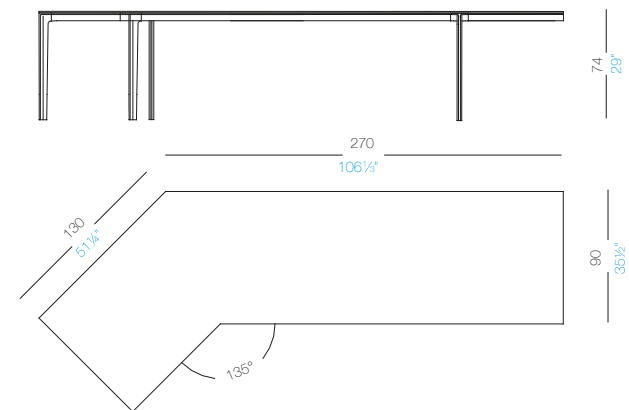
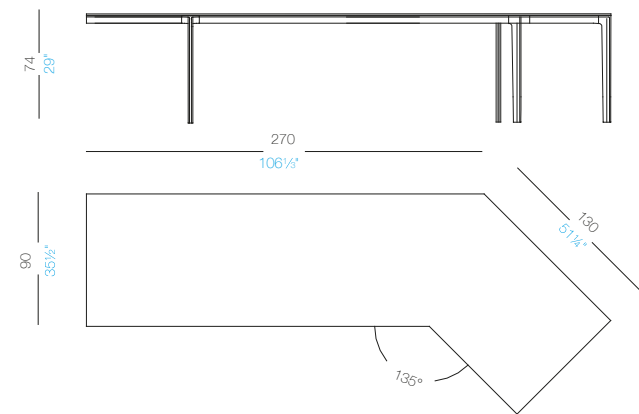
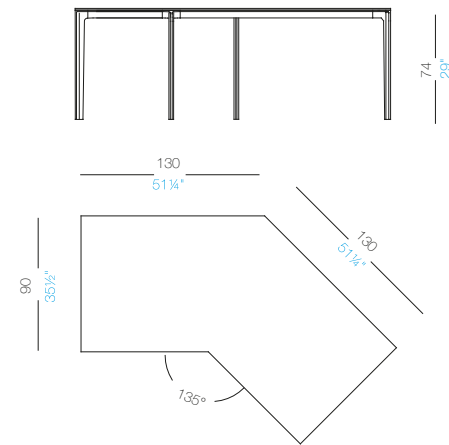
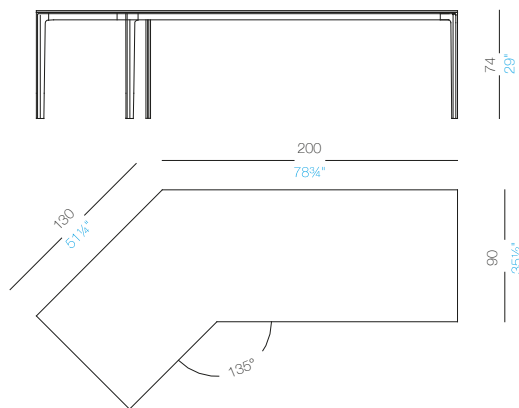
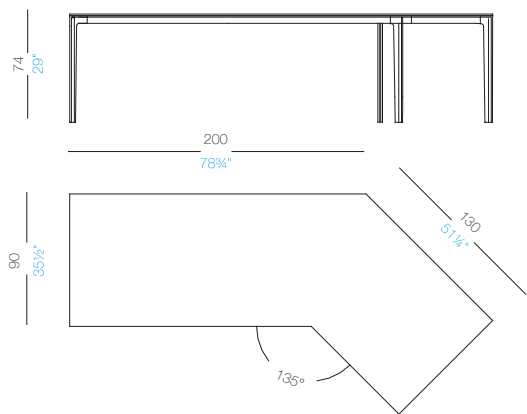

ADD T

Sample configuration

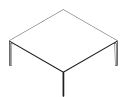

Square

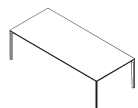

Rectangle

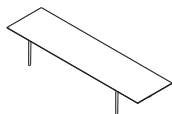

Rectangle extended

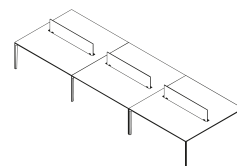

Linked

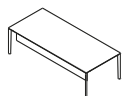

Modesty screen

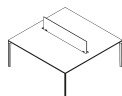

Privacy screen

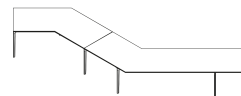

S_shape small

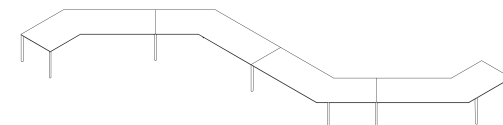

S_shape big

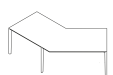

V_shape symmetric

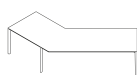

V_shape asymmetric

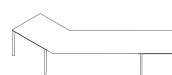

V_shape asymmetric extended

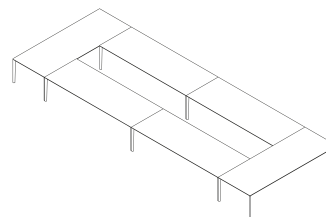

Rectangular conference

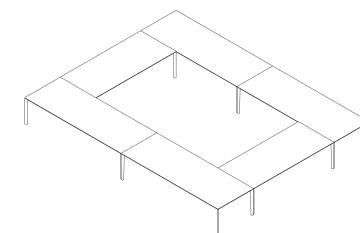

Square conference

ADD S

Francesco Rota | 2016











ADD S

Francesco Rota | 2016

ADD S

Sample configuration

Chest of drawers

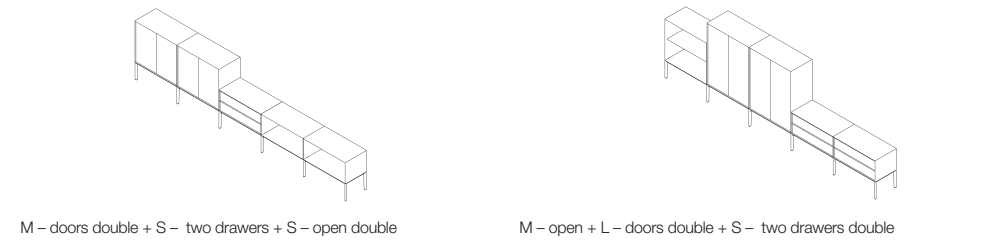
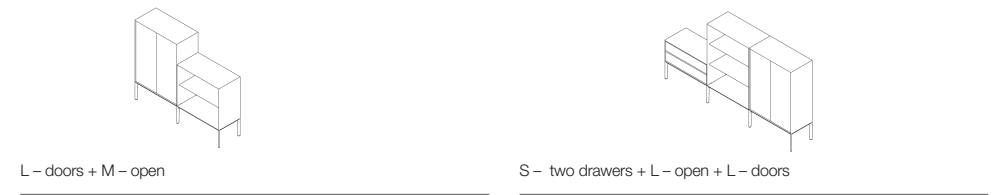
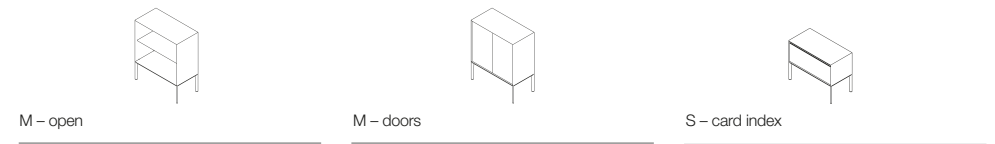
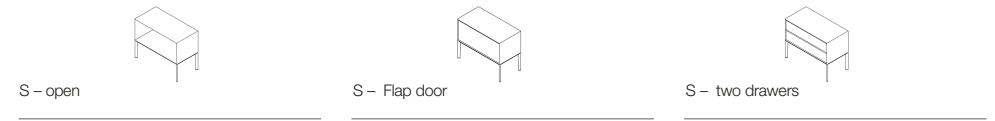
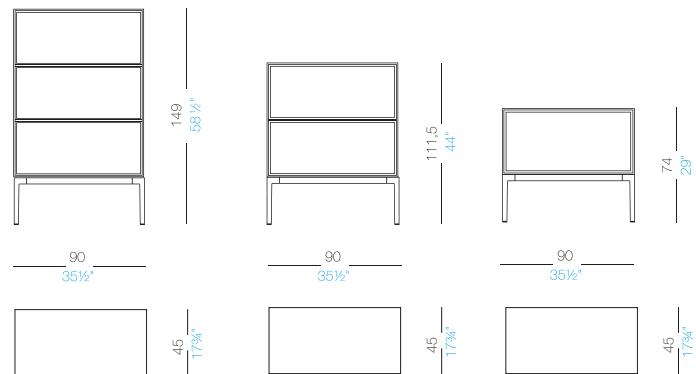
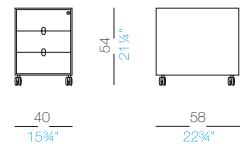

ADD SYSTEM

Francesco Rota | 2016

















ADD SYSTEM

Sample configuration

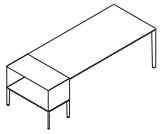

L_shape

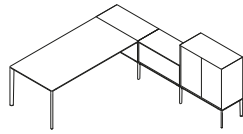

L_shape

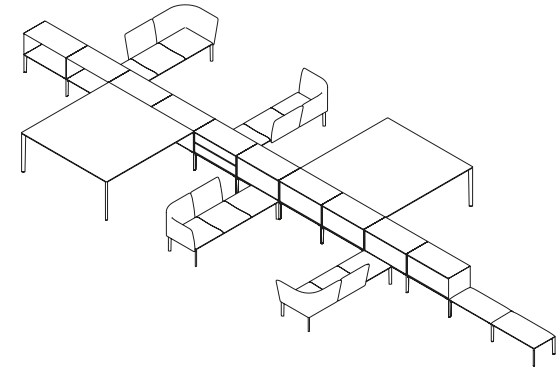

Symmetrical - square

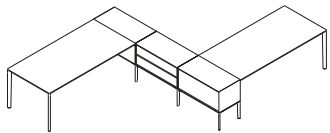

S_shape

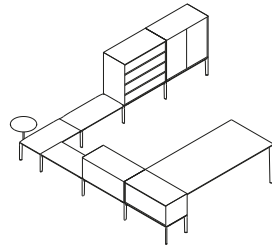

U_shape - executive

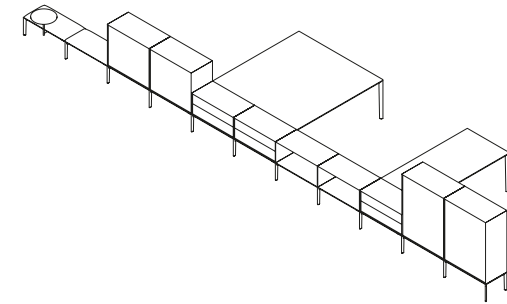

Asymmetrical task workstation 2

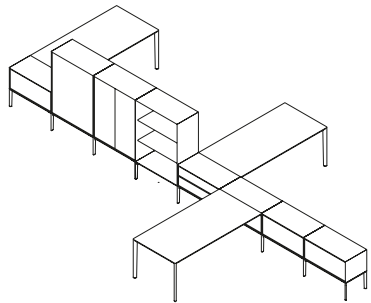

Asymmetrical task workstation 1

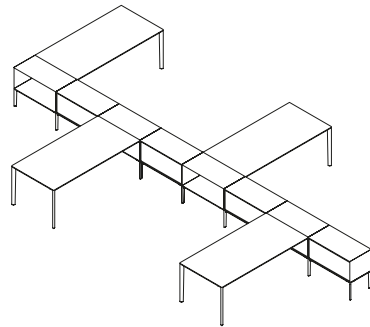

Symmetrical workstation - rectangle

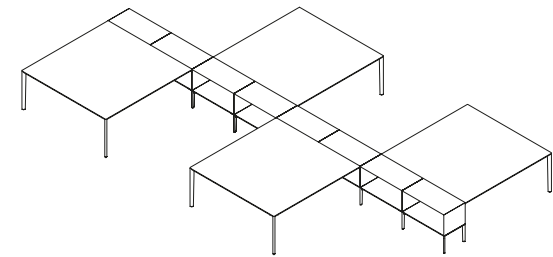

Symmetrical workstation - square

UNO

Francesco Rota | 2016















UNO

Francesco Rota | 2016

Guest

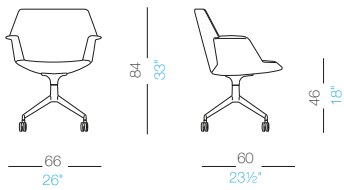
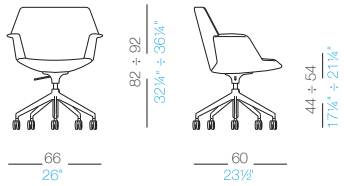
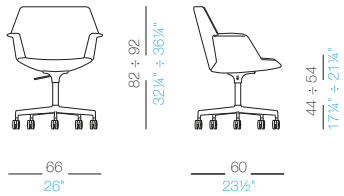

Task

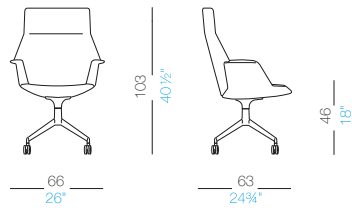
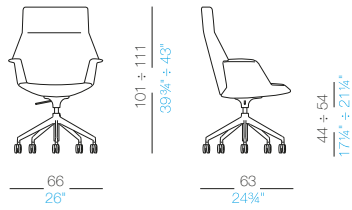
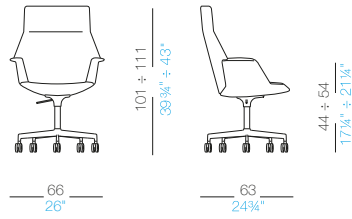

Executive

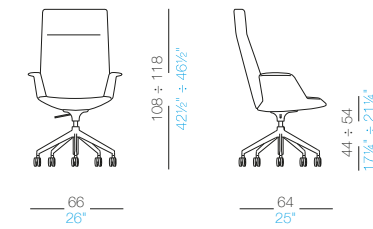
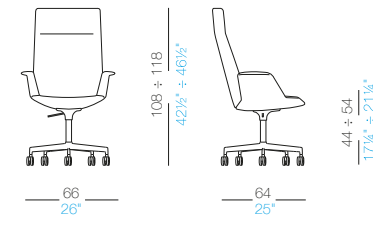
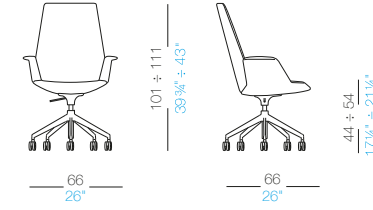
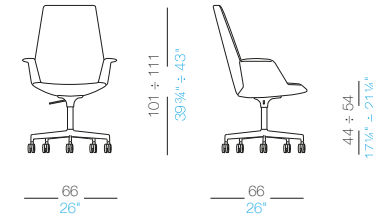

Lounge

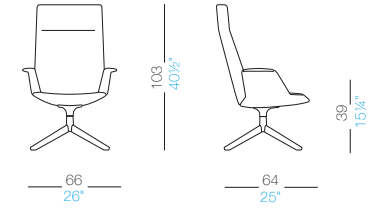
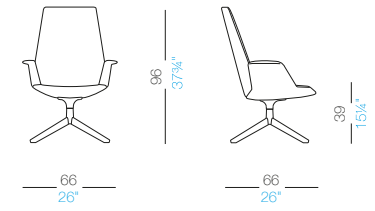

FRAME

Romano Marcato | 2007



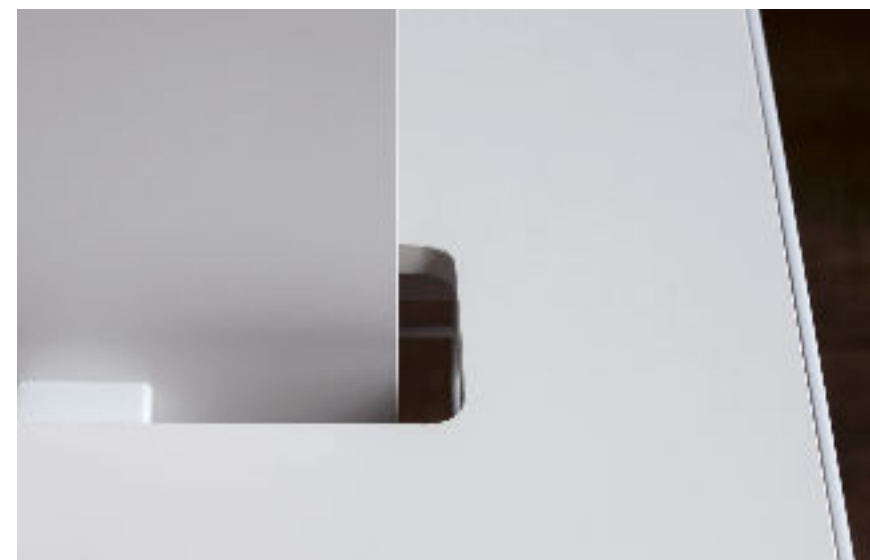





FRAME

Romano Marcato | 2007

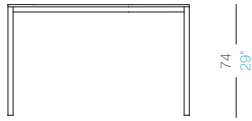

80
31 1/2"

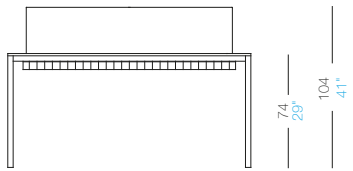

74
29"

104
41"

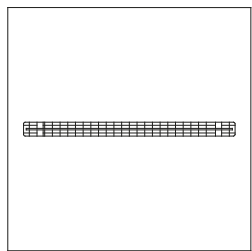

160
63"

160
63"



74
29"



80
31 1/2"

120 ÷ 160

47 1/2" ÷ 63"



74
29"



90
35 1/2"

180

71"

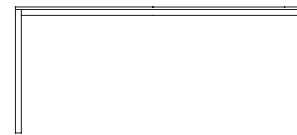

74
29"



100
39 1/4"

200

78 1/2"

SCREEN

Francesco Rota | 2016











SCREEN

Francesco Rota | 2016

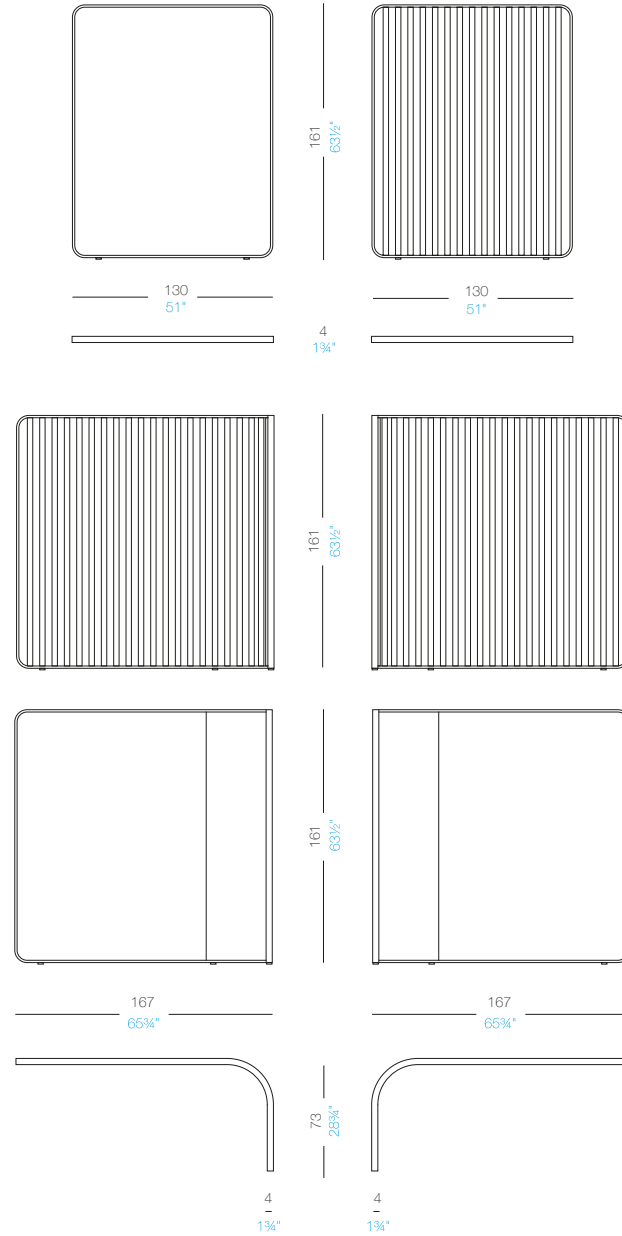
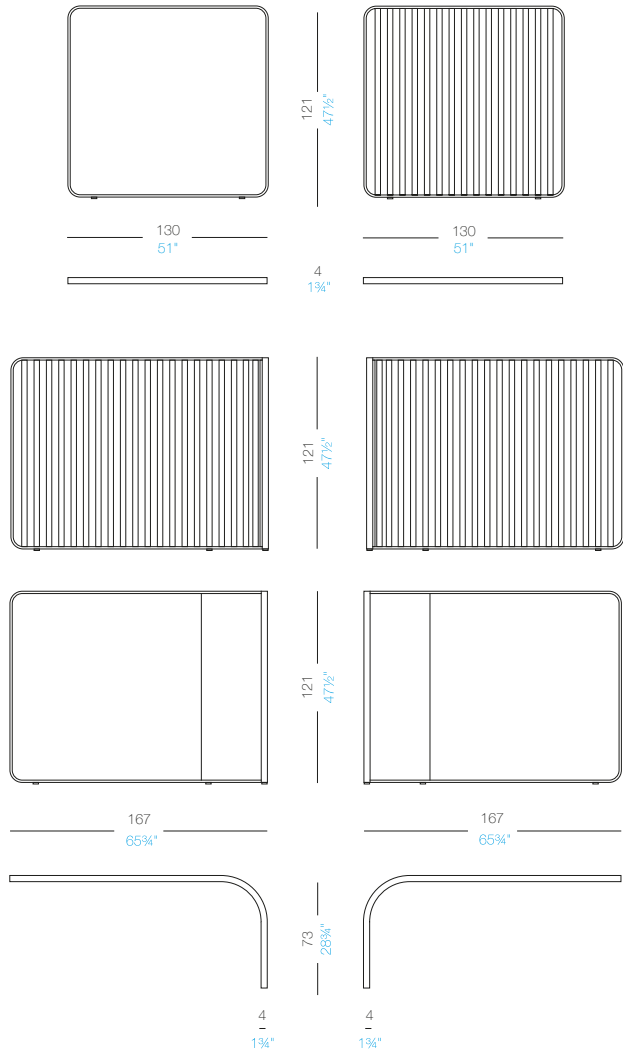

SCREEN

Sample configuration

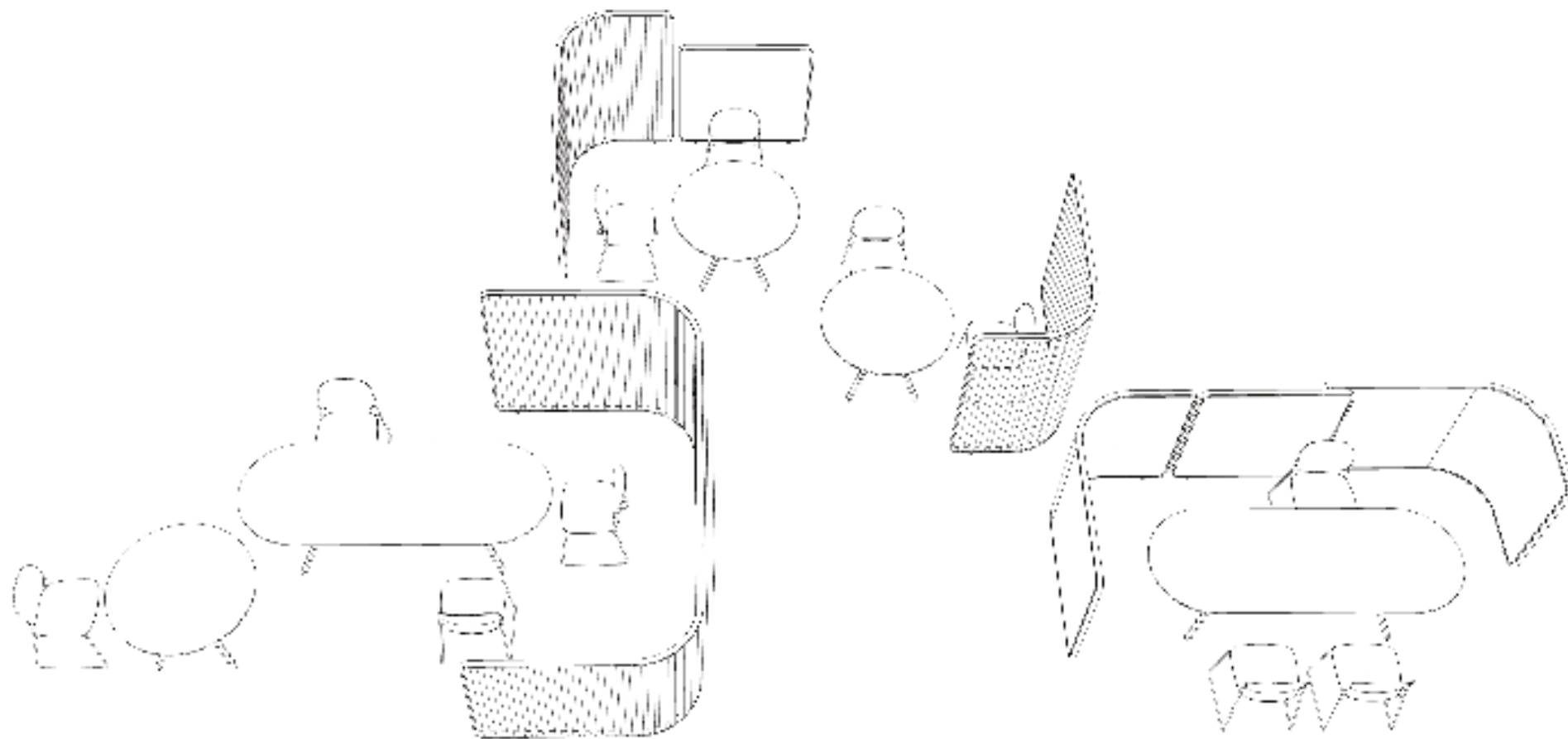

SCREEN

Sample configuration

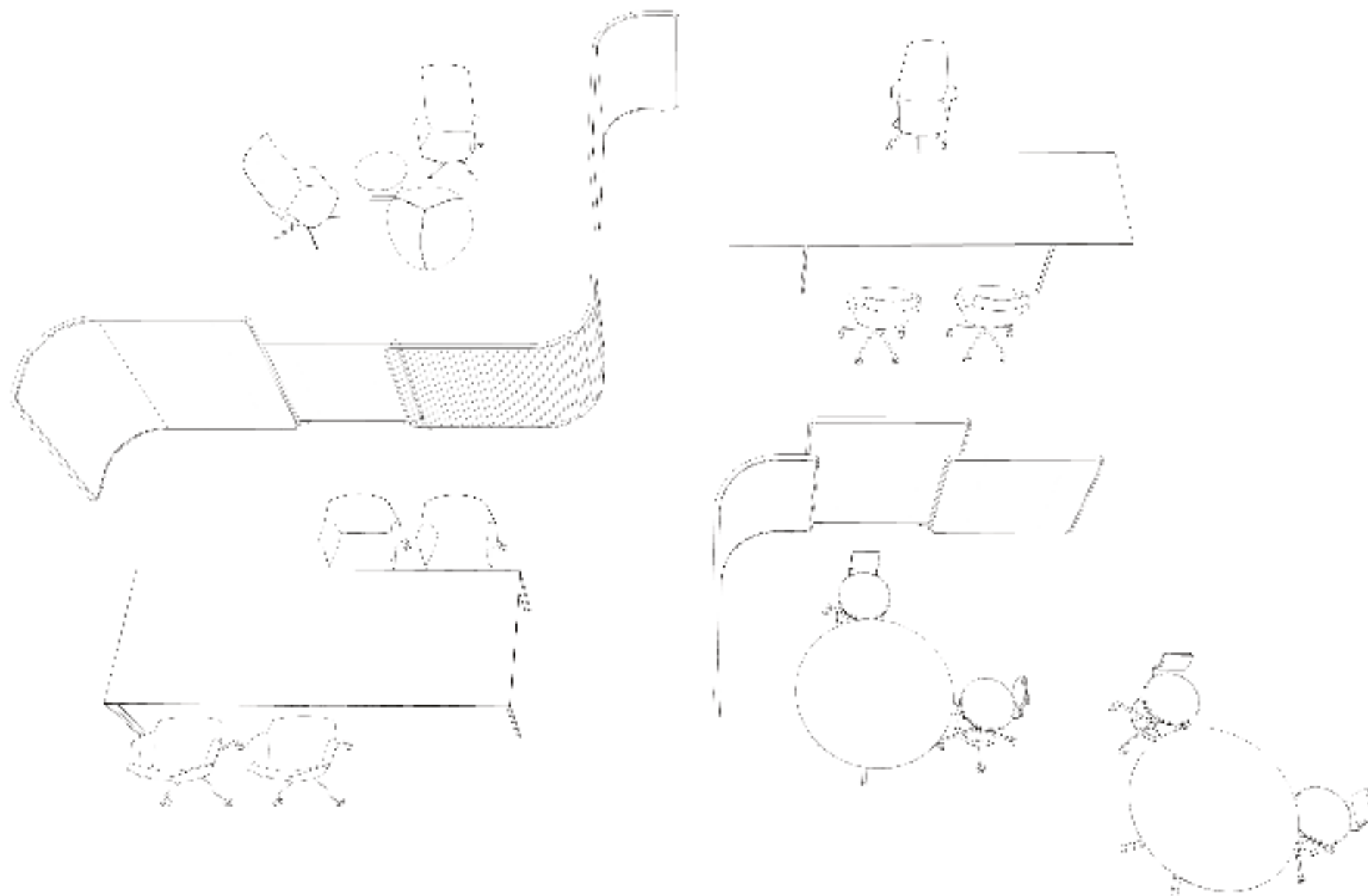

SCREEN

Sample configuration

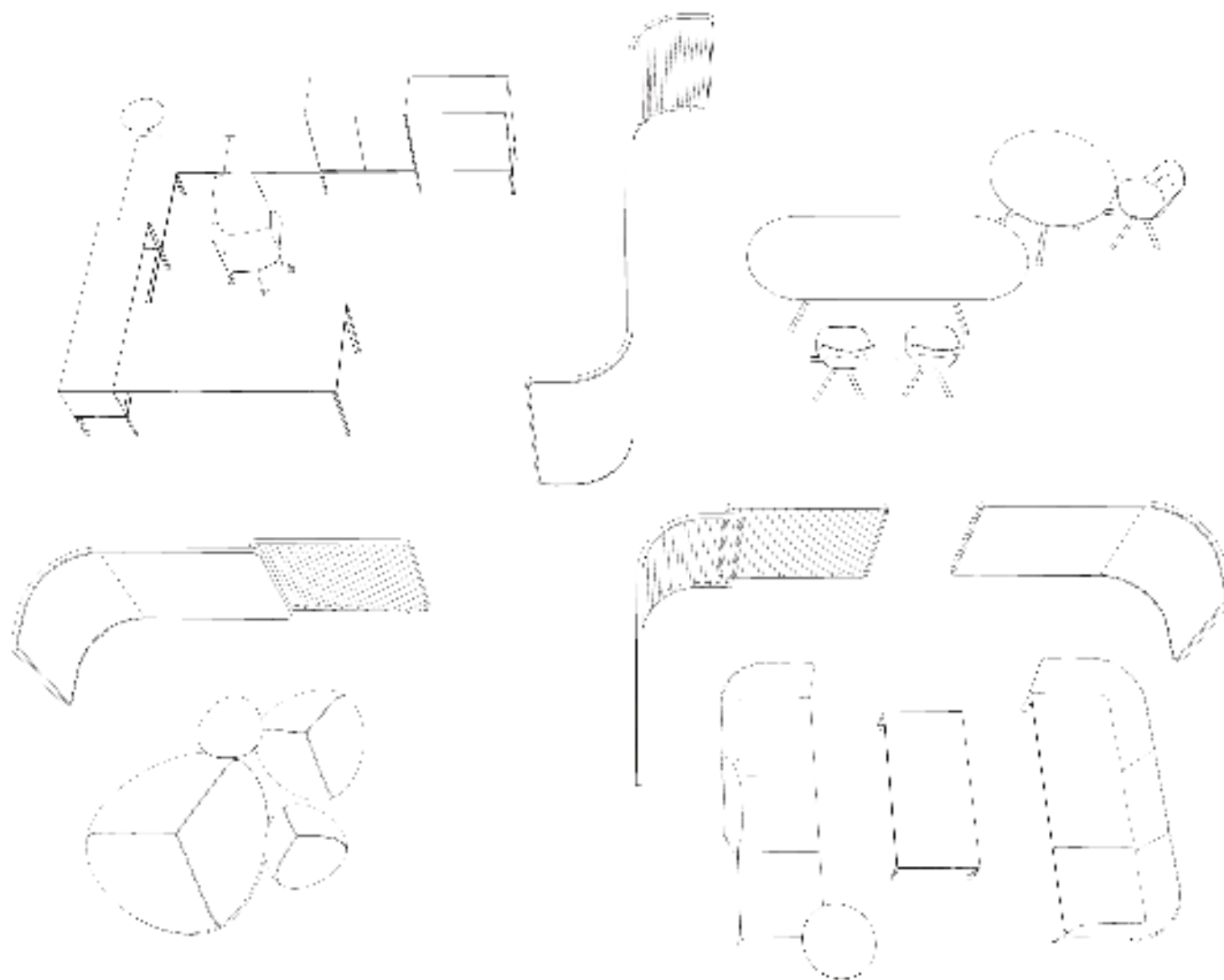

ZA SYSTEM

Shin & Tomoko Azumi | 2003







ZA SYSTEM

Shin & Tomoko Azumi | 2003

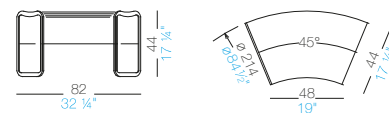
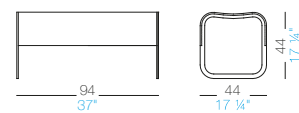
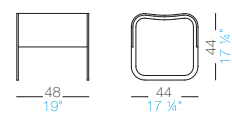

ZA SYSTEM

Sample configuration

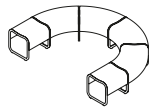

C_shape

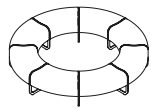

Round shape

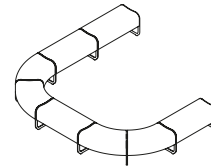

U_shape

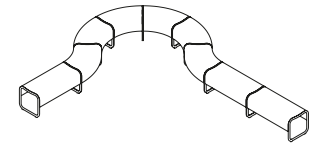

Corner shape

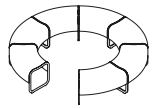

Rounde shape – open

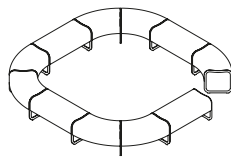

Square shape – open

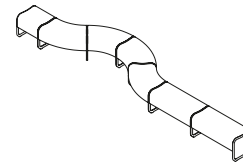

Bump shape

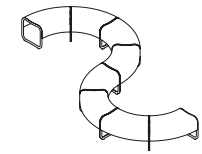

S_shape

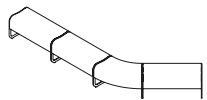

V_shape

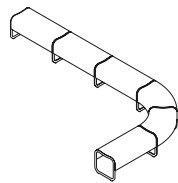

L_shape

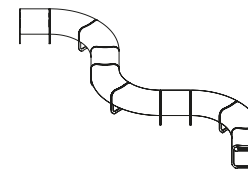

S_shape – double

KIPU

Anderssen & Voll | 2014







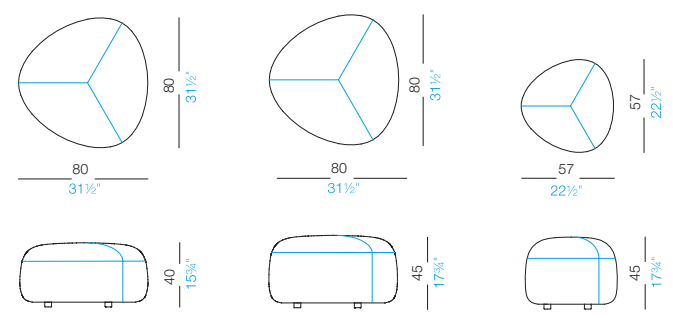
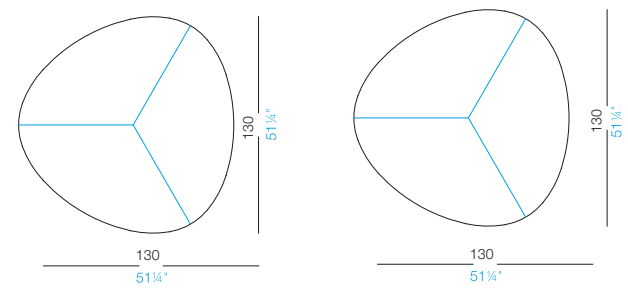

LAB

Karri Monni | 2014









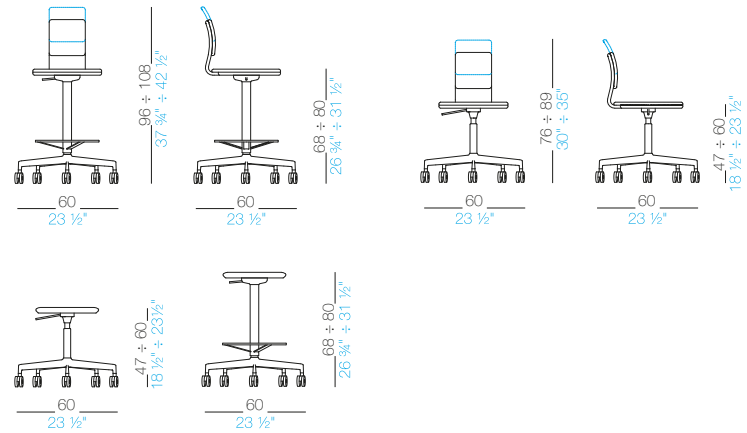

BRUNCH

Romano Marcato | 2012









BRUNCH

Romano Marcato | 2012

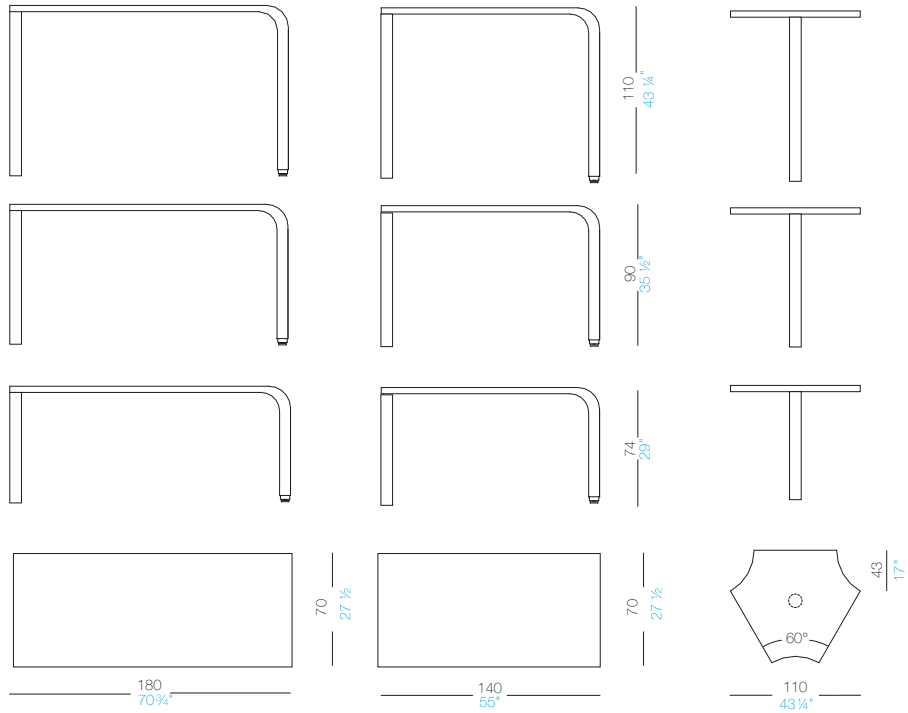

Accessories

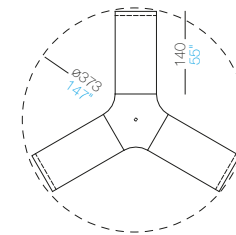
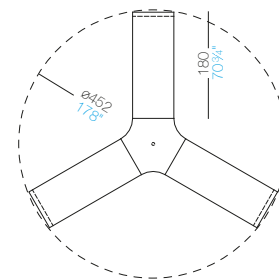
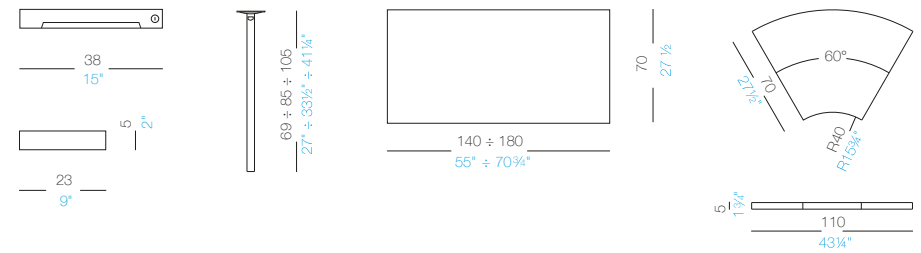

BRUNCH

Sample configuration

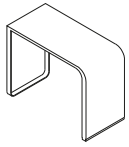

140

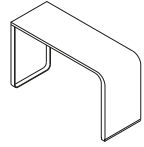

180

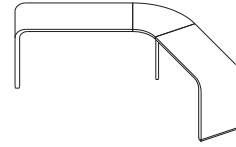

V_shape

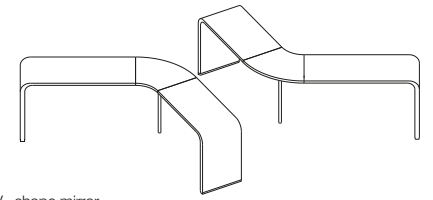

V_shape mirror

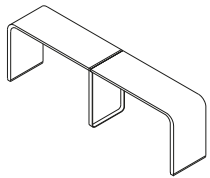

180 double

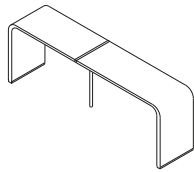

140 + 180

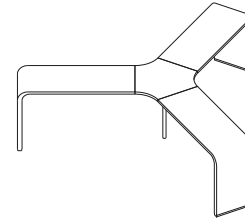

Y_shape big

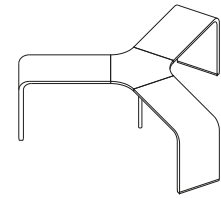

Y_shape small

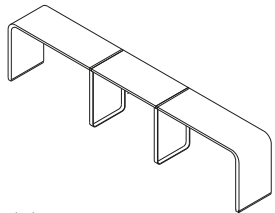

Double extended

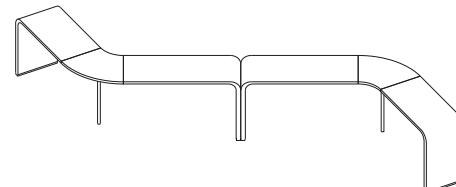

V_shape double

Designers

KIPU | 2014



Anderssen & Voll

Anderssen & Voll is an Oslo based design-studio run by Torbjørn Anderssen (1976) and Espen Voll (1965). Torbjørn is graduated from The Bergen Academy of Art and Design and Espen is graduated from Oslo National Academy of the Arts. As cofounders of Norway Says in 2000, they were forerunners in a emerging international movement amongst young Norwegian designers. Since the startup of Anderssen & Voll in 2009, their work has spanned from textile design through tableware, lighting and furniture to electronics for some of Europe's most renowned international design Brands. Their collaborations include work for companies like Lapalma, Muuto, Wrong for Hay, Foscarini, Kvadrat, Erik Jørgensen and Filip Technologies. They also take great pride in working with some of the finest Norwegian traditional industry like Jøtul, Gudbrandsdalens Uldvarefabrik, Fjord Fiesta, Roros Tweed and LK Hjelte. Working with the very different industrial cultures spanning from the mountains of Norway to the plains of Veneto is a continuous source of inspiration. Their work has received numerous awards like Honorary Award for Design Excellence in Norway, Wallpaper Award, IF Award and the Torsten and Wanja Söderberg Prize.

ZA SYSTEM | 2003



Shin Azumi

Shin Azumi was born in Kobe, Japan in 1965, and is currently based in London, UK. After finishing his Master course at the Royal College of Art, London, in 1994, he started working as a design unit 'AZUMI'. In 2005, he established his own design office 'a studio', working with international clients such as; lapalma (IT), Magis (IT), Desalto (IT), Fredericia (DK), Tefal (FR), Authentics(DE), Itoki(JP), Formax (JP), TOA (JP), Case (UK), Habitat (UK) and others. Shin Azumi's works have received numerous design awards in Europe and in Japan, including; FX International Design Award "Product of the Year" (UK), V&A Homes & Gardens Classic Design Award (UK), Good Design Award Best one hundred (JP), Classic Innovation Award 'Best of the Best' (DE), etc. His works have been added to the collection of many museums including the Victoria & Albert Museum (UK), Stedelijk Museum (Holland), Crafts-Council (UK), Die Neue Sammlung (Germany), Museum für Angewandte Kunst Frankfurt (Germany) as well as others. He is a visiting professor of Osaka University of Arts, and Kobe Design University and also a lecturer at Vitra Design Museum Workshops. Shin Azumi also has been part of in the judge on numerous design awards, such as; IF Design Award (DE), DT Design Award (JPN), Design Report Award (DE/IT), FX International Design Award (UK), Kokuyo Design Award (JPN), etc.

ZA SYSTEM | 2003



Tomoko Azumi

Tomoko Azumi (born in 1966, Hiroshima, Japan) is an interior and furniture designer based in London. She studied architecture and interior design at Kyoto City University of Art, worked in architectural studio in Tokyo, then moved to London in 1992. She finished a master course of Furniture Design at the Royal College of Art in 1995. After her activities as a partnership AZUMI (1995-2004), she started her own practice TNA Design Studio in East London in 2005. At TNA Design Studio, her main fields are furniture, lighting products, interior design and exhibition space design. She has been collaborating with international clients such as Benchmark Furniture (UK), Lapalma (Italy), Maxray (Japan), Röthlisberger (Switzerland) and Swarovski (Austria), as well as interior design for The Supreme Court of United Kingdom, shops for Harrys London and exhibition designs for the Crafts Council (UK). Her works are in several permanent collections include Victoria & Albert Museum and Geoffrey Museum in London and Stedelijk Museum (Netherlands). She has been a project teacher at the Design Products of Royal College of Art since 2005 and a research fellow at London Metropolitan University from 2006 to 2009. Also she is a member of jury for Good Design Award in Japan since 2006 and member of selection board for 100% Design London in 2010 and a member of jury for imm Design Award at the Cologne Furniture Fair on 2010 and 2011.

BRUNCH | 2012 FRAME | 2007



Romano Marcato

Born in Cadoneghe (Padova – Italy) in 1951. He got his degree in 1970 in mechanics at the Technical – Industrial Institute in Padova. From 1970 till 1978 he was in charge of planning high precision tools in an industry production moulds for high-speed trimmer for electrical connections. He also planned automatic machines to fix the connections in the car industry, electronics and domestic appliances. In 1979, together with his brother Dario, he founded Lapalma and designed some of the products: he is head of the technical department and in charge of prototyping, engineering and industrialisation of products.

LAB | 2014



Karri Monni

Karri Monni, born 1969 in Varkaus, Finland. Furniture carpenter studies 1985-1987. Studies in Lahti Institute of Design, in Department of Interior Architecture and Furniture Design 1994-1998, BA. Interior Architect and Designer, SIO. Practiced in Studio Simo Heikkilä; 1997, Industrial Design Ltd, Sistem 1998-1999, Keiski Architects 2000, Pekka Salminen Architects 2000. Started own Studio Karri Monni Oy 2006. Furniture designs for Lapalma from 2001. As a member of Interior Architects Monni & Koskivaara, furniture design /interior design work for Amer Sports, Nordea Bank Finland, Vacon, Sampo Group, Metso, Leiras Takeda Pharmaceutical, WinWinD, EFG, City of Helsinki, Roche, YLE, Valio, Walki, Aventis Pharma, McKinsey & Company. Karri Monni lives and works in Helsinki.

ADD SYSTEM | UNO | SCREEN | 2014-16



Francesco Rota

Francesco Rota, interior and product designer, born in 1966 in Milan where he lives and works. He graduated in product design at Art Center College of Design in 1994, La Tour de Peiz (Switzerland), he opens his own studio in 1998 and works in different fields of design: product, furniture, lighting, showrooms, offices, residential interiors and events. International collaborations: Alchemy, Arketipo, Bals Tokyo, Barilla, Triade, Fiat, Frag, John Richmond, Knoll International, KME Italy, Lapalma, Lema, Living Divani, L'Oreal Paris, Malo, Martini & Rossi, Mercedes Benz, Moroso, Paola Lenti, Oluce, Takano Co.Ltd, Versus. Francesco Rota has been honoured with many awards such as honorable mentions for the Compasso d'Oro, Special Mention for the German Design Award, Good Design Awards and Red Dot. He has taken part in several exhibitions held at: Triennale di Milano, Material Connection in New York, Biennale di Architettura di Venezia, Royal Academy of Arts in London. From 2013 he is the art director of Lapalma.

art direction

Francesco Rota

graphic design concept

Francesco Rota

photo

Adriano Brusaferrì
Bianca Puleo
Daniele Gobbin
Frank Schoepgens

styling

Lapalma
Sissi Valassina

text

Francesca Acerboni

layout

Anna Mascheroni

printed by

Grafiche Antiga

**Lapalma s.r.l.**

via Majorana 26
35010 Cadoneghe PD - Italy
T +39 049 702788
F +39 049 700889
info@lapalma.it
www.lapalma.it

